

ROBOTICS

Product manual

OmniCore C90XT



Trace back information:
Workspace 24A version a18
Checked in 2024-03-14
Skribenta version 5.5.019

Product manual
OmniCore C90XT

OmniCore

Document ID: 3HAC073706-001

Revision: Q

The information in this manual is subject to change without notice and should not be construed as a commitment by ABB. ABB assumes no responsibility for any errors that may appear in this manual.

Except as may be expressly stated anywhere in this manual, nothing herein shall be construed as any kind of guarantee or warranty by ABB for losses, damage to persons or property, fitness for a specific purpose or the like.

In no event shall ABB be liable for incidental or consequential damages arising from use of this manual and products described herein.

This manual and parts thereof must not be reproduced or copied without ABB's written permission.

Keep for future reference.

Additional copies of this manual may be obtained from ABB.

Original instructions.

© Copyright 2020-2024 ABB. All rights reserved.
Specifications subject to change without notice.

Table of contents

Overview of this manual	9
Product documentation	13
1 Safety	15
1.1 Safety information	15
1.1.1 Limitation of liability	15
1.1.2 Safety data	16
1.1.3 Requirements on personnel	17
1.2 Safety signals and symbols	18
1.2.1 Safety signals in the manual	18
1.2.2 Safety symbols on controller labels	20
1.3 Robot stopping functions	23
1.3.1 Protective stop and emergency stop	23
1.3.2 About emergency stop	25
1.3.3 Enabling device and hold-to-run functionality	26
1.4 Robot operating modes	27
1.4.1 About the manual mode	27
1.4.2 About the automatic mode	29
1.5 Safety during installation and commissioning	30
1.6 Safety during operation	33
1.7 Safety during maintenance and repair	34
1.8 Safety during troubleshooting	35
1.9 Safety during decommissioning	36
2 Controller description	37
2.1 OmniCore C90XT	37
2.2 Technical data for OmniCore C90XT controller	38
2.3 Safety functions and safety related data for OmniCore C90XT	43
2.4 The unit is sensitive to ESD	44
2.5 Handling of FlexPendant	46
2.6 Network security	47
2.7 Open source and 3rd party components	48
2.8 ABB Connected Services (ABB Ability)	49
3 Installation and commissioning	53
3.1 Introduction to installation and commissioning	53
3.2 Installation activities	54
3.3 Transporting and handling	55
3.3.1 Lifting the controller cabinet	55
3.3.2 Unpacking	56
3.3.3 Storing	57
3.4 On-site installation	58
3.4.1 Required installation space	58
3.4.2 Securing and stacking the controller cabinet	60
3.4.3 Mounting the FlexPendant holder	63
3.4.4 Connecting the Connected Services antenna	69
3.5 Electrical connections	70
3.5.1 Connectors on the OmniCore C90XT controller	70
3.5.2 Connecting cables to the controller	72
3.5.3 Connecting the manipulator to the controller	79
3.5.4 Fitting the connector for incoming mains	80
3.5.5 Connecting incoming mains and protective earth to the controller	83
3.5.6 Detaching and attaching a FlexPendant	87
3.5.7 Ethernet networks on OmniCore	90
3.5.8 Descriptions for connectors	92
3.5.9 Configuring robot stopping functions	106

Table of contents

3.5.10	Programmable stop functions	110
3.6	I/O system	113
3.6.1	Available industrial networks	113
3.6.2	Scalable I/O, internal and external	115
3.7	Installing options	116
3.7.1	Installing the harness for double SMB	116
3.7.2	Installing the scalable I/O devices	120
3.7.3	Installing the Ethernet extension switch	123
3.7.4	Installing the power supply optional device	126
3.7.5	Installing the fieldbus adapter slave devices	130
3.7.6	Installing the fieldbus master	133
3.7.7	Installing the conveyor tracking module	145
3.7.8	Installing the cable grommet assembly	148
3.7.9	Installing the filter	154
3.8	Installing add-on devices	156
3.8.1	Installing the extension box	156
3.8.2	Installing the conveyor tracking module to extension box	161
3.9	Installing external devices	164
3.10	Initial test before commissioning	165
4	Maintenance	167
4.1	Maintenance schedule for the OmniCore controller	167
4.2	Inspection activities	169
4.2.1	Inspection of controller	169
4.3	Cleaning activities	170
4.3.1	Cleaning air filter	170
4.3.2	Cleaning of the controller cabinet	172
4.3.3	Cleaning the FlexPendant	173
4.4	Changing/replacing activities	175
4.4.1	Replacement of air filter	175
4.5	Function tests	178
4.5.1	Function test of emergency stop	178
4.5.2	Function test of manual, auto, and manual full speed mode with FlexPendant	179
4.5.3	Function test of three-position enabling device	180
4.5.4	Function test of safety switches	181
4.5.5	Function test of Automatic Stop	182
4.5.6	Function test of General Stop	183
4.5.7	Function test of external emergency stop	184
4.5.8	Function test of ESTOP_STATUS output	185
4.5.9	Function test of reduced speed control	186
5	Repair	187
5.1	Introduction to repair	187
5.2	Replacement of controller parts	188
5.2.1	Opening the robot controller	188
5.2.2	Replacing the axis computer	190
5.2.3	Replacing the fans	196
5.2.3.1	Replacing the standard fans	197
5.2.3.2	Replacing the heat exchanger	201
5.2.3.3	Replacing the main computer fan	207
5.2.4	Replacing the robot signal exchange proxy	216
5.2.5	Replacing the Ethernet switch (DSQC1035)	222
5.2.6	Replacing the 3G Connected Services gateway	226
5.2.7	Replacing the scalable I/O unit	234
5.2.8	Replacing the safety digital base device	239
5.2.9	Replacing the main computer	243
5.2.10	Replacing the power unit	272
5.2.11	Replacing the power supply	277
5.2.12	Replacing the drive unit	284

5.2.13	Replacing the fieldbus master	292
5.2.14	Replacing the conveyor tracking module (CTM)	306
5.2.15	Replacing the air filter	311
5.3	Replacing parts on the panels	315
5.3.1	Replacing the manipulator signal connector (SMB)	315
5.3.2	Replacing the motor connector	319
5.3.2.1	Replacing the motor connector	321
5.3.3	Replacing the fieldbus adapter slave	325
5.3.4	Replacing the incoming mains connector	330
5.3.5	Replacing the HMI signal (FlexPendant) connector	334
5.3.6	Replacing the cable grommet assembly	340
5.3.7	Replacing the cable grommet assembly	349
5.3.8	Replacing the Ethernet outlet connector with cable	358
5.3.9	Replacing the LED indicator	364
5.4	Replacing parts on the FlexPendant	370
5.4.1	Replacing the power cable and power cable cover	370
5.4.2	Replacing the joystick protection	375
5.4.3	Replacing the fasten strip	378
6	Decommissioning	379
6.1	Introduction to decommissioning	379
6.2	Environmental information	380
7	Troubleshooting	383
7.1	Introduction to troubleshooting	383
7.2	Troubleshooting fault symptoms	385
7.2.1	No LEDs are lit on the controller	386
7.2.2	Start-up failure	389
7.2.3	System update failure	392
7.2.4	Problem releasing the robot brakes	393
7.2.5	Problem starting or connecting the FlexPendant	397
7.2.6	Problem using the joystick	401
7.2.7	Controller fails to start	402
7.2.8	Reflashing firmware failure	403
7.2.9	Inconsistent path accuracy	404
7.2.10	Controller is overheated	406
7.3	Troubleshooting units	407
7.3.1	Troubleshooting LEDs in the controller	407
7.3.2	Troubleshooting the FlexPendant	408
7.3.3	Troubleshooting the drive unit	409
7.3.4	Troubleshooting the power unit	411
7.3.5	Troubleshooting fieldbuses and I/O	416
7.3.6	Troubleshooting the 3G Connected Services gateway	417
7.3.7	Troubleshooting the Ethernet switch (DSQC1035)	423
7.3.8	Troubleshooting the axis computer	425
7.3.9	Troubleshooting the main computer	427
7.3.10	Troubleshooting the power supply	430
7.3.11	Troubleshooting the process power supply	435
7.3.12	Troubleshooting the fieldbus adapter slave	436
7.3.13	Troubleshooting the robot signal exchange proxy	438
8	Reference information	445
8.1	Introduction	445
8.2	Applicable standards	446
8.3	Unit conversion	447
8.4	Standard toolkit for controller	448
8.5	Screw joints	449
8.6	Weight specifications	450

Table of contents

8.7	Lifting accessories and lifting instructions	451
9	Spare parts	453
9.1	Controller parts	454
9.1.1	Controller system parts	455
9.1.2	Mains connection parts	458
9.1.3	Logic parts	459
9.1.4	Application parts	462
9.1.5	Cabinet parts	466
9.1.6	Miscellaneous parts	470
9.1.7	Cables	475
9.2	FlexPendant parts	476
9.3	Manipulator cables	477
9.3.1	Manipulator cables	477
9.3.2	Customer cables - CP/CS connectors (option)	478
9.3.3	Customer cables - Ethernet floor cables	479
Index		481

Overview of this manual

About this manual

This manual contains instructions for:

- mechanical and electrical installation of the controller
- maintenance of the controller
- mechanical and electrical repair of the controller

Usage

This manual should be used during:

- installation and commissioning, from lifting the product to its work site and securing it to the foundation, to making it ready for operation
- maintenance work
- repair work
- decommissioning work



Note

It is the responsibility of the integrator to conduct a risk assessment of the final application.

It is the responsibility of the integrator to provide safety and user guides for the robot system.

Who should read this manual?

This manual is intended for:

- installation personnel
- maintenance personnel
- repair personnel.

Prerequisites

A maintenance/repair/installation craftsman working with an ABB robot must:

- be trained by ABB and have the required knowledge of mechanical and electrical installation/repair/maintenance work.
- be trained to respond to emergencies or abnormal situations.

References



Tip

All documents can be found via myABB Business Portal, www.abb.com/myABB.

Document name	Document ID
<i>Product specification - OmniCore C line</i>	3HAC065034-001
<i>Circuit diagram - OmniCore C90XT</i>	3HAC065464-009

Continues on next page

Overview of this manual

Continued

Document name	Document ID
Operating manual - RobotStudio	3HAC032104-001
Operating manual - OmniCore	3HAC065036-001
Operating manual - Integrator's guide OmniCore	3HAC065037-001
Technical reference manual - System parameters	3HAC065041-001
Application manual - Connected Services	3HAC028879-001
Application manual - Conveyor tracking	3HAC066561-001
Application manual - Force control with software and hardware	3HAC070206-001
Application manual - Functional safety and SafeMove	3HAC066559-001

Revisions

Revision	Description
A	First edition.
B	Published in release 20C. The following updates are made in this revision: <ul style="list-style-type: none">• Updated information about safety data.• Updated information about robot signal exchange proxy.
C	Published in release 20D. The following updates are made in this revision: <ul style="list-style-type: none">• Section Mounting the FlexPendant holder on page 63 has been updated with new installation method for the FlexPendant holder.• Section "Network connections on the OmniCore" has been updated with NOTE regarding correct usage of the MGMT port.
D	Published in release 21A. The following updates are made in this revision: <ul style="list-style-type: none">• Minor corrections in section "Connections on the main computer".• Added extension cable spare parts in section FlexPendant parts on page 476.• Minor corrections in section Descriptions for connectors on page 92.
E	Published in release 21B. The following updates are made in this revision: <ul style="list-style-type: none">• Added information about general stop (GS) in section Descriptions for connectors on page 92.• Updated the information for configuration of safety stops, see Configuring robot stopping functions on page 106.• Updated FlexPendant holder assembling procedure.• Updated information about safety data.• Updated images related to general stop.
F	Published in release 21C. The following updates are made in this revision: <ul style="list-style-type: none">• Deleted the 30 m signal cable for IRB 1300, see Manipulator cables on page 477.• Added information, see AC current in CP/CS on page 73.• Sections "Network connections on OmniCore" and "Set up the network connection" replaced by Ethernet networks on OmniCore on page 90.• Update content for ESOUT in section Descriptions for connectors on page 92.

Continues on next page

Revision	Description
G	<p>Published in release 21D. The following updates are made in this revision:</p> <ul style="list-style-type: none"> • Added information about safety digital base device. • Added information about main computer fan. • Added supported robot IRB 1200, 910INV and 920. • Updated structure in section Descriptions for connectors on page 92. • Updated structure in section Controller parts on page 454. • Updated the section Ethernet networks on OmniCore on page 90.
H	<p>Published in release 22A. The following updates are made in this revision:</p> <ul style="list-style-type: none"> • Added information on decoupling ES output and ES input, see Descriptions for connectors on page 92, and Configuring robot stopping functions on page 106. • Part numbers for mating connectors corrected in Robot signal exchange proxy mating connectors on page 92. • Information about I/O Network added in section "Firewall settings".
J	<p>Published in release 22B. The following updates are made in this revision:</p> <ul style="list-style-type: none"> • Minor corrections in section Descriptions for connectors on page 92. • Added note that the content of the section ABB Ability is only available in English (also in translated manuals). • Added related information that the approval code CMIIT ID is finally displayed on the nameplate of the product in section Troubleshooting the 3G Connected Services gateway on page 417. • Updated manipulator cables in section Manipulator cables on page 477. • Information added in section Available industrial networks on page 113 that two industrial network masters can be run in parallel on the OmniCore controller.
K	<p>Published in release 22C. The following updates are made in this revision:</p> <ul style="list-style-type: none"> • Updated the section Controller fails to start on page 402. • Added supported robot CRB 1300. • Updated K2.X7, K2.X22 harness image. • Sections Disconnecting the antenna on page 227 and Reconnecting the antenna on page 232 updated, plus new section Connecting the Connected Services antenna on page 69. • Updated the section Airborne noise level on page 41.
L	<p>Published in release 22D. The following updates are made in this revision:</p> <ul style="list-style-type: none"> • Minor corrections in Connecting incoming mains and protective earth to the controller on page 83. • Added note about voltage for activation of emergency stop and protective stop, see Connector X14 on page 92. • Added section about securing and stacking the controller cabinet, see Securing and stacking the controller cabinet on page 60.
M	<p>Published in release 23A. The following updates are made in this revision:</p> <ul style="list-style-type: none"> • Minor updates in section Troubleshooting the 3G Connected Services gateway on page 417. • Changed the name from "Load Current" to "Line fusing" in section Technical data for OmniCore C90XT controller on page 38.
N	<p>Published in release 23B. The following updates are made in this revision:</p> <ul style="list-style-type: none"> • New spare parts added in Vision parts on page 473. • Phased out the fan spare parts standard fan (3HAC059214-001). • FCC statement added in ABB Connected Services (ABB Ability) on page 49.

Continues on next page

Overview of this manual

Continued

Revision	Description
P	Published in release 23C. The following updates are made in this revision: <ul style="list-style-type: none">• FCC statement updated in ABB Connected Services (ABB Ability) on page 49.• Minor corrections.
Q	Published in release 24A. The following updates are made in this revision: <ul style="list-style-type: none">• ABB Connect is the new name for ABB Ability Connected Services.• Updated protection class of FlexPedant in section Protection classes on page 40.• Updated spare part number of FlexPedant in section FlexPendant parts on page 476.

Product documentation

Categories for user documentation from ABB Robotics

The user documentation from ABB Robotics is divided into a number of categories. This listing is based on the type of information in the documents, regardless of whether the products are standard or optional.



Tip

All documents can be found via myABB Business Portal, www.abb.com/myABB.

Product manuals

Manipulators, controllers, DressPack, and most other hardware is delivered with a **Product manual** that generally contains:

- Safety information.
- Installation and commissioning (descriptions of mechanical installation or electrical connections).
- Maintenance (descriptions of all required preventive maintenance procedures including intervals and expected life time of parts).
- Repair (descriptions of all recommended repair procedures including spare parts).
- Calibration.
- Troubleshooting.
- Decommissioning.
- Reference information (safety standards, unit conversions, screw joints, lists of tools).
- Spare parts list with corresponding figures (or references to separate spare parts lists).
- References to circuit diagrams.

Technical reference manuals

The technical reference manuals describe reference information for robotics products, for example lubrication, the RAPID language, and system parameters.

Application manuals

Specific applications (for example software or hardware options) are described in **Application manuals**. An application manual can describe one or several applications.

An application manual generally contains information about:

- The purpose of the application (what it does and when it is useful).
- What is included (for example cables, I/O boards, RAPID instructions, system parameters, software).
- How to install included or required hardware.
- How to use the application.

Continues on next page

- Examples of how to use the application.

Operating manuals

The operating manuals describe hands-on handling of the products. The manuals are aimed at those having first-hand operational contact with the product, that is production cell operators, programmers, and troubleshooters.

1 Safety

1.1 Safety information

1.1.1 Limitation of liability

Limitation of liability

Any information given in this manual regarding safety must not be construed as a warranty by ABB that the industrial robot will not cause injury or damage even if all safety instructions are complied with.

The information does not cover how to design, install and operate a robot system, nor does it cover all peripheral equipment that can influence the safety of the robot system.

In particular, liability cannot be accepted if injury or damage has been caused for any of the following reasons:

- Use of the robot in other ways than intended.
- Incorrect operation or maintenance.
- Operation of the robot when the safety devices are defective, not in their intended location or in any other way not working.
- When instructions for operation and maintenance are not followed as intended.
- Non-authorized design modifications of the robot.
- Repairs on the robot and its spare parts carried out by in-experienced or non-qualified personnel.
- Foreign objects.
- Force majeure.

Spare parts and equipment

ABB supplies original spare parts and equipment which have been tested and approved for their intended use. The installation and/or use of non-original spare parts and equipment can negatively affect the safety, function, performance, and structural properties of the robot. ABB is not liable for damages caused by the use of non-original spare parts and equipment.

1 Safety

1.1.2 Safety data

1.1.2 Safety data

Prevailing standards and directives

For the use of industrial robots, regulations must be fulfilled as described in the following standards and directives:

- EN ISO 10218-1:2011
- Machinery Directive 2006/42/EC

Performance level and category

EN ISO 10218-1 requires structure category 3 and performance level *PL d* on the robot, see EN ISO 13849-1.

Risk assessment

The results of a risk assessment performed on the robot and its intended application may determine that a safety-related control system performance other than that stated in ISO 10218 is warranted for the application.

The SISTEMA/ABB FSDT libraries contains details for the safety functions.



Note

The safety functions are divided into two types called *Basic Safety Functions* and *Extended Safety Functions*.

Performance level data

The performance level data for the respective controller variant is presented in section [Safety functions and safety related data for OmniCore C90XT on page 43](#).

1.1.3 Requirements on personnel

General

Only personnel with appropriate training are allowed to install, maintain, service, repair, and use the robot. This includes electrical, mechanical, hydraulics, pneumatics, and other hazards identified in the risk assessment.

Persons who are under the influence of alcohol, drugs or any other intoxicating substances are not allowed to install, maintain, service, repair, or use the robot.

The plant liable must make sure that the personnel is trained on the robot, and on responding to emergency or abnormal situations.

Personal protective equipment

Use personal protective equipment, as stated in the instructions.

1 Safety

1.2.1 Safety signals in the manual

1.2 Safety signals and symbols

1.2.1 Safety signals in the manual







Introduction to safety signals

This section specifies all safety signals used in the user manuals. Each signal consists of:

- A caption specifying the hazard level (DANGER, WARNING, or CAUTION) and the type of hazard.
- Instruction about how to reduce the hazard to an acceptable level.
- A brief description of remaining hazards, if not adequately reduced.

Hazard levels

The table below defines the captions specifying the hazard levels used throughout this manual.

Symbol	Designation	Significance
	DANGER	Signal word used to indicate an imminently hazardous situation which, if not avoided, will result in serious injury.
	WARNING	Signal word used to indicate a potentially hazardous situation which, if not avoided, could result in serious injury.
	ELECTRICAL SHOCK	Signal word used to indicate a potentially hazardous situation related to electrical hazards which, if not avoided, could result in serious injury.
	CAUTION	Signal word used to indicate a potentially hazardous situation which, if not avoided, could result in slight injury.
	ELECTROSTATIC DISCHARGE (ESD)	Signal word used to indicate a potentially hazardous situation which, if not avoided, could result in severe damage to the product.
	NOTE	Signal word used to indicate important facts and conditions.

Continues on next page

Symbol	Designation	Significance
	TIP	Signal word used to indicate where to find additional information or how to do an operation in an easier way.

1 Safety

1.2.2 Safety symbols on controller labels

1.2.2 Safety symbols on controller labels

Introduction to safety symbols

Both the manipulator and the controller are marked with labels containing safety symbols and important information about the product. The purpose of the labels is to ensure personal safety for all personnel handling the robot, for example during installation, service, or operation.

The safety symbols are language independent, they only use graphics. The information labels contain information in text. See [Symbols and information on labels on page 20](#).



Note



The safety and information labels on the product must be observed.

Symbols and information on labels







Note

The descriptions in this section are generic, the labels can contain additional information such as values.

Label	Description
 xx1400001152	Read the user manual before use.
 xx2100000104	The robot is delivered to start in automatic mode
 xx1800000835	CE label

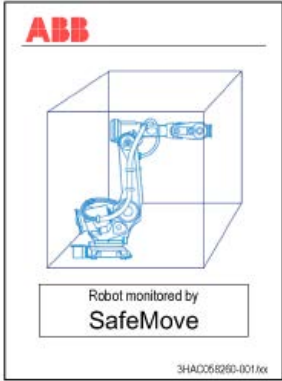
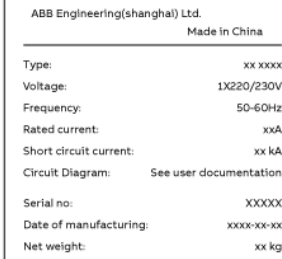

Continues on next page

Label	Description
 <p>xx1400002061</p>	<p>UL certified (robot with controller)</p>
 <p>xx1700000353</p>	<p>Safety UL label (for the <i>Functional Safety</i> solution together with UL mark).</p>
 <p>xx1700000355</p>	<p>SafeMove label (for <i>SafeMove Basic</i> and <i>SafeMove Pro</i> software).</p>
 <p>xx1900001805</p>	<p>Rating label (example)</p>
 <p>xx1400001151</p>	<p>Electrical shock</p>

1 Safety

1.2.2 Safety symbols on controller labels

Continued

Label	Description
 <p>xx1800000836</p>	Warning & caution label
 <p>xx1400001156</p>	High voltage inside the module even if the main switch is in the OFF position.
 <p>xx1400001162</p>	ESD sensitive components inside the controller.

1.3 Robot stopping functions

1.3.1 Protective stop and emergency stop

Robot stopping functions

The robot has protective and emergency stop functions (stop category 0 or 1, in accordance with IEC 60204-1).

Stop category 0	As defined in IEC 60204-1, stopping by immediate removal of power to the machine actuators.
Stop category 1	As defined in IEC 60204-1, a controlled stop with power available to the machine actuators to achieve the stop and then removal of power when the stop is achieved.

A stop function, protective or emergency stop, has a default setting for the stop category, see [Inputs to initiate a protective stop or an emergency stop on page 23](#).

The default stop category for a protective or emergency stop can be re-configured. Activation of external safety rated devices, connected to the robot controller through dedicated discrete safety inputs or safety protocols, will initiate these stop functions.

Inputs to initiate a protective stop or an emergency stop

Inputs to initiate a stop function	Description	Default stop category	Stop category reconfigurable
Emergency Stop (ES)	Input to initiate the emergency stop function. The <i>Emergency Stop</i> function is initiated in both automatic and manual mode.	Stop category 0 For deviations, see the product manual for the manipulator.	Yes
Automatic Stop and General Stop (AS/GS)	Input to initiate the protective stop function, which can be configured to be either <i>Automatic Stop</i> or <i>General Stop</i> . When configured as <i>Automatic Stop</i> , the protective stop function is only initiated in automatic mode. When configured as <i>General Stop</i> , the protective stop function is initiated in both manual mode and automatic mode.	Stop category 1	Yes



Note

For OmniCore, the default configuration for the protective stop function triggered by the protective stop input is *Automatic Stop*.

For example, a safety rated output from a presence sensing device, connected to AS / GS, a dedicated discrete protective stop input on the robot controller, will when the protective stop function is configured as Automatic Stop (AS) initiate the protective stop function in automatic mode only.

Continues on next page

1 Safety

1.3.1 Protective stop and emergency stop

Continued

The emergency stop function is a complementary protective measure and shall not be applied as a substitute for safeguarding measures or safety functions.



Note

For OmniCore, a safety input used to initiate a protective stop must remain active for at least 100 ms.

Stop category configuration for OmniCore

The stop category configuration is done in RobotStudio, in the tool *Visual Safety*.

1.3.2 About emergency stop

The emergency stop

The purpose of the emergency stop function is to avert actual or impending emergency situations arising from the behavior of persons or from an unexpected hazardous event.

The emergency stop function is to be initiated by a single human action.

The emergency stop function is a complementary protective measure and shall not be applied as a substitute for safeguarding measures and other functions or safety functions.

The effect of an activated emergency stop device is sustained until the actuator of the emergency stop device has been disengaged. This disengagement is only possible by an intentional human action on the device where the command has been initiated. The disengagement of the emergency stop device shall not restart the machinery but only permit restarting.



Note

The emergency stop device on the FlexPendant is operational when the robot is powered. Indicators to be used to verify that the robot is powered are the main switch on the cabinet or the LED indicator on the cabinet when robot is in Motors On Mode.

Recover from emergency stop

- 1 Inspect the machinery in order to detect the reason for the emergency stop device actuation.
- 2 Locate and disengage the emergency stop device or devices that initiated the emergency stop function.

1.3.3 Enabling device and hold-to-run functionality

Three-position enabling device



CAUTION

The person using the three-position enabling device is responsible to observe the safeguarded space for hazards due to robot motion and any other hazards related to the robot.

The three-position enabling device is located on the FlexPendant. When continuously held in center-enabled position, the three-position enabling device will permit robot motion and any hazards controlled by the robot. Release or compression past the center-enabled position will stop the robot motion.



CAUTION

For safe use of the three-position enabling device, the following must be implemented:

- The three-position enabling device must never be rendered inoperational in any way.
- If there is a need to enter safeguarded space, always bring the FlexPendant. This is to enforce single point of control.

Hold-to-run function in manual high speed mode

The hold-to-run function for manual high speed allows movement in conjunction with the three-position enabling device when the button connected to the function is actuated manually. This hold-to-run function can only be used in manual high speed mode. In case of hazard, release or compress the three-position enabling device.

How to use the hold-to-run function for manual high speed mode is described in the operating manual for the controller.

1.4 Robot operating modes

1.4.1 About the manual mode

The manual mode

Manual mode is a control state that allows for the direct control by an operator. The operator will through positioning the three-position enabling device to the center-position allow for movement of the manipulator.

There are two manual modes:

- Manual reduced speed
- Manual high speed (optional)

Safeguard mechanisms

Protective stop function initiated by

- Three-position enabling device (release of or compression past the center-enabled position)
- General Stop, GS (the dedicated input, GS, or the dedicated input AS/GS configured to GS, see actual controller)

The mode manual reduced speed

The mode manual reduced speed, is used for jogging, teaching, programming and program verification of the robot; it may be the mode selected when performing some maintenance tasks.

In manual reduced speed mode the movement of the TCP is limited to 250 mm/s. In addition, there is a limitation on the maximum allowed speed for each axis.

Manual control of the robot from inside the safeguarded space shall be performed through the FlexPendant.

**WARNING**

Wherever possible, the manual mode of operation shall be performed with all persons outside the safeguarded space.

Tasks normally performed in mode manual reduced speed

The following tasks are normally performed in manual reduced speed mode.

- Set or reset I/O signals
- Creating and editing RAPID programs
- Modify system parameter values
- Starting, stepping, and stopping program execution
- Jog the manipulator
- Teach or tune programmed manipulator positions

The mode manual high speed

The mode manual high speed, is used for program verification only.

Continues on next page

1 Safety

1.4.1 About the manual mode

Continued

The three-position enabling switch must be pressed to the center-position and the hold-to-run button must be pressed to allow start of program execution, for example, execute movement instructions.

In manual high speed, the initial speed of the movement, does not exceed 250 mm/s, that is limited to a percentage of the programmed speed. The speed can be manually adjusted in steps up to the programmed speed.

When the three-position enabling device is released or fully compressed, the speed is reset to the initial speed, that is, not exceeding 250 mm/s.



WARNING

Wherever possible, the manual mode of operation shall be performed with all persons outside the safeguarded space.

Tasks normally performed in mode manual high speed

The following tasks are normally performed in manual high speed mode.

- Program verification
- Setting program pointer (to Main, to routine, to cursor, to service routine, etc.)
- Starting and stopping program execution
- Stepping program execution
- Manually adjusting speed (0–100%)

1.4.2 About the automatic mode

The automatic mode

Automatic mode is an operating mode in which the robot operates in accordance with the task program(s).

Tasks normally performed in automatic mode

The following tasks are typically performed in automatic mode:

- Start and stop of program execution.
- Increase or decrease the speed in between zero and programmed speed.
- Restore backups. Only possible when robot is at stop.
- Load, start, stop, and modify RAPID programs through remote clients.

Safeguard mechanisms

Protective stop function initiated by

- Automatic Stop, AS (the dedicated input, AS, or the dedicated input AS/GS configured to AS, see actual controller)
- General Stop, GS (the dedicated input, GS, or the dedicated input AS/GS configured to GS, see actual controller)



Note

Prior to allowing the robot to operate in automatic mode, ensure that any suspended safeguards, are returned to full functionality.

1 Safety

1.5 Safety during installation and commissioning

1.5 Safety during installation and commissioning

National or regional regulations

The integrator of the robot system is responsible for the safety of the robot system.

The integrator is responsible that the robot system is designed and installed in accordance with the safety requirements set forth in the applicable national and regional standards and regulations.

The integrator of the robot system is required to perform a risk assessment.

Layout

The robot integrated to a robot system shall be designed to allow safe access to all spaces during installation, operation, maintenance, and repair.

If robot movement can be initiated from an external control panel then an emergency stop must also be available.

If the manipulator is delivered with mechanical stops, these can be used for reducing the working space.

A perimeter safeguarding, for example a fence, shall be dimensioned to withstand the following:

- The force of the manipulator.
- The force of the load handled by the robot if dropped or released at maximum speed.
- The maximum possible impact caused by a breaking or malfunctioning rotating tool or other device fitted to the robot.

The maximum TCP speed and the maximum velocity of the robot axes are detailed in the section *Robot motion* in the product specification for the respective manipulator.

Consider exposure to hazards, such as slipping, tripping, and falling.

Hazards due to the working position and posture for a person working with or near the robot shall be considered.

Hazards due to noise emission from the robot needs to be considered.

Consider hazards from other equipment in the robot system, for example, that guards remain active until identified hazards are reduced to an acceptable level.

Allergenic material

See [Environmental information on page 380](#) for specification of allergenic materials in the product, if any.

Securing the robot to the foundation

The robot must be properly fixed to its foundation/support, as described in the respective product manual.

When the robot is installed at a height, hanging, or other than mounted directly on the floor, there will be additional hazards.

Continues on next page

Using lifting accessories and other external equipment

Ensure that all equipment used during installation, service and all handling of the robot are in correct condition for the intended use.

Electrical safety

Incoming mains must be installed to fulfill national regulations.

The power supply wiring to the robot must be sufficiently fused and if necessary, it must be possible to disconnect it manually from the mains power.

The power to the robot must be turned off with the main switch and the mains power disconnected when performing work inside the controller cabinet. Lock and tag shall be considered.

Hazards due to stored electrical energy in the controller must be considered.

Harnesses between controller and manipulator shall be fixed and protected to avoid tripping and wear.

Wherever possible, power on/off or rebooting the robot controller shall be performed with all persons outside the safeguarded space.



Note

Use a CARBON DIOXIDE (CO₂) extinguisher in the event of a fire in the robot.

Safety devices

The integrator is responsible for that the safety devices necessary to protect people working with the robot system are designed and installed correctly.

When integrating the robot with external devices to a robot system:

- The integrator of the robot system must ensure that emergency stop functions are interlocked in accordance with applicable standards.
- The integrator of the robot system must ensure that safety functions are interlocked in accordance with applicable standards.

Other hazards

A robot may perform unexpected limited movement.



WARNING

Manipulator movements can cause serious injuries on users and may damage equipment.

The risk assessment should also consider other hazards arising from the application, such as, but not limited to:

- Water
- Compressed air
- Hydraulics

End-effector hazards require particular attention for applications which involve close human collaboration with the robot.

Continues on next page

1 Safety

1.5 Safety during installation and commissioning

Continued

Collaborative applications

If a robot is intended for a collaborative application, where occasional contact between the robot and the operator is expected, the safety aspects must still be addressed. See the product manual for the manipulator.

Verify the safety functions

Before the robot system is put into operation, verify that the safety functions are working as intended and that any remaining hazards identified in the risk assessment are mitigated to an acceptable level.

1.6 Safety during operation

Automatic operation

Verify the application in the operating mode manual reduced speed, before changing mode to automatic and initiating automatic operation.

Lock and change of operating mode

To prevent hazard, it is the responsibility of the integrator to make sure that keys used to lock or change the operating mode are handled only by authorized personnel.

Safety devices not in use

Safety devices that are not connected to the robot or robot system cannot initiate a protective or emergency stop. These must be stored out of sight so that they cannot be mistaken for being in use.

1 Safety

1.7 Safety during maintenance and repair

1.7 Safety during maintenance and repair

General

Corrective maintenance must only be carried out by personnel trained on the robot. Maintenance or repair must be done with all electrical, pneumatic, and hydraulic power switched off, that is, no remaining hazards.

Never use the robot as a ladder, which means, do not climb on the controller, manipulator, including motors, or other parts. There are hazards of slipping and falling. The robot might be damaged.

Make sure that there are no tools, loose screws, turnings, or other unexpected parts remaining after maintenance or repair work.

When the work is completed, verify that the safety functions are working as intended.

Hot surfaces

Surfaces can be hot after running the robot, and touching these may result in burns. Allow the surfaces to cool down before maintenance or repair.

Hazards related to batteries

Under rated conditions, the electrode materials and liquid electrolyte in the batteries are sealed and not exposed to the outside.

There is a hazard in case of abuse (mechanical, thermal, electrical) which leads to the activation of safety valves and/or the rupture of the battery container. As a result under certain circumstances, electrolyte leakage, electrode materials reaction with moisture/water or battery vent/explosion/fire may follow.

Do not short circuit, recharge, puncture, incinerate, crush, immerse, force discharge or expose to temperatures above the declared operating temperature range of the product. Risk of fire or explosion.

Operating temperatures are listed in [Operating conditions on page 40](#).

See safety instructions for the batteries in *Material/product safety data sheet - Battery pack (3HAC043118-001)*.

Related information

See also the safety information related to installation and operation.

1.8 Safety during troubleshooting

General

When troubleshooting requires work with power switched on, special considerations must be taken:

- Safety circuits might be muted or disconnected.
- Electrical parts must be considered as *live*.
- The manipulator can move unexpectedly at any time.



DANGER

Troubleshooting on the controller while powered on must be performed by personnel trained by ABB or by ABB field engineers.

A risk assessment must be done to address both robot and robot system specific hazards.

Related information

See also the safety information related to installation, operation, maintenance, and repair.

1 Safety

1.9 Safety during decommissioning

1.9 Safety during decommissioning

General

See section [Decommissioning on page 379](#).

If the robot is decommissioned for storage, take extra precaution to reset safety devices to delivery status.

2 Controller description

2.1 OmniCore C90XT

About OmniCore C90XT

The OmniCore C90XT is one of OmniCore C line compact controllers. The OmniCore C90XT controller offers a compact solution suitable for most applications with room for some additional equipment inside.

It is used to control an ABB manipulator used in industrial applications such as material handling and machine tending.

2 Controller description

2.2 Technical data for OmniCore C90XT controller

2.2 Technical data for OmniCore C90XT controller

Overview of the controller

OmniCore C90XT is intended to be used in industrial environment.



xx1900001447

	Reference to circuit diagram	OmniCore C90XT
Basic box		Baseline
Extension box		Option
Drive unit	T4	Baseline
Power unit	A1	Baseline
SMB connector	X2	Baseline
Force control connector	X3	Option
HMI connector (TPU)	X4	Baseline
Motor connector	X1	Baseline
Scalable I/O	K5.1	Baseline
Additional I/O	K5.2/K5.3	Option
IP20 DeviceNet	X17	Option
Conveyor tracker module	B1	Option
Motion Safety	A2.K3	Baseline
Connected Services Gateway (with antenna for 3G and WiFi)	K7	Baseline ⁱ

Continues on next page

2 Controller description

2.2 Technical data for OmniCore C90XT controller

Continued

	Reference to circuit diagram	OmniCore C90XT
Ethernet switch	K4	Option
Standard fan	G1	Baseline
Heat exchanger	G2	Baseline
Axis computer	K6	Baseline
Main computer	A2	Baseline
Power supply	T2	Baseline
Power supply	T5	Option
ODVA power supply	T5	Option
Fieldbus adapter slave	X18	Option
Process Connector	X81	Option
Filter		Option
Power inlet switch	Q0	Baseline
Power inlet connector	X0	Baseline
Robot signal exchange proxy	K2	Baseline

ⁱ Baseline is 3G. Wired or WiFi available as option.

Dimensions

Parameter	Value
Width	500 mm
Depth	355 mm
Height	520 mm

Extension box

Parameter	Value
Width	500 mm
Depth	355 mm
Height	295 mm

Weight

Controller	Weight
OmniCore C90XT	46 kg (not including the extension box)
Extension Box	25 kg



Note

The weight does not include any mounting kits fitted on the controller.

Continues on next page

2 Controller description

2.2 Technical data for OmniCore C90XT controller

Continued

Transportation and storage conditions

Parameter	Value
Minimum ambient temperature	-25 °C (-13 °F)
Maximum ambient temperature	+55 °C (+131 °F)
Maximum ambient temperature (less than 24 hrs)	+70 °C (+158 °F)
Vibration	Max. Grms = 4 m/s ² (X & Y axis), Grms = 12.8 m/s ² (Z axis)
Bumps	Max. 5 g = 50 m/s ² (11 ms)

After storage, the operating conditions inside the controller must be met for at least 6 hours before switching on the controller (see [Operating conditions on page 40](#)).

The robot controller shall be stored according to its IP classification (IP54), that is, indoors, in an environment that is dry and dust-free. In addition, wind, temperature fluctuations, and condensation shall be avoided.

See also *Product specification - OmniCore C line*.

Operating conditions

The table shows the allowed operating conditions for the controller.

Parameter	Value
Minimum ambient temperature	+5 °C (+41 °F)
Maximum ambient temperature	+45 °C (+113 °F)
Maximum ambient altitude	2,000 m
Vibration	Max. Grms = 2.86 m/s ² (X, Y, Z axis)
Bumps	Max. 5 g = 50 m/s ² (11 ms)



Note

The humidity conditions shall apply with the environmental conditions EN 60721-3-3, climatic class 3K3. For temperatures 0-30 °C, the relative humidity must not exceed 85%. For temperatures exceeding 30 °C, the absolute humidity must not exceed 25g/m³.

If the environmental conditions in EN 60721-3-3, climatic class 3K3, are not possible to meet at the installation site, desiccant bags can be placed inside the controller to achieve corresponding conditions. The desiccant bags must be replaced regularly to maintain approved operating conditions.

Protection classes

	Protection class
Controller cabinet, inner compartment for electronics	IP54
Extension box cabinet	IP54
FlexPendant	IP65

Continues on next page

2 Controller description

2.2 Technical data for OmniCore C90XT controller

Continued

The cabinet must be closed and sealed when no internal access is required.

If the cabinet is not properly closed and sealed (door and cable grommets), it does not comply with the protection class (IP54) and may affect the following:

- The electromagnetic compatibility (EMC) is affected
- Units inside the cabinet are exposed to dust or moisture. Especially important in cases with high heat and humidity, or much pollution.



Note

To comply with IP54, all openings to the controller cabinet must be sealed. This includes unconnected connectors which must be fitted with covers.

Airborne noise level

Data	Description	Note
Airborne noise level	The sound pressure level one meter away from each surface of the controller.	Controller in Motors On Mode: < 64 dB(A) Leq Controller in Standby Mode: < 61 dB(A) Leq

Power supply

Mains	Value
Voltage for OmniCore C90XT	220/230 VAC, 1 phase
Voltage tolerance	+10%, -15%
Frequency	50/60 Hz
Frequency tolerance	±3%
Short circuit current rating	According to rating label.



Note

The 2 phases (180-degree phase shift, with grounded neutral), also called Single-phase three-wire system in North America, can be supported by this controller.

Line fusing

There is no integrated fuse inside the OmniCore C90XT controller. Add an external fuse (time-delay) or circuit breaker (class K) according to full load current, as marked on the controller nameplate. The following table shows the recommended rating for an external fuse or circuit breaker.

Robot	Current (A)	Description
CRB 1300	220/230 VAC, 1 phase	10 A
IRB 910INV	220/230 VAC, 1 phase	10 A
IRB 920	220/230 VAC, 1 phase	10 A
IRB 930	220/230 VAC, 1 phase	10 A
IRB 1100	220/230 VAC, 1 phase	10 A

Continues on next page

2 Controller description

2.2 Technical data for OmniCore C90XT controller

Continued

Robot	Current (A)	Description
IRB 1200	220/230 VAC, 1 phase	10 A
IRB 1300	220/230 VAC, 1 phase	10 A

Residual current

An external earth fault protection (residual current device, RCD) is required based on the following data:

Robot	Residual Current in controller (mA)
CRB 1300	< 30 mA
IRB 910INV	< 30 mA
IRB 920	< 30 mA
IRB 930	< 30 mA
IRB 1100	< 30 mA
IRB 1200	< 30 mA
IRB 1300	< 30 mA



Note

The integrator is responsible to address local electrical requirements.

2.3 Safety functions and safety related data for OmniCore C90XT

Basic Safety Functions

The safety data is valid for the Basic Safety Functions for applicable ABB manipulators¹.

The OmniCore C90XT provides safety with structure *category 3* with performance level *d* according to EN ISO 13849-1. This fulfils the safety performance requirement as stated in the robot safety standard EN ISO 10218-1.

Safety function	MTTF _D [years]	DC [%]	PFH _D [1/hour]
Emergency stop initiated from the emergency stop device on the FlexPendant	127	93	4.29E-08
Emergency stop initiated from the emergency stop input (external emergency stop device is required)	142	92	4.29E-08
Protective stop initiated from the Automatic Stop/General Stop input (external protective stop device is required)	142	92	4.29E-08
Protective stop initiated from the three-position enabling device on the FlexPendant	104	94	4.29E-08
Output reflecting the emergency stop status of the robot	276	80	1.01E-07

Extended Safety Functions (including SafeMove options)

The safety data is valid for the Extended safety functions for applicable ABB manipulators².

Extended Safety Functions (including SafeMove options)	MTTF _D [years]	DC _{avg} [%]	PFH _D [1/hour]
Safe Brake Ramp	144	90	4.29E-08
Stand Still Supervision (SST)	144	90	4.29E-08
Axis Speed Supervision (ASP)	144	90	4.29E-08
Tool Speed Supervision (TSP)	144	90	4.29E-08
Axis Position Supervision (APO)	144	90	4.29E-08
Tool Position Supervision (TPO)	144	90	4.29E-08
Tool Orientation Supervision (TOR)	144	90	4.29E-08
Control Error Supervision	144	90	4.29E-08

Related information

[Safety data on page 16](#)

¹ The supported manipulators are listed in *Product specification - OmniCore C line*.

² The supported manipulators are listed in *Product specification - OmniCore C line*.

2 Controller description

2.4 The unit is sensitive to ESD

2.4 The unit is sensitive to ESD

Description

ESD (electrostatic discharge) is the transfer of electrical static charge between two bodies at different potentials, either through direct contact or through an induced electrical field. When handling parts or their containers, personnel not grounded may potentially transfer high static charges. This discharge may destroy sensitive electronics.

Safe handling

Use one of the following alternatives:

- Use a wrist strap. The wrist strap button is located inside the controller.
Wrist straps must be tested frequently to ensure that they are not damaged and are operating correctly.
- Use an ESD protective floor mat.
The mat must be grounded through a current-limiting resistor.
- Use a dissipative table mat.
The mat should provide a controlled discharge of static voltages and must be grounded.

Continues on next page

Wrist strap button

The location of the wrist strap button is shown in the following illustration.

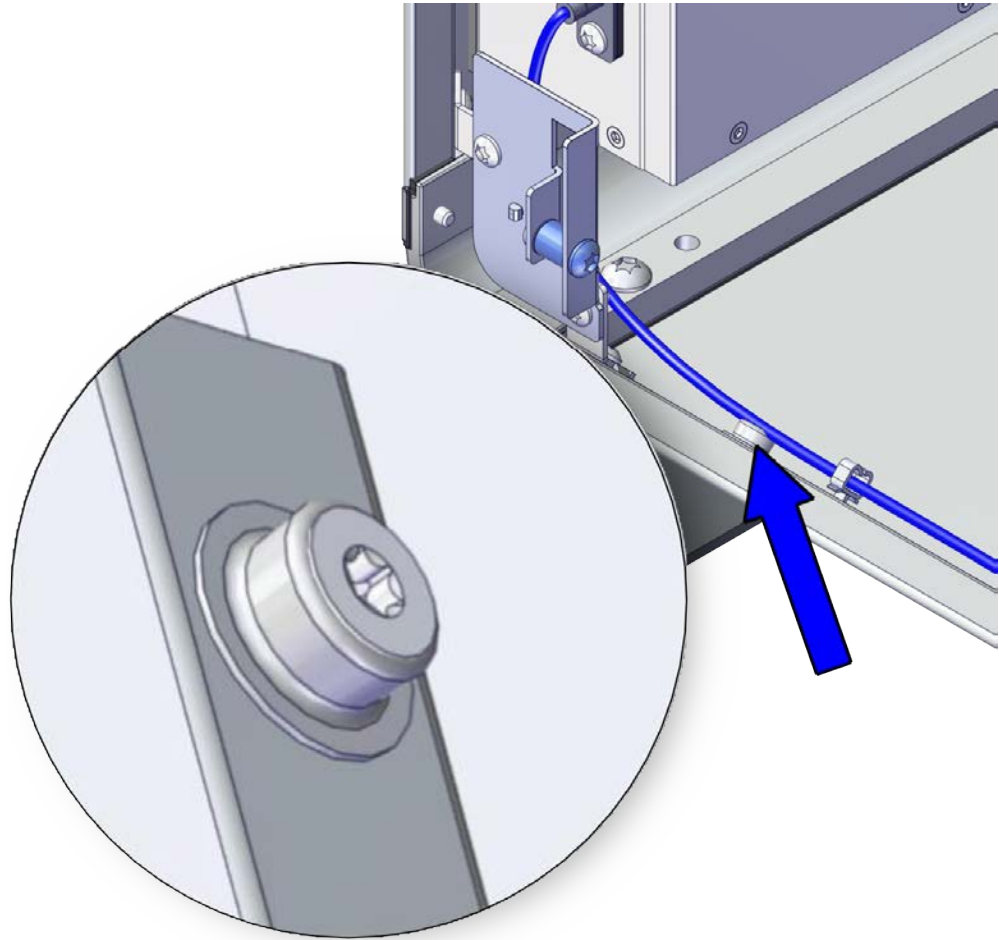

xx1900001446

There is an additional wrist strap button on the main computer.

2 Controller description

2.5 Handling of FlexPendant

2.5 Handling of FlexPendant

Detached FlexPendant

A FlexPendant that is not connected to the robot must be stored out of sight so that it cannot be mistaken for being in use.

Handling and cleaning

- The FlexPendant may only be used for the purposes mentioned in this manual.
- Always use the hand-strap while holding the FlexPendant.
- Handle with care. Do not drop, throw, or give the FlexPendant strong shock. It can cause breakage or failure.
- If the FlexPendant is subjected to shock, always verify that the safety functions (three-position enabling device and emergency stop) work and are not damaged.
- Always use and store the FlexPendant in such a way that the cable does not become a tripping hazard.
- When not using the device, place it in its holder.
- Never use sharp objects (such as screwdriver or pen) for operating the touch screen. This could damage the touch screen. Instead use your finger or a stylus.
- Never clean the FlexPendant with solvents, scouring agent, or scrubbing sponges.
See the product manual for the robot controller, section *Cleaning the FlexPendant*.
- Always close the protective cap on the USB port when no USB device is connected. The port can break or malfunction if exposed to dirt or dust.
- Do not squeeze and thus damage the cable.
- Do not lay the cable over sharp edges.



CAUTION

The FlexPendant touch screen is made of glass. If the device is dropped on a hard surface or receives a significant impact the glass could break. To reduce the risk of cuts if the glass chips or cracks, do not touch or attempt to remove the broken glass.

FCC statement

Changes or modification to the FlexPendant not expressly approved by ABB will void the user's authority to operate the equipment.

This device complies with Part 15 of the FCC Rules. Operation is subject to the following two conditions:

- 1 This device may not cause harmful interference, and
- 2 This device must accept any interference received, including interference that may cause undesired operation.

2.6 Network security

Network security

This product is designed to be connected to and to communicate information and data via a network interface. It is your sole responsibility to provide, and continuously ensure, a secure connection between the product and to your network or any other network (as the case may be).

You shall establish and maintain any appropriate measures (such as, but not limited to, the installation of firewalls, application of authentication measures, encryption of data, installation of anti-virus programs, etc) to protect the product, the network, its system and the interface against any kind of security breaches, unauthorized access, interference, intrusion, leakage and/or theft of data or information. ABB Ltd and its entities are not liable for damage and/or loss related to such security breaches, any unauthorized access, interference, intrusion, leakage and/or theft of data or information.

2 Controller description

2.7 Open source and 3rd party components

2.7 Open source and 3rd party components

Open source and 3rd party components

ABB products use software provided by third parties, including open source software. The following copyright statements and licenses apply to various components that are distributed inside the ABB software. Each ABB product does not necessarily use all of the listed third party software components. Licensee must fully agree and comply with these license terms or the user is not entitled to use the product. Start using the ABB software means accepting also referred license terms. The third party license terms apply only to the respective software to which the license pertains, and the third party license terms do not apply to ABB products. With regard to programs provided under the GNU general public license and the GNU lesser general public license licensor will provide licensee on demand, a machine-readable copy of the corresponding source code. This offer is valid for a period of three years after delivery of the product.

ABB software is licensed under the ABB end user license agreement, which is provided separately.

RobotWare

For RobotWare, there is license information in the folder \licenses in the RobotWare distribution package.

OpenSSL

This product includes software developed by the OpenSSL Project for use in the OpenSSL Toolkit. (<http://www.openssl.org/>)

This product includes cryptographic software written by Eric Young (ey@cryptsoft.com).

This product includes software written by Tim Hudson (tjh@cryptsoft.com).

CTM

For OleOS, the Linux based operating system used on the conveyor tracking module (CTM), a list of copyright statements and licenses is available in the file `/etc/licenses.txt` located on the CTM board and accessible via the console port or by downloading the file over SFTP.

For the CTM application, a list of copyright statements and licenses is available in the file `/opt/ABB.com/ctm/licenses.txt` located on the CTM board and accessible via the console port or by downloading the file over SFTP.

2.8 ABB Connected Services (ABB Ability)



Note

The content of this section is only available in English.



Note

ABB Connected Services is the new name for the functionality previously known as ABB Ability. During a period of time, both names will appear in and on our products.

The OmniCore™ controller hardware is delivered with a standard mobile connection (Cellular data connection), or WIFI modem and/or Ethernet connection.

Cellular data connection

If the ABB Connected Services™ OmniCore™ controller hardware is delivered together with a standard, free of charge (machine-to-machine or M2M) cellular data connection, it will automatically establish a connection to the ABB Connected Services™ digital platform once the power switch of the ABB Connected Services™ OmniCore™ controller hardware has been turned on and has been connected. After the establishment of the connection there will be a data flow from the OmniCore™ controller hardware to the ABB Connected Services™ digital platform.

ABB does not warrant or guarantee an available, stable, uninterrupted, and interference free connection through the standard cellular data connection. This is dependent on the availability and quality of the cellular data signal as provided by the telecommunications carrier on the location where the ABB Connected Services™ OmniCore™ hardware is installed. The cellular data connection is to be used solely in connection with the ABB Connected Services™ OmniCore™ controller hardware and excludes, without limitation, voice services, web browsing, music downloading and other services that are not traditionally considered as machine to machine (M2M), but human-oriented telecommunication services.

ABB has established and maintains a formal information and cybersecurity procedures which includes commercially reasonable technical and organizational measures, in order to protect the data against security breaches, accidental or unlawful destruction, loss, alteration, and unauthorized disclosure of, or access to the data.

The cellular data connection is not required for the operation of the hardware and the connectivity settings can be adjusted and turned off at any given time. Detailed information on the mobile connection is further described in the service description that can be downloaded from the following web location:

<https://share.library.abb.com/api/v4?cid=9AAC910011&dk=Manual>

Continues on next page

2 Controller description

2.8 ABB Connected Services (ABB Ability)

Continued

FCC statement



Note

This equipment has been tested and found to comply with the limits for a Class A digital device, pursuant to part 15 of the FCC Rules.

These limits are designed to provide reasonable protection against harmful interference when the equipment is operated in a commercial environment.

This equipment generates, uses, and can radiate radio frequency energy and, if not installed and used in accordance with the instruction manual, may cause harmful interference to radio communications.

Operation of this equipment in a residential area is likely to cause harmful interference in which case the user will be required to correct the interference at his own expense.

Operation is subject to the following conditions:

(1) This device may not cause harmful interference, and (2) this device must accept any interference received, including interference that may cause undesired operation.

Changes or modifications not expressly approved by ABB could void the user's authority to operate the equipment under FCC rules. When the optional connectivity module is installed, the operating conditions must be such that there is a minimum separation distance of 20 cm between the dedicated antenna and nearby persons or other antennas. An intentional radiator may be operated only with the antenna which it is authorized for and accepted by ABB.

The product may be equipped with a connectivity module for 3G or for Wi-Fi as an option.

- The 3G option contains FCC ID: XMR201510UC20 by courtesy of Quectel
- The Wi-Fi option contains FCC ID: Z64-WL18SBMOD by courtesy of Texas Instruments

ABB legal contacts for FCC:

John Bubnikovich, ABB Robotics, 1250 Brown Road, Auburn Hills, MI 48326 USA,
john.bubnikovich1@us.abb.com

Ed Marchese, ABB Robotics, 1250 Brown Road, Auburn Hills, MI 48326 USA,
ed.marchese@us.abb.com

Continues on next page

Data

ABB will not acquire any right, title and interest in the data other than the rights granted by Customer to ABB, but ABB will have the right to collect, store, aggregate, analyze or otherwise use the data for (i) providing and maintaining the hardware, services and/or the ABB software to Customer; (ii) preventing, detecting and repairing problems related to the security and/or the operation of the hardware, the platform, software; (iii) improving and developing existing services, technologies, products and/or software and developing new services, technologies, products and/or software, and all improvements and developments (including all resulting intellectual property Rights) are exclusively owned by us. In addition, we have the right to use the data for benchmarking purposes if and to the extent it is anonymized or non-confidential.

ABB Connected Services™

For as far as the robot installation includes ABB Connected Services™, this agreement is entered pursuant to and governed by the ABB Connected Services™ General Terms and Conditions.

ABB Connected Services™ Terms and Conditions:

<https://ability.abb.com/terms>

Special Terms and Conditions for ABB Connected Services™:

<https://new.abb.com/products/robotics/service/robot-registration>

This page is intentionally left blank

3 Installation and commissioning

3.1 Introduction to installation and commissioning

General

This chapter contains assembly instructions and information for installing the OmniCore C90XT at the working site.

See also the product manual for the manipulator.

The installation must be done by qualified installation personnel in accordance with the safety requirements set forth in the applicable national and regional standards and regulations.

The technical data is detailed in section [Technical data for OmniCore C90XT controller on page 38](#).

Safety information

Before any installation work is commenced, all safety information must be observed. There are general safety aspects that must be read through, as well as more specific safety information that describes the danger and safety risks when performing the procedures. Read the chapter [Safety on page 15](#) before performing any installation work.



Note

Always connect the OmniCore C90XT and the robot to protective earth and residual current device (RCD) before connecting to power and starting any installation work.

3 Installation and commissioning

3.2 Installation activities

3.2 Installation activities

Main steps for installing the controller

Use the following main steps to install and connect the controller.

	Action	Described in
1	Unpack the controller.	Unpacking the controller on page 56.
2	Place the controller in position and bolt it to the ground.	On-site installation on page 58.
3	Connect the manipulator to the controller.	Connecting the manipulator to the controller on page 79.
4	Attach the FlexPendant to the controller.	Attaching the FlexPendant on page 89
5	Install an external circuit breaker or fuse.	Connecting incoming mains and protective earth to the controller on page 83
6	Connect the cabinet to protective earth.	Connecting incoming mains and protective earth to the controller on page 83
7	Install a residual current device (RCD).	Connecting incoming mains and protective earth to the controller on page 83
8	Connect incoming mains to the controller.	Connecting incoming mains and protective earth to the controller on page 83
9	Connect safeguards to the controller.	Connector X14 on page 92.
10	Connect, for example, Ethernet, PC, and other connections.	How to connect industrial networks, for example PROFINET, is described in the respective application manual. How to connect to a network and a PC is described in section Ethernet networks on OmniCore on page 90 . See also <i>Operating manual - RobotStudio</i> . See also Descriptions for connectors on page 92 .
11	Connect the antenna for Connected Services.	Connecting the Connected Services antenna on page 69.
12	Install options and add-ons (optional).	Installing options on page 116. Installing add-on devices on page 156.
13	Initial test before commissioning.	Initial test before commissioning on page 165.



Note

If the controller replaces another OmniCore controller, see *Operating manual - Integrator's guide OmniCore* for descriptions of how to transfer software configurations.

3.3 Transporting and handling

3.3.1 Lifting the controller cabinet

Lifting device

Use the four lifting eyes (Torque: 11.3 Nm-12.6 Nm) or a forklift when lifting the controller, as shown below.

The following figure shows the maximum angle between the lifting straps when lifting the controller. The weight of the controller module is detailed in section [Weight on page 39](#).

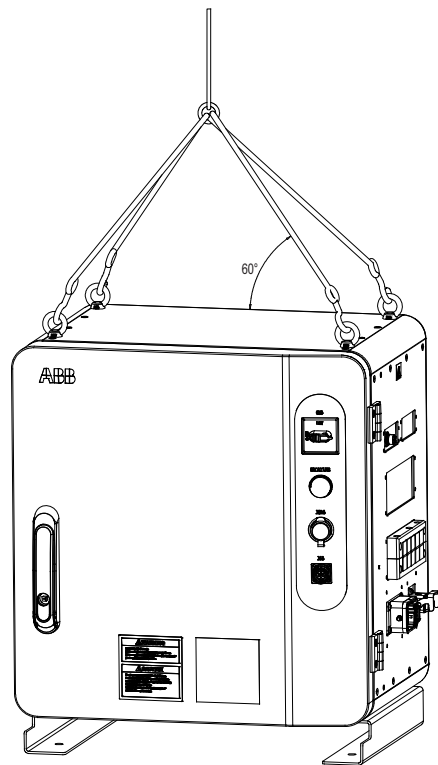

xx1900001445



Note

After removing the lifting lock, tighten the plastic screws (Torque: 0.8 Nm-1 Nm) for the controller cabinet.

3 Installation and commissioning

3.3.2 Unpacking

3.3.2 Unpacking

Unpacking the controller

	Action
1	Make a visual inspection of the packaging and make sure that nothing is damaged.
2	Remove the packaging.
3	Check for any visible transport damage.  Note Stop unpacking and contact ABB if transport damage is found.
4	Clean the unit with a lint-free cloth, if necessary.
5	Make sure that the lifting accessory used (if applicable) is suitable to handle the weight of the controller.
6	If the controller is not installed directly, it must be stored as described in Transportation and storage conditions on page 40 .
7	Make sure that the expected operating environment of the controller conforms to the specifications as described in Operating conditions on page 40 .
8	The controller can be taken to its installation site as described in section On-site installation on page 58 .

3.3.3 Storing

Storing the controller

For storing, see [Transportation and storage conditions on page 40](#).

3 Installation and commissioning

3.4.1 Required installation space

3.4 On-site installation

3.4.1 Required installation space

Dimensions

The following illustration shows the required installation space for the OmniCore C90XT controller.

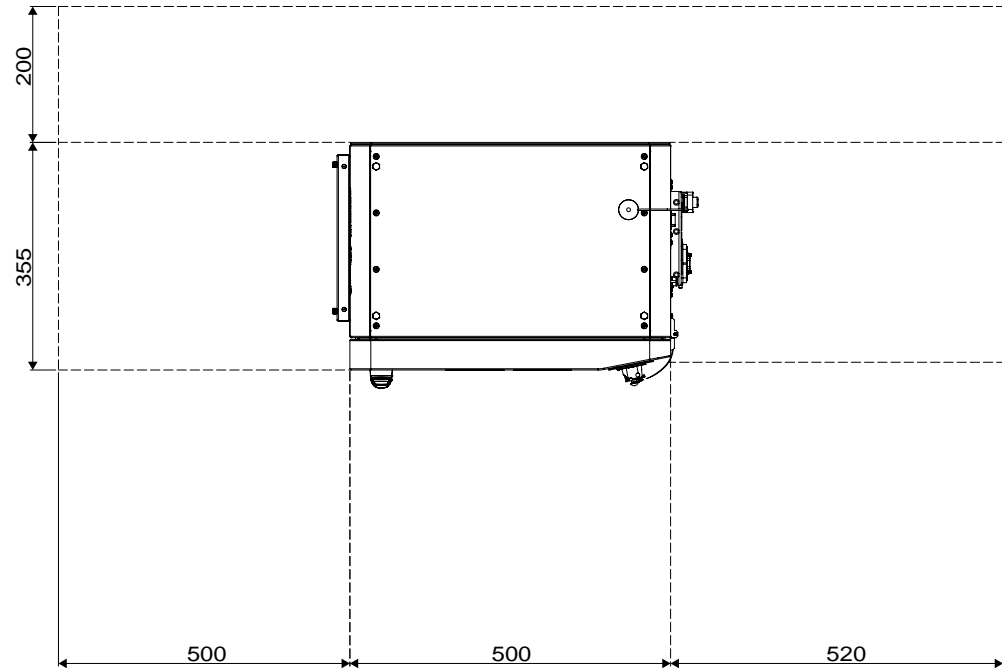

xx1900001448

- A free space of 500 mm on the front of the controller is required if the controller is mounted on a desk (not rack-mounted).
- A free space of 200 mm on the back of the controller is required if the controller is mounted on a desk (not rack-mounted).
- A free space of 500 mm on the left side of the controller is required if the controller is mounted on a desk (not rack-mounted). Do not place any cables over the left cover as it leads to inefficient cooling.
- A free space of 520 mm on the right sides of the controller is required if the controller is mounted on a desk (not rack-mounted). Do not place any cables over the right covers as it leads to inefficient cooling.

Continues on next page

3 Installation and commissioning

3.4.1 Required installation space

Continued

The following illustration shows the dimensions between the feet of the OmniCore C90XT controller, as seen from below.

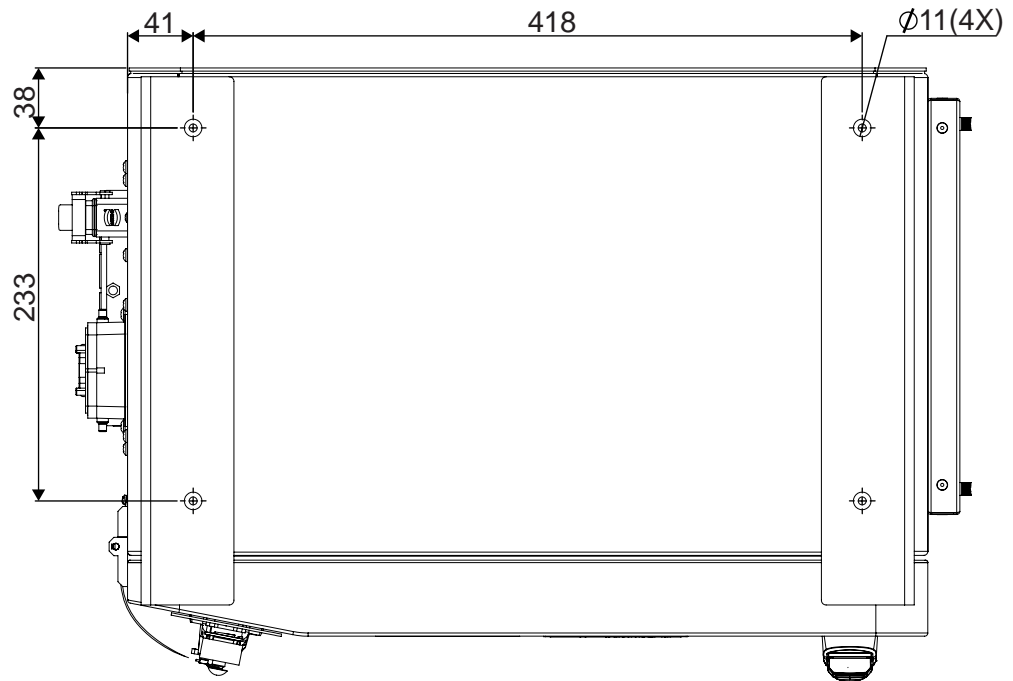

xx1900001449

The feet will be used for positioning and fastening.

Mounting requirements:

- Anchor bolts: M8 X 4
- Tightening torque: 11.3 Nm-12.6 Nm
- Maximum flatness deviation of the installation plane: 8 mm



Note

Fix the controller to a concrete foundation or steel platform with anchor bolts during stacking.



Note

According to IEC60204-1, the power-operated switch should be installed between 600 mm to 1,900 mm above the servicing level. The switch will be easily accessible.

3 Installation and commissioning

3.4.2 Securing and stacking the controller cabinet

3.4.2 Securing and stacking the controller cabinet

Securing the controller

The controller can be secured to the ground. The figure below shows the bolt pattern for the OmniCore C90XT controller. The diameter of the four bolt holes are 14 mm.

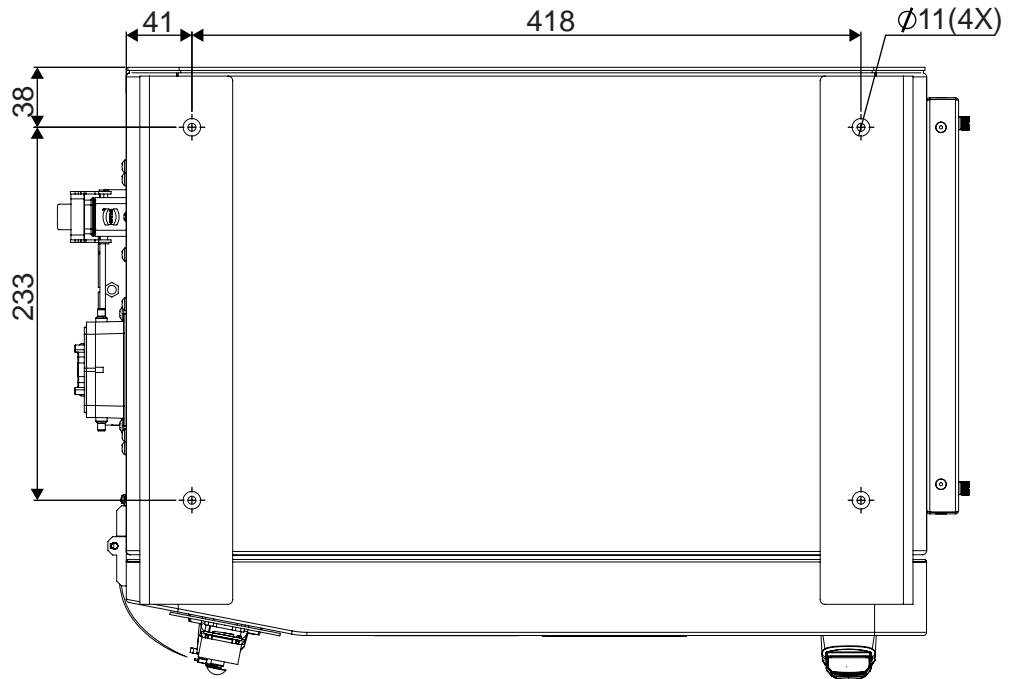

xx1900001449

Stacking the controller

The OmniCore C90XT controller is designed so that a maximum of three controllers can be stacked on top of each other. The controllers must be safely fixed to each other, and it must be assured that the opened door on the upper controller does not cause imbalance.



CAUTION

The stacked cabinets must not tilt more than 10 degrees.



Note

For lifting restrictions regarding stacked cabinets, see [Lifting the controller cabinet on page 55](#).

Continues on next page

3 Installation and commissioning

3.4.2 Securing and stacking the controller cabinet

Continued

Procedure

Use this procedure to stack the a controller onto another controller.

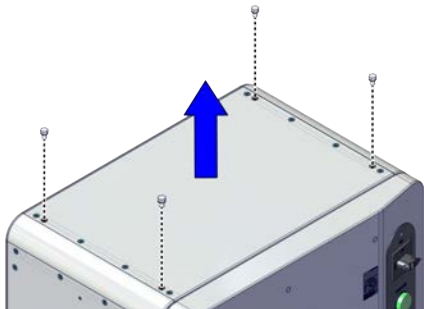
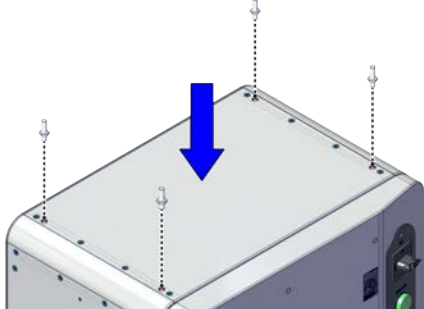
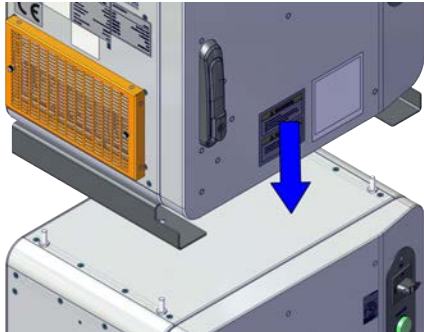
	Action	Info/illustration
1	Remove the four screws on top of the controller.	 <p>xx2200002032</p>
2	Install the mounting bolts.	 <p>xx2200002033</p>
3	Place the upper controller with locating on the bolts.	 <p>xx2200002034</p>

Continues on next page

3 Installation and commissioning

3.4.2 Securing and stacking the controller cabinet

Continued

	Action	Info/illustration
4	Tighten and lock the controllers with the bolts and nuts.	 <p data-bbox="959 719 1066 741">xx2200002035</p> <p data-bbox="959 757 1321 790">Tightening torque: 5.5 Nm±10%.</p>

3.4.3 Mounting the FlexPendant holder



Note

To avoid dropping the FlexPendant from height, the holder should be placed in a comfortable working height.

Always use and store the FlexPendant in such a way that the cable does not become a tripping hazard.

When not using the device, place it so it does not accidentally fall.

Required equipment

Equipment	Spare part number	Note
Standard toolkit		See Standard toolkit for controller on page 448 .
FlexPendant Holder w/t E-stop cover	3HAC064927-001	



Note

The FlexPendant should always be placed in the holder when it is not used and it is not allowed to use by unauthorized person.

Continues on next page

3 Installation and commissioning

3.4.3 Mounting the FlexPendant holder

Continued

Mounting the bracket for the emergency stop on the FlexPendant holder

The FlexPendant holder is shipped without the bracket for the emergency stop assembled to the holder. They are separated as two parts.

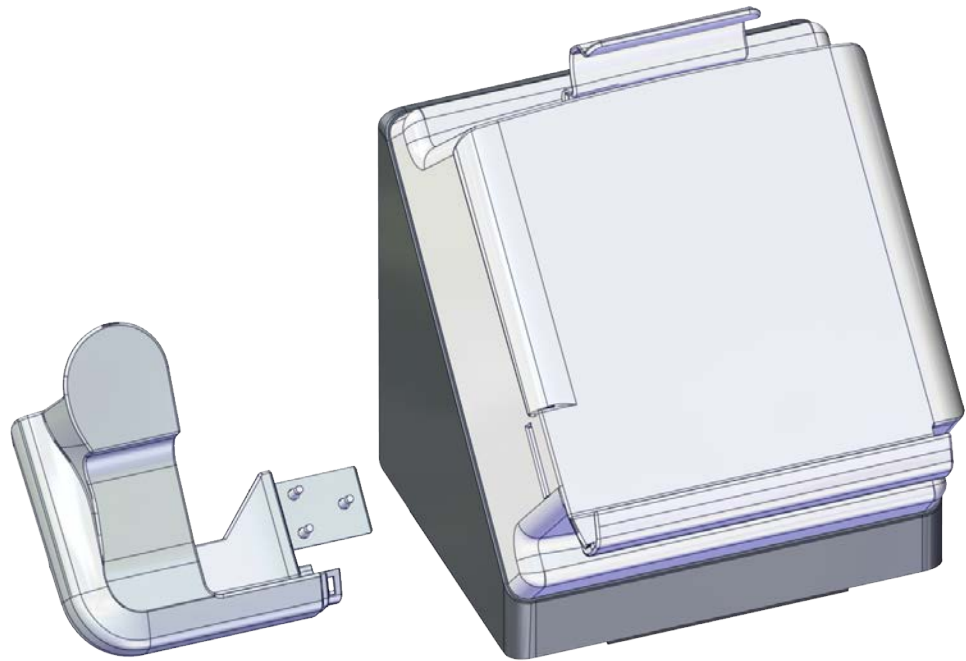

xx2100000767

Use this procedure to mount the bracket for the emergency stop to the FlexPendant holder.



	Action	Note/illustration
1	Remove the four screws.	 <p data-bbox="927 1809 1031 1827">xx2000002356</p>
2	Separate the rear part from the FlexPendant holder.	

Continues on next page

3 Installation and commissioning

3.4.3 Mounting the FlexPendant holder

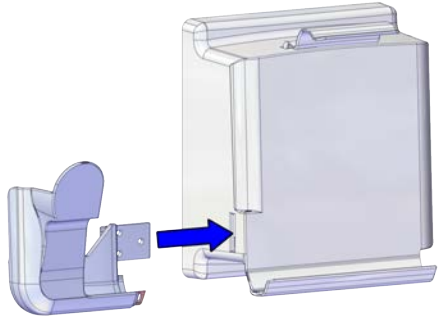
Continued

	Action	Note/illustration
3	Insert the bracket into the FlexPendant holder.	 <p>xx2100000765</p>
4	Secure with the screws.	<p>Screws: BN33 Phillips pan head tapping screw ST2.9x13 (3 pcs) Tightening torque: 6 Nm-7.8 Nm</p>  <p>xx2100000766</p>
5	Refit the rear part and secure with the screws.	<p>Screws: BN33 Phillips pan head tapping screw ST3.5x16 (4 pcs) Tightening torque: 9.4 Nm-12.2 Nm</p>  <p>xx2000002356</p>

Continues on next page

3 Installation and commissioning

3.4.3 Mounting the FlexPendant holder

Continued

Mounting the FlexPendant holder onto a flat surface (Horizontally)

Use this procedure to mount the FlexPendant holder onto a flat surface, like the top of the controller or a desktop.

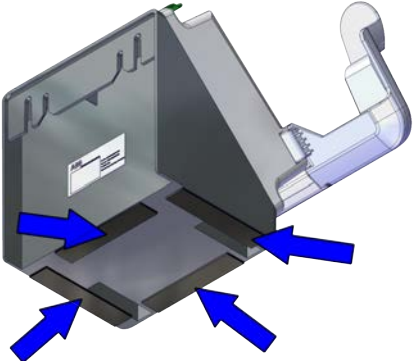
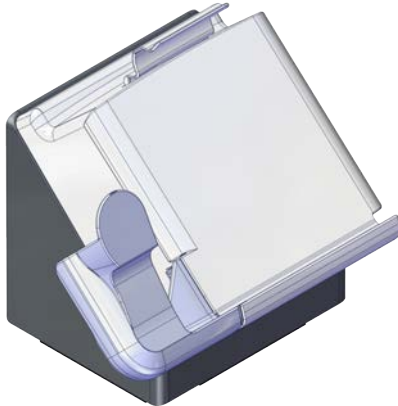
	Action	Note/illustration
1	Clean the surface and make sure it is dry.	
2	Remove the protective liner from the tape.	 xx2000002352
3	Press the holder onto the desired place.	 xx2000002353

Hanging the FlexPendant holder with the bracket

Use this procedure to hang the FlexPendant holder on any place that can hold the bracket, like the door of the equipment.



Tip

The bracket is included on delivery.

Continues on next page

3 Installation and commissioning

3.4.3 Mounting the FlexPendant holder

Continued

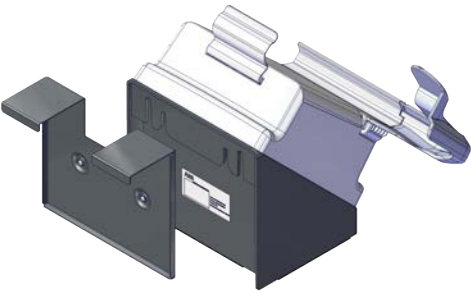
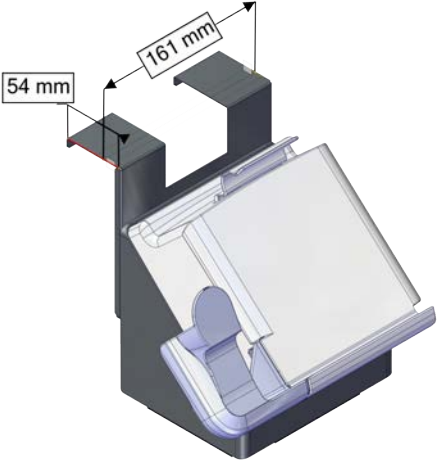
	Action	Note/illustration
1	Hang the FlexPendant holder to the bracket according to the screws on the bracket.	 <p data-bbox="954 674 1062 689">xx2000002354</p>
2	Hang the holder with the bracket to the desired place.	 <p data-bbox="954 1200 1062 1216">xx2000002355</p>

Hanging the front part of the FlexPendant holder with screws (Vertically)

Use this procedure to hang the front part of the FlexPendant holder to the desired place.



	Action	Note/illustration
1	Remove the four screws.	 <p data-bbox="954 1928 1062 1944">xx2000002356</p>
2	Separate the rear part from the FlexPendant holder.	
3	Clean the surface and make sure it is dry.	

Continues on next page

3 Installation and commissioning

3.4.3 Mounting the FlexPendant holder

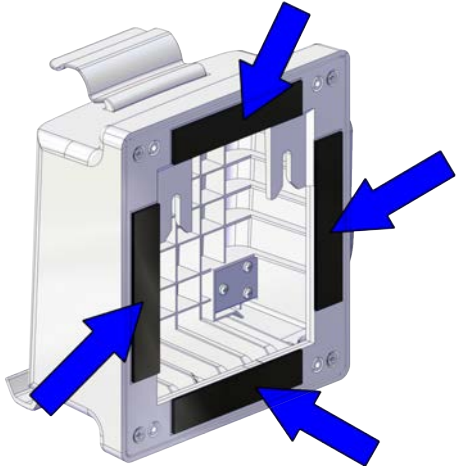
Continued

	Action	Note/illustration
4	Remove the protective liner from the tape.	 <p>xx2000002357</p>
5	Press the holder onto the desired place.	
6	Use two M5 screws to secure the holder.	 <p>78 mm</p> <p>xx2000002358</p>

3.4.4 Connecting the Connected Services antenna

Connect the Connected Services antenna

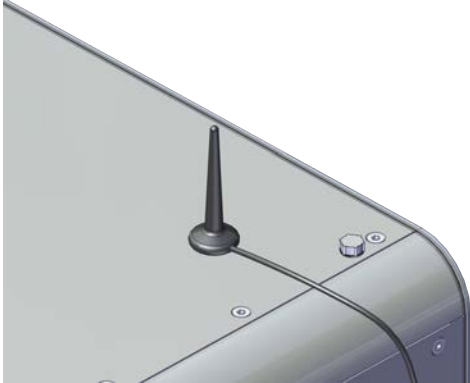
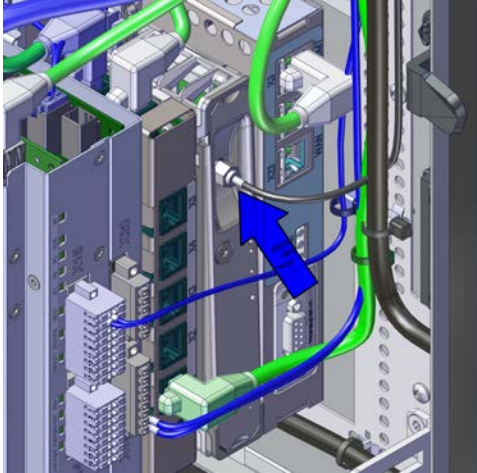
	Action	Note/Illustration
1	Place the magnet part of the antenna on the outside of the cabinet.	 <p>xx1900001949</p> <p>Note</p> <p>The operating conditions must be such that there is a minimum separation distance of 20 cm between the dedicated antenna and nearby persons.</p>
2	Insert the antenna cable through the cable grommet.	<i>Removing the cable grommet assembly on page 341.</i>
3	Apply cable ties and suitable cable protection to ensure that the cable may not be damaged by the door.	
4	Connect the antenna cable to the Connected Services gateway by rotating the connector.	 <p>xx1900001948</p>

3 Installation and commissioning

3.5.1 Connectors on the OmniCore C90XT controller

3.5 Electrical connections

3.5.1 Connectors on the OmniCore C90XT controller

General

The following section describes the connectors on the covers of the OmniCore C90XT controller.



CAUTION

Always inspect the connector for dirt or damage before connecting it to the controller. Clean or replace any damaged parts.

Connectors

The following details the connection interface on the OmniCore C90XT controller.

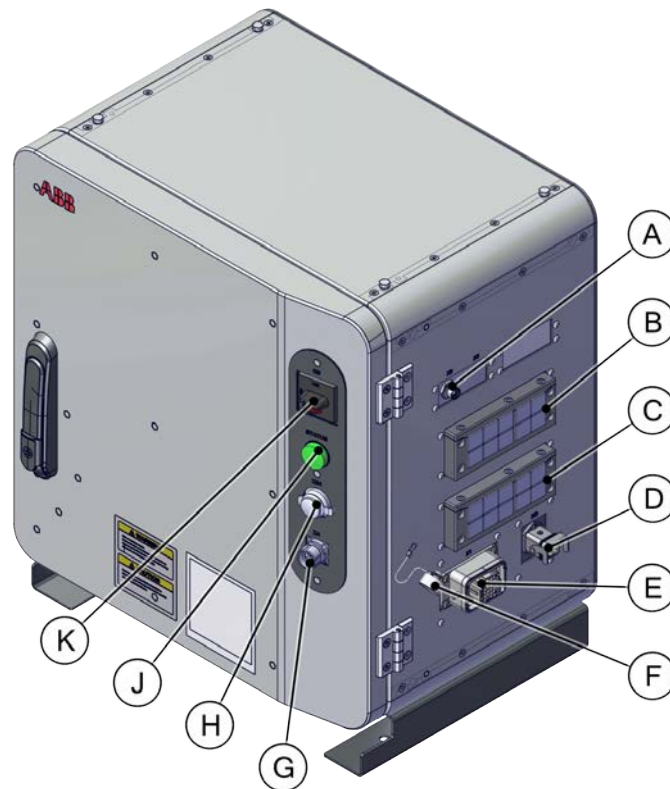

xx2000000338

	Description
A	Manipulator signal connector
B	Cable grommet assembly (option)
C	Cable grommet assembly
D	Power inlet connector
E	Motor connector

Continues on next page

3 Installation and commissioning

3.5.1 Connectors on the OmniCore C90XT controller

Continued

	Description
F	TPU cover
G	FlexPendant connection (TPU connector)
H	ETH outlet connector
J	Motors on lamp
K	Power inlet switch

3 Installation and commissioning

3.5.2 Connecting cables to the controller

3.5.2 Connecting cables to the controller

General

A good and proper electrical installation of the robot system is necessary to ensure the best performance and prolong the lifetime of the whole robot system.

This section includes important information on how to connect cables and signals to the controller.

Signal classes

Different rules apply to the different classes when selecting and laying cables. Signals from different classes must not be mixed.

Signal class	Description
Power signals Class 4 (noisy)	Supplies external motors and brakes. Applies to the cables associated with the power inputs and outputs of variable speed drives. Cables carrying strongly interfering signals such as motor cables, DC-link load sharing, unsuppressed inductive loads, DC motors, welding equipment, etc.
Control signals Class 3 (slightly noisy)	Digital operating and data signals (digital I/O, protective stop, etc.). Applies to cables carrying slightly interfering signals: AC power supply (<1 kV), DC power (24 V), power to equipment with RFI/EMI filters, control circuits with resistive or suppressed inductive loads (such as contactors and solenoids), direct-on-line induction motors, etc.
Measurement signals Class 2 (slightly sensitive)	Analog measurement and control signals (resolver and analog I/O). This class covers ordinary analogue signals such as analogue signals (4-20 mA, 0-10V, or signals below 1 MHz), low-speed digital signals (RS232, RS485), digital (on/off) signals, limit switches, encoders, etc.
Data communication signals Class 1 (sensitive)	Gateway (fieldbus) connection, computer link. Applies to cables carrying very sensitive signals. Signals with a full-scale range less than 1 V or 1 mA, and/or a source impedance >1 kOhm, and/or a signal frequency >1 Mhz. For example high-speed digital communication (Ethernet), thermocouples, thermistors, strain gauges and flowmeters.

Selecting cables

All cables laid in the control cabinet must be capable of withstanding 70 °C. In addition, the following rules apply to the cables of certain signal classes:

Signal class	Cable type
Power signals	Shielded cable with an area of at least 0.75 mm ² or AWG 18.
Control signals	Shielded cable.
Measurement signals	Shielded cable with twisted pair conductors.
Data communication signals	Shielded cable with twisted pair conductors. A specific cable should be used for field bus connections and Ethernet, according to the standard specification of the respective bus.

Continues on next page



Note

Any local standards and regulations concerning insulation and area must always be complied with.

AC current in CP/CS

For specific applications where the correct cable dimensioning can depend on the relationship between the period of the duty cycle and the thermal time constant of the cable (for example, starting against high-inertia load, intermittent duty), the cable manufacturer can provide information.

Country specific norms have to be included.

The wire is not dimensioned to take care of starting motors or transformers.

The following table shows how much AC current can be supplied with a specific temperature, and the wire size.

Wire size (mm ² //AWG)	AC current			
	40°C//104F	45°C//113F	50°C//122F	52°C//125.6F
Single wire 0.2//24	4.5	4.1	3.7	3.2
Multi wire 2 pair 0.2//24	3.6	3.3	3.0	2.6
Multi wire 4 pair 0.2//24	2.9	2.7	2.4	2.1
Multi wire 6 pair 0.2//24	2.6	2.3	2.1	1.8
Multi wire 9 pair 0.2//24	2.3	2.0	1.8	1.6
Single wire 0.5//20	7.9	7.2	6.5	5.6
Multi wire 2 pair 0.5//20	6.3	5.8	5.2	4.5
Multi wire 4 pair 0.5//20	5.1	4.7	4.2	3.6
Multi wire 6 pair 0.5//20	4.5	4.1	3.7	3.2
Multi wire 9 pair 0.5//20	4.0	3.6	3.2	2.8
Single wire 0.75//18	9.5	8.6	7.8	6.7
Multi wire 2 pair 0.75//18	7.6	6.9	6.2	5.4
Multi wire 4 pair 0.75//18	6.2	5.6	5.1	4.4
Multi wire 6 pair 0.75//18	5.4	4.9	4.4	3.8
Multi wire 9 pair 0.75//18	4.8	4.3	3.9	3.4
Single wire 1.0//17	11.0	10.0	9.0	7.8
Multi wire 2 pair 1.0//17	8.8	8.0	7.2	6.2
Multi wire 4 pair 1.0//17	7.2	6.5	5.9	5.1
Multi wire 6 pair 1.0//17	6.3	5.7	5.1	4.5
Multi wire 9 pair 1.0//17	5.5	5.0	4.5	3.9
0.75//18 three phase	8.6	7.8	7.1	5.6
1.0//17 three phase	10.3	9.4	8.4	6.7

Continues on next page

3 Installation and commissioning

3.5.2 Connecting cables to the controller

Continued

Route the cables

Routing of cables shall be done in a professional way.

- Cables of different classes, such as signal cables and power cables, must not be routed together as the power cables may introduce noise in the signal cables. The greater the separation distance, the lesser the risk for interference between the cables.
- Robot controller mains supply input cable and robot power cable should be separated even though they belong to the same class.
- If crossing cables from different classes, cables should cross at an angle close to 90 degrees.
- All external cables that are to be connected inside the controller must be shielded in the chassis before entering the cabinet.

Separation distances can be reduced if e.g. dividers are used between cables classes. Manufacturers of cable duct systems can provide information on how reduced separation distances can be achieved using their specific products.

Signal class	Cable type
Power signals	<ul style="list-style-type: none">• These signals generate a lot of interference and must be laid separate from control, measurement, and communication signals.• The shielding must be connected to a paint-free part of the panel chassis of the cabinet at both ends of the cable. Any unshielded cable must be as short as possible.• The manipulator power cables are routed on the floor and along the left side of the controller cabinet.• Cables should not be wound up like coils. This could cause an magnetic field disturbing the signals. There will also be a risk of overheating depending on the load.
Control signals	<ul style="list-style-type: none">• These signals are very sensitive to interference. To protect these signals they should not be laid along with the power signals.
Measurement signals	
Data communication signals	

Shielding cables

When peripheral devices are connected to the robot system, a shielded cable is necessary to reduce coupling of the inner cable conductors to the environment they pass through.

Shielding cable requirements

- The best method for shielding is to ground the shield at both ends of the cable, provided the ends grounding are at the same potential.
- If the grounding points have different electric potentials - grounding both ends will create a ground loop allowing unwanted current to flow in the shield. In such cases one end grounding may be used. The grounding point should then be at the robot controller side.
- Cables carrying analog low-level signals is another exception where the shield should be grounded at only one end.

Continues on next page

- Most data network and field bus types have defined grounding topologies. If such grounding schemes exist, they should be followed.
- In complex interference environments, two-layer shielding may be required. The inner shield should be grounded at the controller side only end and the outer shield should be grounded at both ends. The optimum shielding is a combination of foil and braid screens.
- The best connection is one in which the shielding is extended up to and makes a solid 360° connection (shown below) with the ground plane or chassis.

Shielding example

The below example shows the shielding of a d-type connector:

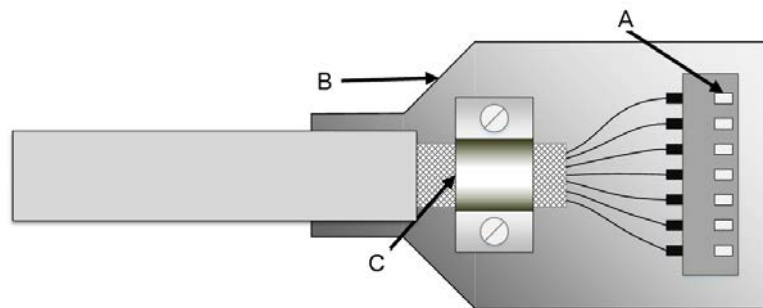

xx1700001320

- A A dimpled connector body makes multiple bonds to the mating connector body all around its periphery, 360° bonding.
- B Metal, or metallized, back shell makes 360° bond to the connector body.
- C The cable shield is exposed and 360° clamped to the back shell. A tight fit is a must.

Many other 360° bonding methods and types of 360° shielded connectors are also acceptable.

Shield pigtail termination

Shield pigtail termination, as shown below, shall be avoided. If a pigtail connection cannot be avoided, make it as short as possible.

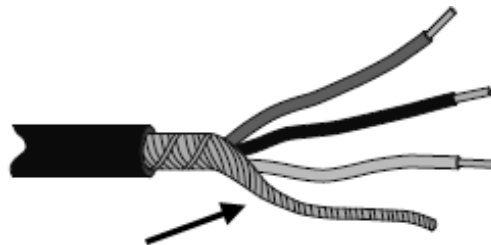

xx1700001321

Continues on next page

3 Installation and commissioning

3.5.2 Connecting cables to the controller

Continued

Ground and screen connections

The task of the grounding system is twofold - protective and functional. The primary task is to serve as protective earth (PE) for personal and equipment safety. The secondary task is to serve as a return path for common mode current.

For further information refer to EN 60204-1 and UL 1740.

Grounding requirements

The controller cabinet ground must come from the mains power supply PE.

- The grounding cable color shall be green-yellow.
- The ground for the controller cabinet, robot manipulator and peripheral devices must be the same, preferably an equipotential ground grid (mesh).
- Ground connection points must have stable inter-metallic bonding, like screw fixation. Paint, dirt, rust, and other insulating material must be removed from the contacting surfaces.

For requirements on the marking of the supply ground connection inside the control cabinet refer to UL 508C. For further details on how grounding systems should be designed refer to IEC 61000-5-2. For details of cross-sectional area of PE refer to IEC 60204-1.

Grounding installation

For information on how to connect protective earth to the OmniCore controller cabinet, see [Connecting incoming mains and protective earth to the controller on page 83](#).

For information on how to connect protective earth for the manipulator, see the corresponding product manual.

Continues on next page

Examples

The following figure shows 2 examples on how protective earth and the signal cable screens can be connected:

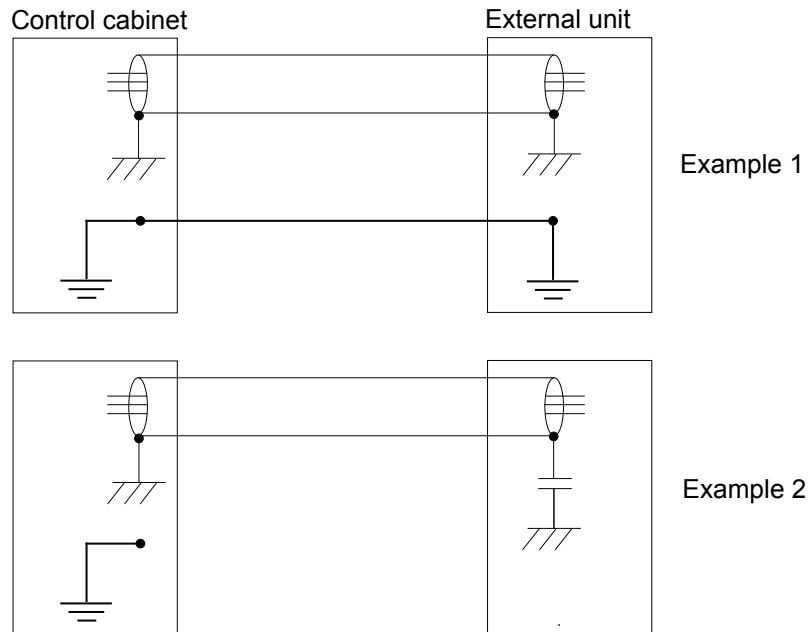

xx120000960

Example 1:

- Where a good earth connection is available on all units, the best shielding is obtained by grounding all screens at both ends on all units.

Example 2:

- If the cable is terminated where a good earth connection is not available a noise suppression capacitor can be used. The screens of the 2 cables must be connected as shown in the figure, but not connected to the chassis of the unit.

Continues on next page

3 Installation and commissioning

3.5.2 Connecting cables to the controller

Continued

Interference elimination

Internal relay coils and other units that can generate interference inside the control cabinet are neutralized. External relay coils, solenoids and other units must be clamped in a similar way. The illustration below shows how this can be done.

Note that the turn-off time for DC relays increases after neutralization, especially if a diode is connected across the coil. Varistors give shorter turn-off times. Neutralizing the coils lengthens the life of the switches that control them.

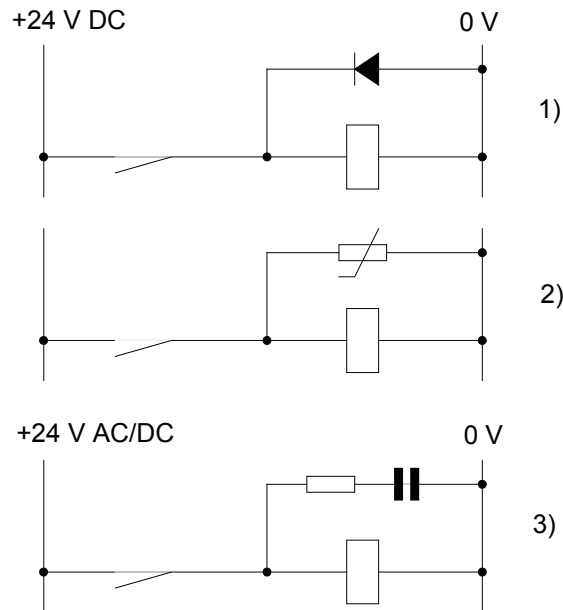

xx1200000961

- 1 The diode should be dimensioned for the same current as the relay coil, and a voltage of twice the supply voltage.
- 2 The varistor should be dimensioned for the same energy as the relay coil, and a voltage of twice the supply voltage.
- 3 When AC voltage is used, the components needs to be dimensioned for >500 V max voltage and 125 V nominal voltage.

The resistor should be 100 Ω , and the capacitor should be 1W 0.1 - 1 μF (typically 0.47 μF).

3.5.3 Connecting the manipulator to the controller

General

Connect the manipulator and the controller to each other after installing them. The lists below specify which cables to be used in each application.

All connectors on the controller are shown in section [Connectors on the OmniCore C90XT controller on page 70](#).



CAUTION

Verify that the serial number is according to the number(s) in the *Declaration of Incorporation (DoI)*.

Main cable categories

All cables between the manipulator and the controller are divided into the following categories:

Cable category	Description
Manipulator cable	Handles power supply to and control of the manipulator's motors as well as feedback from the serial measurement board.
Position switch cables (option)	Handles supply to and feedback from any position switches.
Customer cables (option)	Handles communication with equipment fitted on the manipulator by the customer.
Additional axes cables (option)	Handles power supply to and control of the external axes motors as well as feedback from the servo system.

These categories above are divided into sub-categories which are specified in spare part manual. See [Manipulator cables on page 477](#).

Connecting the cables from the manipulator to the controller

	Action
1	Connect the manipulator cable to the connector X1.
2	Lock the connector with the lever.
3	Secure the cables to avoid tripping or wear.

3 Installation and commissioning

3.5.4 Fitting the connector for incoming mains

3.5.4 Fitting the connector for incoming mains

General

This section describes how to manufacture a cable for connecting the main power to the controller.

Detailed view

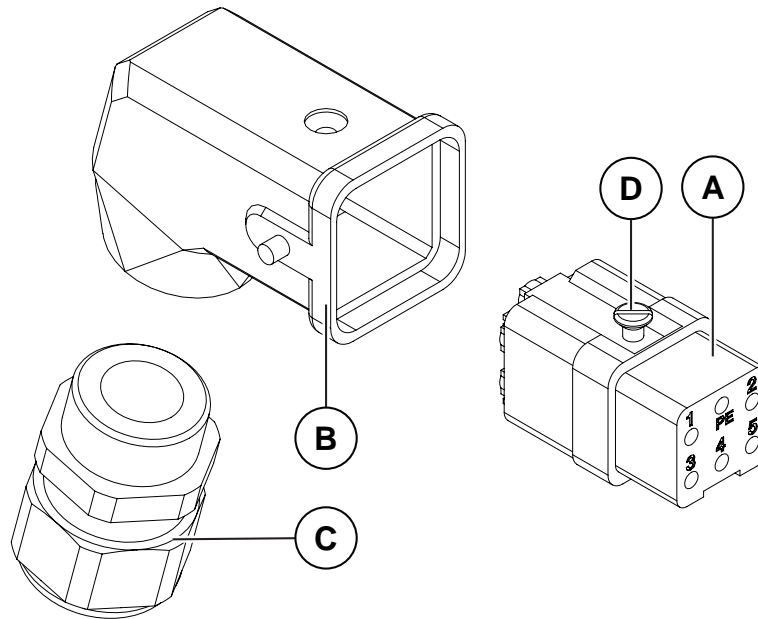

xx1900001457

	Description
A	Female insert, quick lock
B	Angle hood M20
C	Cable gland M20
D	Sealing screw

Specifications

The following describes the cable requirements for the incoming mains connection to the OmniCore C90XT controller.

Component	Description
Cable type	Flexible oil resistant rubber
Cable area	3C x 2.5 mm ² or AWG14
Protective earth	PE1 and PE2 points on X0 (incoming mains connector).

Included parts

The following parts are included in the delivery.

Part	Order number	Quantity
Power connector	3HAC070308-001	1

Continues on next page

3 Installation and commissioning

3.5.4 Fitting the connector for incoming mains

Continued

Procedure

Use the following procedure to fit the connectors.

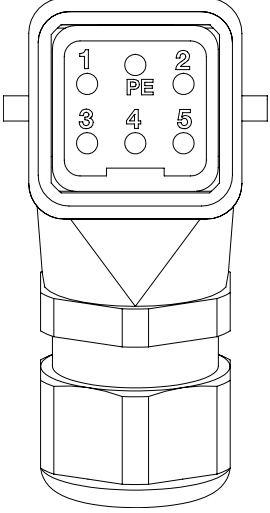
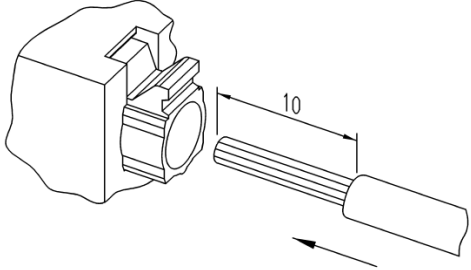
	Action	Note/illustration
1	Cut the cable to desired length.	
2	Connect the wires according to the illustration.	 <p data-bbox="954 969 1066 992">xx1900001454</p> <p data-bbox="954 1003 1150 1032">For single phase:</p> <ul data-bbox="986 1032 1283 1189" style="list-style-type: none">1 Live (L1)2 Neutral (N) or Live (L2)3 Not used4 Not used5 Not used <p data-bbox="979 1189 1334 1218">PE, Protective Earth, grounding</p>
3	Remove cable jacket and strip the fine stranded wires about 10 mm if needed.	 <p data-bbox="954 1525 1066 1547">xx1900001458</p>

Continues on next page

3 Installation and commissioning

3.5.4 Fitting the connector for incoming mains

Continued

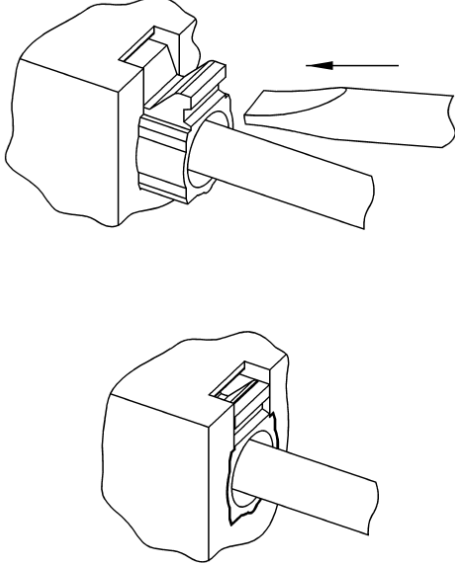
	Action	Note/illustration
4	Push fine stranded wires into the Han-Quick Lock contact and push the slide with a screw driver until it comes to a stop.	 <p data-bbox="922 900 1031 918">xx1900001459</p>

3.5.5 Connecting incoming mains and protective earth to the controller

Introduction



Note

How to manufacture a cable with connector is described in section [Fitting the connector for incoming mains on page 80](#).



DANGER

A residual current device (RCD) must be installed. See [Residual current on page 42](#).

Prerequisites

Before incoming mains is connected to the controller, the following prerequisites must be fulfilled:

- An external circuit breaker or fuse must be installed. See [Line fusing on page 86](#).
- The cabinet must be connected to protective earth. See [Connection of protective earth on page 84](#).
- A residual current device (RCD) must be installed. See [Residual current on page 42](#).

Continues on next page

3 Installation and commissioning

3.5.5 Connecting incoming mains and protective earth to the controller

Continued

Location of incoming mains connection



xx1900001479

Connection of protective earth



Note

The whole cabinet ground is connected to the X0.PE point.

Continues on next page

3 Installation and commissioning

3.5.5 Connecting incoming mains and protective earth to the controller

Continued

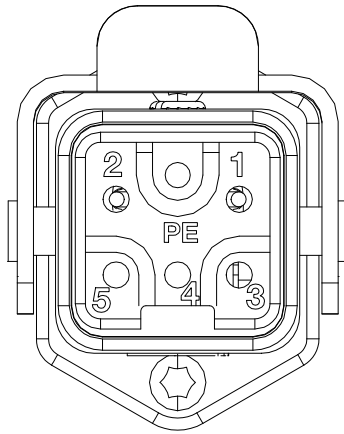

xx1900001455

	Description
1	Live (L1)
2	Neutral (N) or Live (L2)
3	Not used
4	Not used
5	Not used
PE	Protective Earth, grounding

Required equipment

Equipment	Note
Main connection cable (single phase)	L, N, PE Details see Fitting the connector for incoming mains on page 80 .
External earth fault protection (residual current device, RCD)	30 mA
Standard toolkit	See Standard toolkit for controller on page 448 .
Circuit diagram	Circuit diagram - OmniCore C90XT, 3HAC065464-009

Connecting the power

The following procedure describes how to connect the main power to the controller.



CAUTION

Always inspect the connector for dirt or damage before connecting it to the controller. Clean or replace any damaged parts.

Continues on next page

3 Installation and commissioning

3.5.5 Connecting incoming mains and protective earth to the controller

Continued

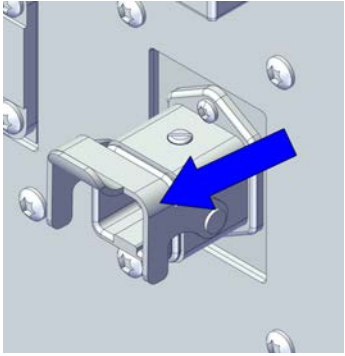
	Action	
1	<p>Connect the main power cable to the incoming mains connector X0 and lock it by pressing the locking levers.</p> <p> Tip</p> <p>When you hear a clear clicking sound, it is locked.</p>	 <p>xx1900001456</p>

Line fusing

There is no integrated fuse in side OmniCore C90XT controller. An external fuse or circuit breaker must be added by the integrator, according to the full load current rating. The full load current for the robot is marked on the controller name plate, and is also displayed in section [Line fusing on page 41](#).

3.5.6 Detaching and attaching a FlexPendant

Introduction

With the option *Hot swappable FlexPendant [3018-1]* it is possible to detach and attach the FlexPendant from an OmniCore controller in automatic mode, without interrupting the ongoing process.

Detaching the FlexPendant in manual mode will always result in an emergency stop.



Note

Detaching the FlexPendant is possible only if the logged in user has the **Detach the FlexPendant** grant.



CAUTION

Before detaching the FlexPendant, another emergency stop shall be available.



CAUTION

With a detached FlexPendant, there is no visual identification of the operating mode.



CAUTION

A FlexPendant that is not connected to the robot must be stored out of sight so that it cannot be mistaken for being in use.



CAUTION

The FlexPendant connector shall only be used to connect the FlexPendant.

Location of FlexPendant connector

The FlexPendant connector is located on the front panel on the controller.

The FlexPendant connector is located on the cabinet door.

Detaching the FlexPendant in automatic mode

Use the following procedure to detach the FlexPendant in automatic mode:

- 1 On the status bar, tap the **QuickSet** button.
- 2 Tap the **Logout/Restart** tab.
- 3 In the **FlexPendant** section, tap **Detach FlexPendant**.

Continues on next page

3 Installation and commissioning

3.5.6 Detaching and attaching a FlexPendant

Continued

The **Detach FlexPendant** window is displayed.

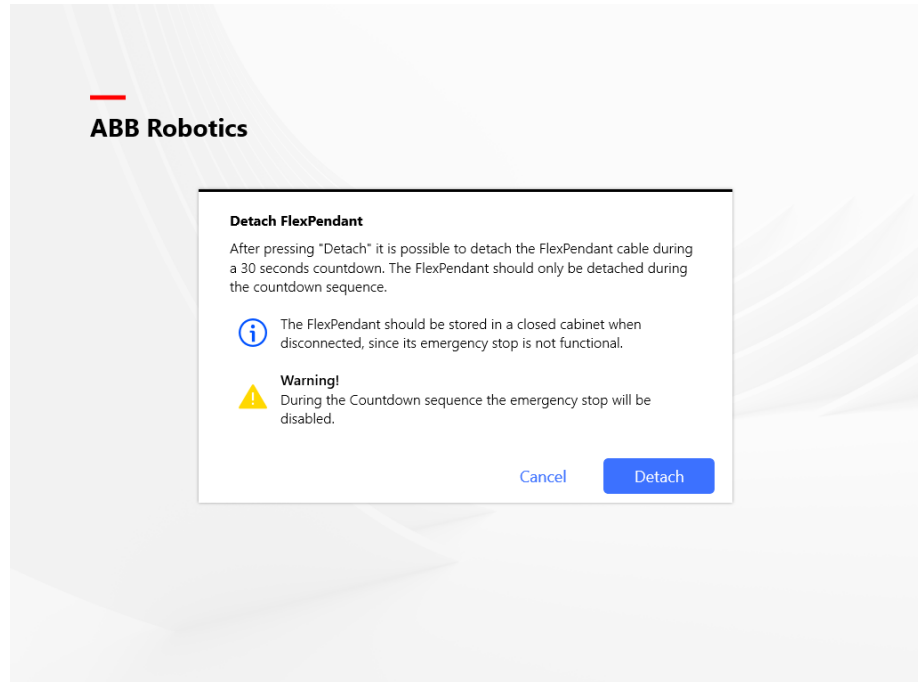

xx1900000403

4 Tap **Detach**.

A popup window with 30 seconds countdown timer is displayed.

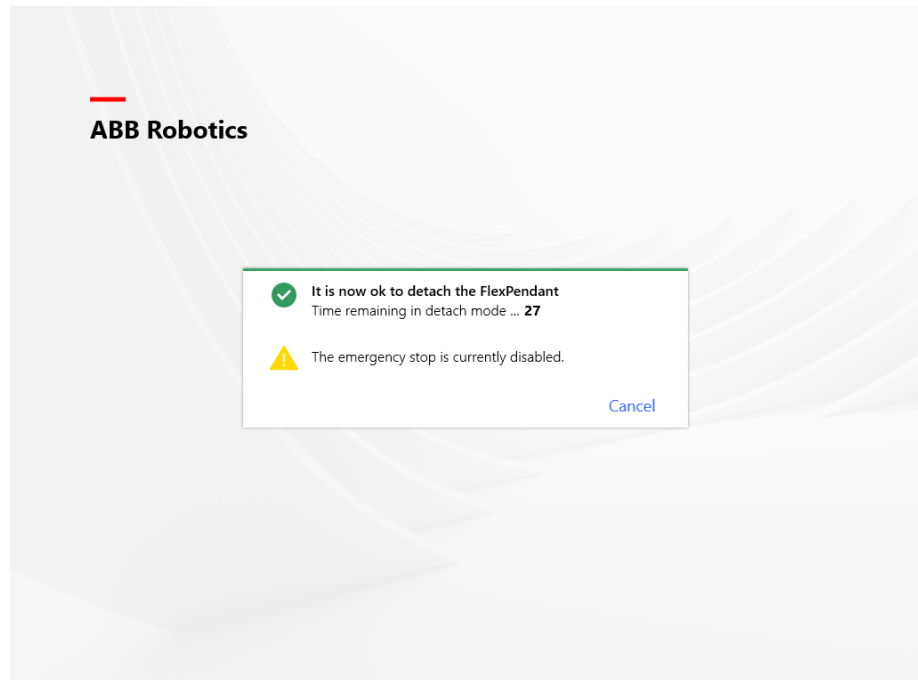

xx1900000404

5 When the countdown is progressing, detach the FlexPendant.

Continues on next page

When detached, the FlexPendant will shut down.



Note

If the FlexPendant is not detached within 30 seconds, the process for detach of the FlexPendant is aborted.



WARNING

If the FlexPendant is detached after the 30 seconds countdown has passed, the controller will enter emergency stop state.

Attaching the FlexPendant



CAUTION

Always inspect the connector for dirt or damage before attaching. Clean or replace any damaged parts.

Attach the connector to the controller and tighten the locking ring or screws.

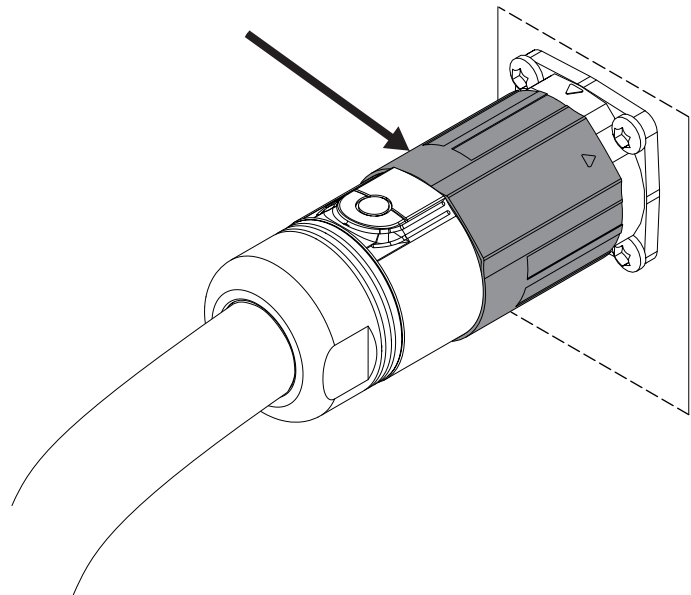

xx190000975



CAUTION

Make sure that the emergency stop device is not pressed in before attaching the FlexPendant.

3 Installation and commissioning

3.5.7 Ethernet networks on OmniCore

3.5.7 Ethernet networks on OmniCore

Network segment overview

The Ethernet networks used by OmniCore are distributed into the following segments:

Network segment	Controller ports	Usage
Private Network	I/O (Scalable I/O) ETHERNET SWITCH	Process equipment local to this specific robot.
	MGMT (Management)	ABB service personnel.
	HMI (FlexPendant)	FlexPendant connection.
Ability Network	ABB Ability™	ABB Ability™ connection.
Public Network	WAN	Public/factory network.
I/O Network	LAN	Secondary public/factory network. Isolated from WAN.

Continues on next page

Connectors

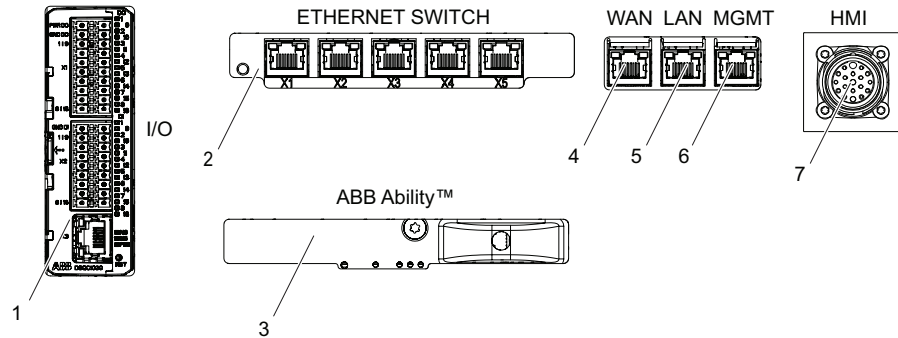

xx2100002082

	C line/V line controller label	Description
1	I/O	ABB Scalable I/O. Connected to the controller's Private Network. Intended for chaining more ABB Scalable I/O units.
2	ETHERNET SWITCH	Connected to the controller's Private Network. Intended for connecting ABB Scalable I/O units and network based process equipment local to the controller.
3	ABB Ability™	Intended for connecting the controller to internet/ABB Ability™.
4	WAN	Connected to the controller's Public Network. Intended for connecting the robot controller to a factory wide industrial network.
5	LAN (C30) LAN3 (C90XT and V line)	Connected to the controller's I/O Network. Intended for connecting the robot controller to a factory wide industrial network isolated from WAN.
6	MGMT (Management)	<p>Connected to the controller's Private Network. The MGMT port shall be used by service personnel in close proximity to the controller, with a single client connected to the controller.</p> <p> Note</p> <p>The management port shall never be used for more than one client at a time. ABB Robotics assumes no responsibility for any errors/hazards that may appear when more than one client is used.</p>
7	HMI (FlexPendant)	Specific connector for connecting the FlexPendant.

3 Installation and commissioning

3.5.8 Descriptions for connectors

3.5.8 Descriptions for connectors

Robot signal exchange proxy mating connectors

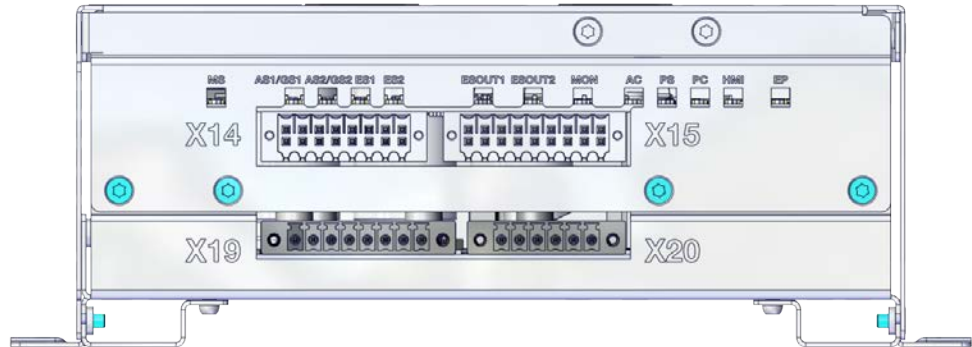

xx1900002449



CAUTION

Safety functions must be verified before use. Safety functions must be tested regularly.

Connector X14

	Description
Connection	Customer Safety Interface: Automatic Stop/General Stop and external Emergency Stop
Type	Weidmüller B2CF 3.50/16/180F B2CF 3.50/16/180F SN OR BX 2*8 pins
Article number	3HAC064736-001

The connector X14 allows for connecting *protective stop* and *emergency stop* devices.

The input for protective stop can either be configured as *Automatic Stop* (AS) or *General Stop* (GS). *Automatic Stop* is only operational in automatic mode. *General Stop* is operational in both manual mode and automatic mode. See [Protective stop and emergency stop on page 23](#).

The default configuration for the protective stop function is *Automatic Stop* (AS). That is, active in automatic mode only.

Changes to the default configuration for the protective stop function, that is from *Automatic Stop* (automatic mode) to *General Stop* (both manual and automatic mode), are done in RobotStudio, **Visual SafeMove**. See [Configuring robot stopping functions on page 106](#). More information is also available in *Application manual - Functional safety and SafeMove*.

External emergency stop devices can for example be required in the following cases:

- FlexPendant is detached.

Continues on next page

3 Installation and commissioning

3.5.8 Descriptions for connectors

Continued

- FlexPendant is placed in its holder with the emergency stop device hidden behind the emergency stop device cover.

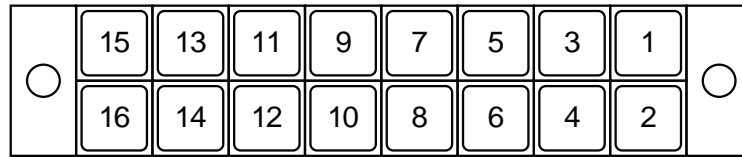

xx1800000553

Pin	Name	Description
1	0V_CH1_CH2	Reference ground towards 24 V.
2	24V_CH2	24 V power, provided by robot controller, for ES channel 2 only.
3	ES2-	Negative side of external emergency stop input, channel 2.
4	ES2+	Positive side of external emergency stop input, channel 2.
5	ES1-	Negative side of external emergency stop input, channel 1.
6	ES1+	Positive side of external emergency stop input, channel 1.
7	0V_CH1_CH2	Reference ground towards 24 V.
8	24V_CH1	24 V power, provided by robot controller, for ES channel 1 only.
9	0V_CH1_CH2	Reference ground towards 24 V.
10	24V_CH2	24 V power, provided by robot controller, for AS/GS channel 2 only.
11	AS2/GS2-	Negative side of AS/GS input, channel 2. Customer needs to connect these pins to the reference ground of 24 V power.
12	AS2/GS2+	Positive side of AS/GS input, channel 2. Customer needs to connect these pins to a 24 V power.
13	AS1/GS1-	Negative side of AS/GS input, channel 1. Customer needs to connect these pins to the reference ground of 24 V power.
14	AS1/GS1+	Positive side of AS/GS input, channel 1. Customer needs to connect these pins to a 24 V power.
15	0V_CH1_CH2	Reference ground towards 24 V.
16	24V_CH1	24 V power, provided by robot controller, for AS/GS channel 1 only.



Note

The emergency stop and protective stop will activate when the voltage is between 11.4 V and 21.5 V.

Continues on next page

3 Installation and commissioning

3.5.8 Descriptions for connectors

Continued

A protective stop device needs to be connected to the protective stop input. See example below.

Customer provided protective stop device

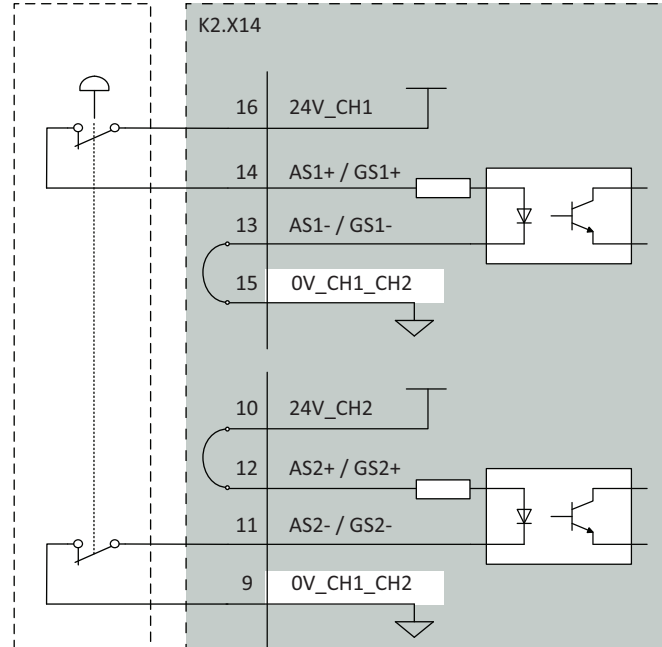

xx2100002262

The protective stop input can be powered from an external power supply:

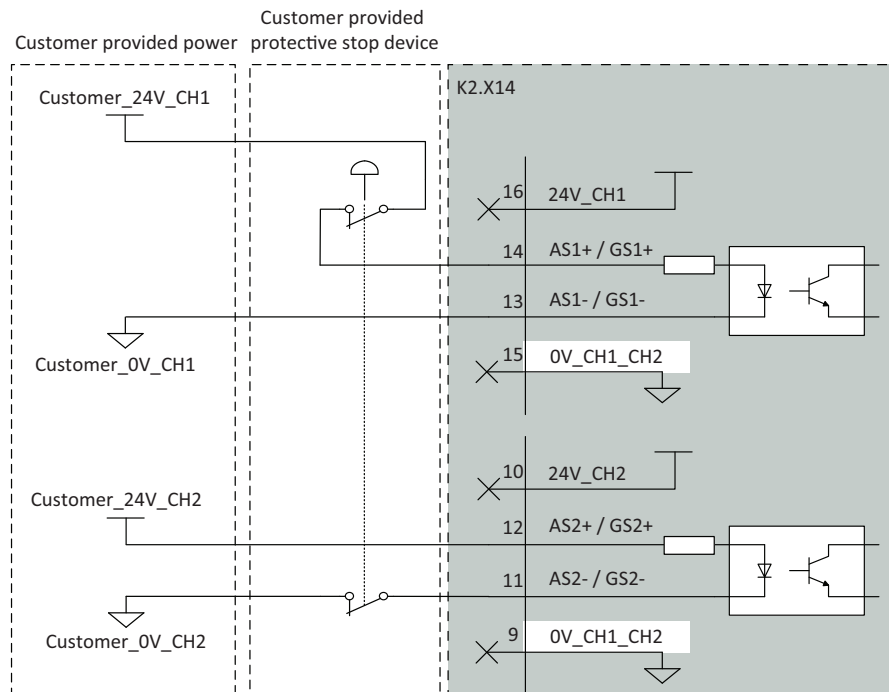

xx2100002264

Continues on next page

The emergency stop input needs to be connected to an emergency stop device. This to allow operation in both automatic and manual mode:

Customer provided emergency stop device

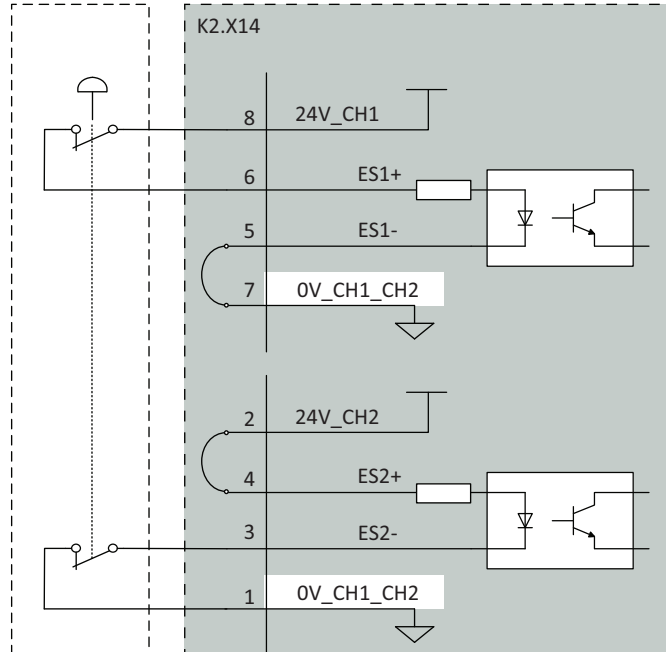

xx2100002261

The emergency stop input can be powered from an external power supply:

Customer provided power emergency stop device

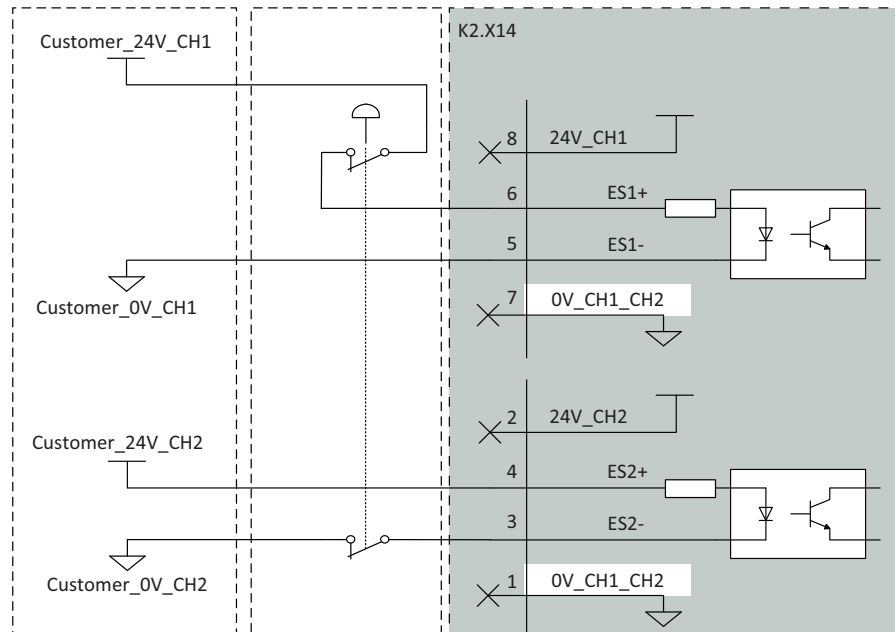

xx2100002263

For more connections other than those illustrated above, carefully assess the risk before use and contact your local ABB for support.

Continues on next page

3 Installation and commissioning

3.5.8 Descriptions for connectors

Continued

Connector X15

	Description
Connection	Customer Optional Interface
Type	Weidmüller B2CF 3.50/18/180F B2CF 3.50/18/180F SN OR BX 2*9 pins
Article number	3HAC064737-001



xx180000555



Note

NC means those pins are reserved. They cannot be electrically connected to any external signal, ground, or voltage.

Pin	Name	Description
1	MON_PB	Motors on push button input interface.
2	24V_MON	24 V power supplied by robot controller for motors on lamp and motors on push button use only. It must not be used for any other functions.
3	MON_LAMP	Motors on lamp output interface. The max sink current is 50mA.
4	24V_MON	24 V power supplied by robot controller for motors on lamp and motors on push button use only. It must not be used for any other functions.
5	NC	Reserved
6	NC	Reserved
7	NC	Reserved
8	NC	Reserved
9	NC	Reserved
10	NC	Reserved
11	ESOUT2-	Negative side of emergency stop output, channel 2.
12	ESOUT2+	Positive side of emergency stop output, channel 2.
13	ESOUT1-	Negative side of emergency stop output, channel 1.
14	ESOUT1+	Positive side of emergency stop output, channel 1.
15	NC	Reserved
16	NC	Reserved

Continues on next page

Pin	Name	Description
17	NC	Reserved
18	NC	Reserved



Note

The ESOUT1 and ESOUT2 fulfill the IEC 61131-2 current-sourcing digital output Type 0,25.

0V DC as nominal state 0. State 0 shall be recognized as Emergency stop triggered. 24V DC as nominal state 1. State 1 shall be recognized as normal status.

It is not allowed to connect these power sourcing discrete digital outputs to any external power sources.



Note

The device connected to the ESOUT pins shall fulfill the IEC 61131-2 Type 1 Input.

If the device cannot meet the requirement, a safety PLC or relay is needed.

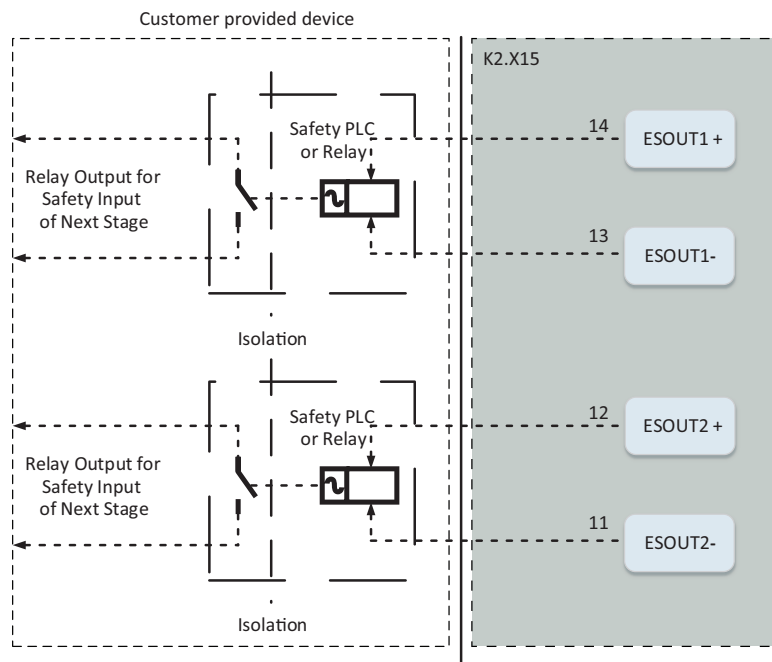

xx2000001763



Note

The maximum length of the cable connected to the ESOUT pins shall be 10 m.

Continues on next page

3 Installation and commissioning

3.5.8 Descriptions for connectors

Continued



Note

The cable shall be protected from external EM disturbance, suggested to use separate multicore cables.



Note

The ESOUT pins reflect the emergency status of the controller.

ESOUT can be decoupled from ES input to avoid dead-lock in an emergency stop chain, when using RobotWare 7.6 or later. On controllers running RobotWare releases prior to 7.6, it is not recommended to directly connect ESOUT pins to the ES pins on another OmniCore controller. See [Configuring robot stopping functions on page 106](#).

Although the Motors On function is available on the FlexPendant, an interface is provided in X15 for an optional Motors On push button and an indication lamp.

Customer provided device

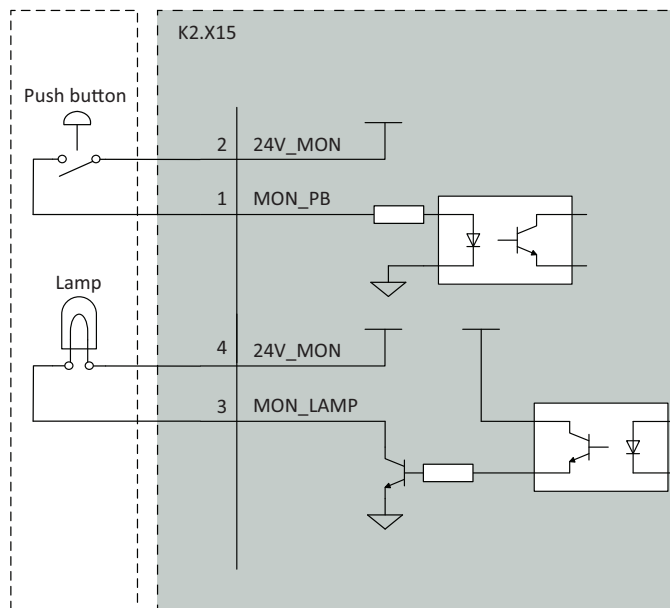

xx190000598

Connector X19

	Description
Connection	Customer IO power supply
Type	Weidmüller BCF 3.81/08/180F BCF 3.81/08/180F SN BK BX 8 Pins
Article number	3HAC064739-001

Continues on next page

3 Installation and commissioning

3.5.8 Descriptions for connectors

Continued

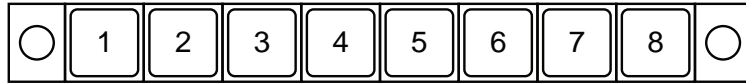

xx180000556

Pin	Name	Description
1	24V_IO_EXT_1	24V_IO_EXT
2	0V_IO_EXT_1	0V_IO_EXT
3	24V_IO_EXT_2	24V_IO_EXT
4	0V_IO_EXT_2	0V_IO_EXT
5	24V_IO_EXT_3	24V_IO_EXT
6	0V_IO_EXT_3	0V_IO_EXT
7	24V_IO_EXT_4	24V_IO_EXT
8	0V_IO_EXT_4	0V_IO_EXT

24V_IO_EXT is the 24 V power supply for the customer. The characteristics are shown in the following table.

Parameter	Value
Voltage	24V DC
Voltage tolerance	-3% ~ +10%
Max output current	3 A

Connector X20

	Description
Connection	Customer optional power input (Not available)
Type	Weidmüller BCF 3.81/06/180F BCF 3.81/06/180F SN BK BX 6 Pins
Article number	3HAC064738-001

Continues on next page

3 Installation and commissioning

3.5.8 Descriptions for connectors

Continued

Antenna connector

The Connected Services Gateway unit has either an ABB Connect port or an antenna connector on the front. See installation procedures in section [On-site installation on page 58](#).

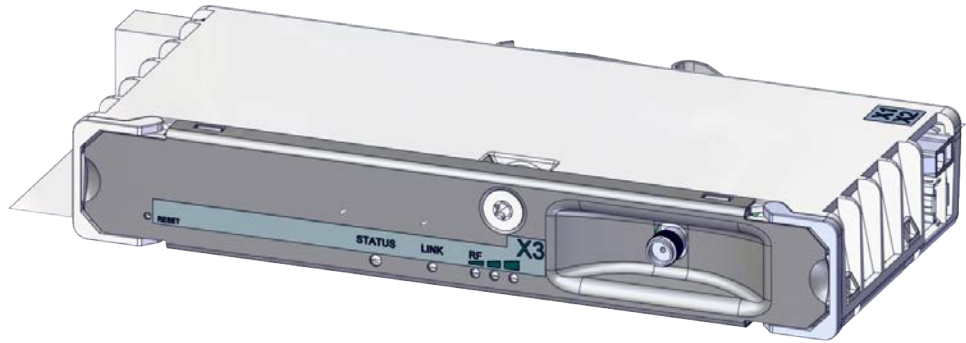

xx1900002450

Customer cable layout

The antenna should go through the cable grommet and fasten on the cabinet.



Note

The end user needs to install proper grommets according to the diameter of the cables which need to go through the grommet.

Incorrect use of grommets will affect ingress protection, EMI/EMC and temperature.

It is recommended to use icotek KT grommet.

The cable layout is recommended as the following illustration.

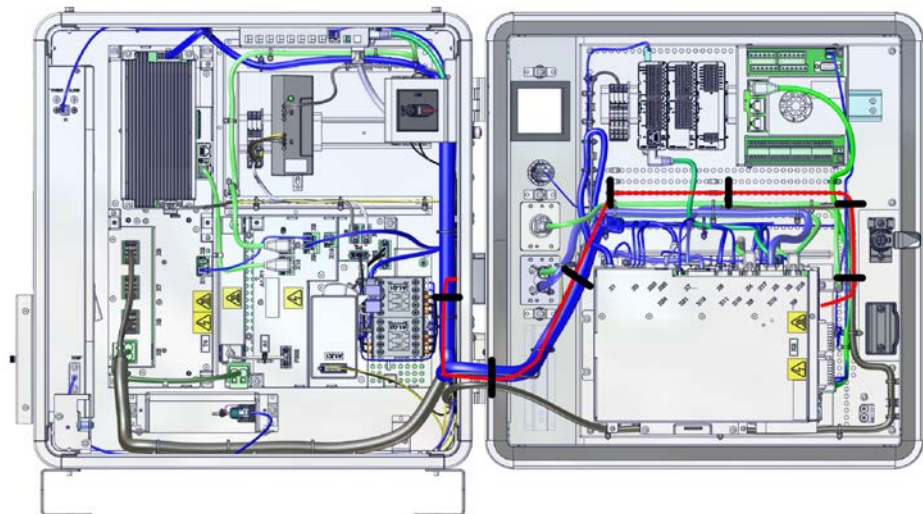

xx2000000436

Continues on next page

I/O connectors - Scalable I/O (option)

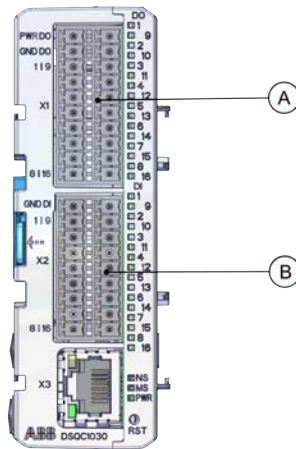

xx1900002448

A	Scalable I/O output connectors
B	Scalable I/O input connectors

The connectors contain 16 digital input signals, 16 digital output signals, 24 V and 0 V for the outputs, and 0 V for the inputs.

For connection details, see *Circuit diagram - OmniCore C90XT*, 3HAC065464-009 and *Application manual - Scalable I/O*, 3HAC070208-001.

Customer cable layout

It is recommended to use multicore cable for the customer connection.

The cables connected by customer to the I/O unit should go through the cable grommet and fasten on the cabinet.



Note

The end user need to buy proper grommets according to the diameter of the cables which need to go through the grommet.

This will affect the protection level of the cabinet if it's not executed correctly.

It is recommended to use icotek KT grommet.

Continues on next page

3 Installation and commissioning

3.5.8 Descriptions for connectors

Continued

The cable layout is recommended as the following illustration.

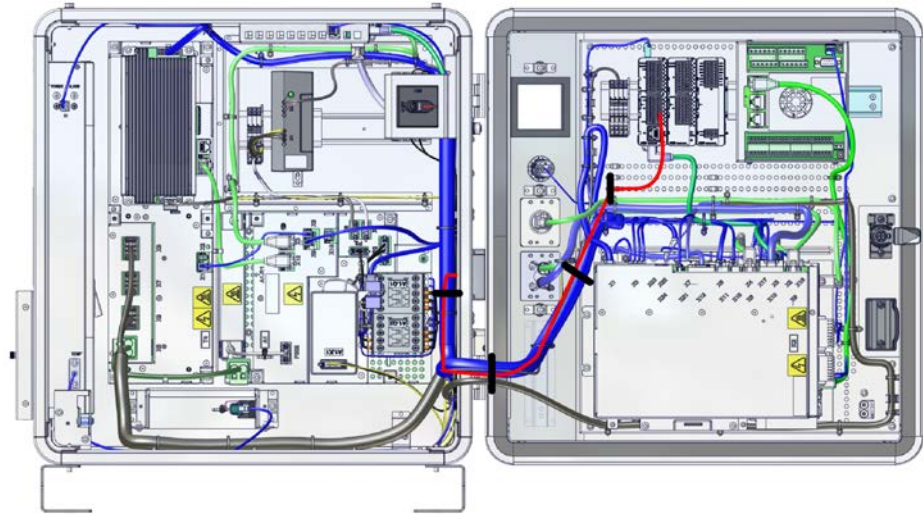

xx200000434

DeviceNet board connector (option)

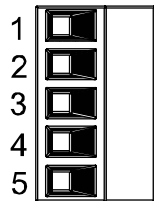

xx020000292

The following table shows the connections to the DeviceNet connector:

I/O pin	Signal name	Wire color	Function
1	V-	black	DeviceNet network negative power (0 V)
2	CANL	blue	DeviceNet communication network terminal (low)
3	Shield	bare	Network cable shield
4	CANH	white	DeviceNet communication network terminal (high)
5	V+	red	DeviceNet network positive power (24 V DC)



Tip

The DeviceNet network needs to be powered by a separate 24 V power supply, or the DeviceNet function will not work.

See *Application manual - DeviceNet Master/Slave, 3HAC066562-001*, section "Hardware overview" for more information on how to connect 24 V to the DeviceNet network.

For connection details, see *Circuit diagram - OmniCore C90XT, 3HAC065464-009*.

Continues on next page

Conveyor tracking module (option)

For detail information on customer connections to conveyor tracking module, see *Application manual - Conveyor tracking, 3HAC066561-001*.

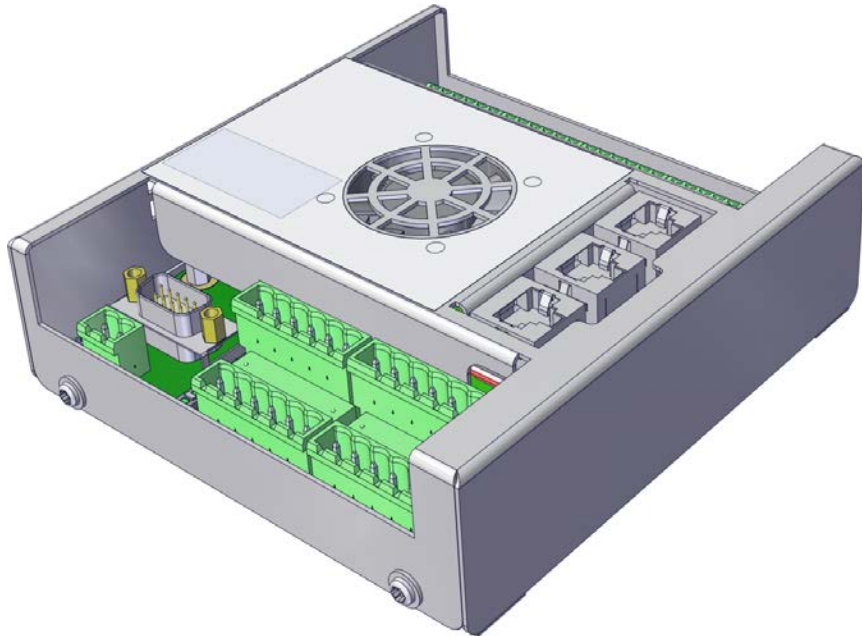

xx2100002526

Customer cable layout

It is recommended to use multicore cable for the customer connection.
The cables connected by customer to the conveyor tracking module should go through the cable grommet and fasten on the cabinet.



Note

The end user needs to install proper grommets according to the diameter of the cables which need to go through the grommet.

Incorrect use of grommets will affect ingress protection, EMI/EMC and temperature.

It is recommended to use icotek KT grommet.

Continues on next page

3 Installation and commissioning

3.5.8 Descriptions for connectors

Continued

The cable layout is recommended as the following illustration.

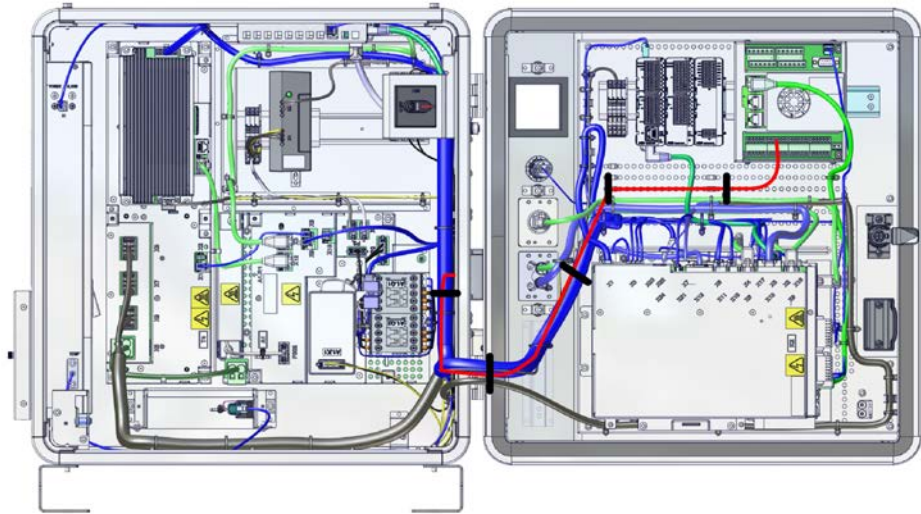

xx200000435

24V terminal block (option)

This connector is internally connected with the optional power supply. It is a 24 V power supply for the customer. The characteristics are shown in the following table.

Parameter	Value
Voltage	24 V DC
Voltage tolerance	-3% ~ +10%
Max output current	4 A



Note

The 24 V terminal block power supply is isolated from the internal logical circuit of the controller.

For connection details, see *Circuit diagram - OmniCore C90XT, 3HAC065464-009*.

Customer cable layout

It is recommended to use multicore cable for the customer connection.

The cables connected by customer to the 24 V terminal block should go through the cable grommet and fasten on the cabinet.



Note

The diameter of the cables must match the diameter of the grommet.

Incorrect installation will affect the ingress protection.

It is recommended to use icotek KT grommet.

Continues on next page

The cable layout is recommended as the following illustration.

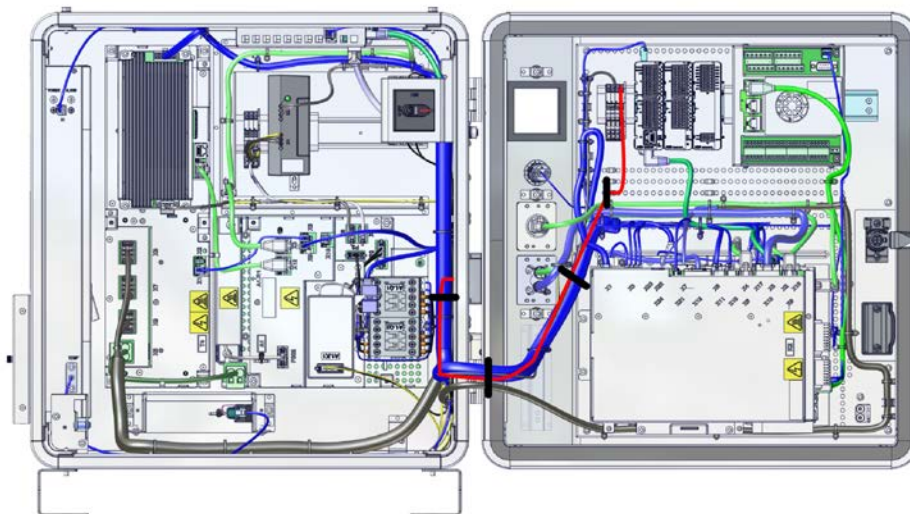

xx200000433

3 Installation and commissioning

3.5.9 Configuring robot stopping functions

3.5.9 Configuring robot stopping functions

Introduction

The robot stopping functions, protective and emergency stop, are configured using the *Visual SafeMove* functionality in RobotStudio. This includes the emergency stop device on the FlexPendant, and external stop functions.



Note

The safety stop configuration and available stops is different for OmniCore prior to RobotWare 7.3.

The protective stop function can be configured to be either an *Automatic Stop (AS)* or a *General Stop (GS)*. When the protective stop function is configured as *General Stop (GS)*, the activation of the protective stop device will initiate the protective stop in any operating mode. When the protective stop function is configured as *Automatic Stop (AS)*, the activation of the protective stop device will initiate the protective stop in automatic mode only.



Note

It is not possible to configure both *Automatic Stop* and *General Stop* on the OmniCore C90XT without the use of a safe fieldbus.



Note

The dedicated discrete safety input to activate the protective stop function can be configured as either *Automatic Stop (AS)* or *General Stop (GS)*. For simultaneous use of AS and GS, support for a safety protocol is required. See option *SafeMove*.

For more information about safety configurations, see *Application manual - Functional safety and SafeMove*.

Configure the robot stopping functions in Visual SafeMove



WARNING

The new settings must be verified by test before the robot is used.



Note

Depending on the controller variant and RobotWare version, the configuration options are different.

Not all configurations can be modified.

Continues on next page

Use this procedure to configure the robot stopping functions in Visual SafeMove.

1 In *Visual SafeMove*, select **Stop Configuration**.

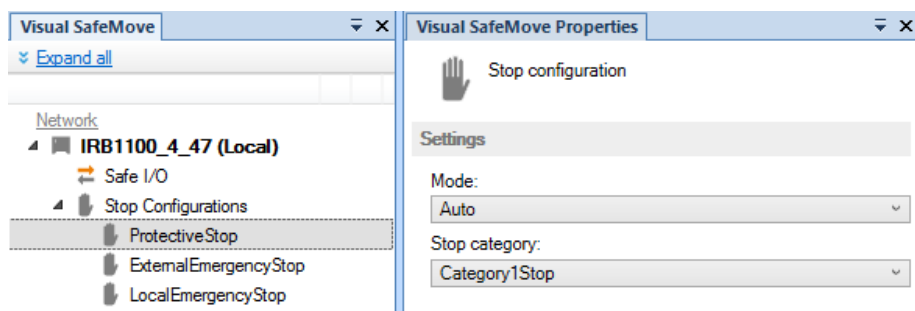

xx210000737

2 Select a stop configuration or right-click to create a new configuration.

3 For user-created stop configurations, select the signal that should trigger the stop in the **Trigger signal** dropdown menu.

- 0 = activate stop
- 1 = deactivate stop

4 For user-created stop configurations, if a status signal should be set when the functionality is active, select the signal to use in **Stop trigger status** dropdown menu.

If no output signal should be used, select **No signal**.

- 0 = stop triggered
- 1 = stop not triggered

5 Define the mode (automatic or manual).

- *ProtectiveStop* is the AS/GS input
- *ExternalEmergencyStop* is the ES input

To avoid dead-lock in an emergency stop chain, the *ExternalEmergencyStop* input can be decoupled from the ES output.

- *LocalEmergencyStop* is the emergency stop device on the FlexPendant

6 Select the stop category.

7 After the configuration is done, the safety configuration must be transferred to the controller and then a restart of the controller is required.



Tip

See also the circuit diagram, *Circuit diagram - OmniCore C90XT*.

3 Installation and commissioning

3.5.9 Configuring robot stopping functions

Continued

Apply the configuration to the controller

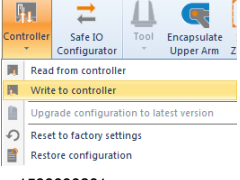
	Action	Note/illustration
1	In the Visual SafeMove ribbon, click on Controller and then select Write to controller .	 xx150000801
2	A report of the safety configuration is shown. The report can be printed by clicking on Print (it is recommended to print the report since it should be used when validating the configuration). Click OK to close the report.	
3	Answer Yes when asked if you want to restart the controller.	After the restart, the downloaded configuration is active. Before running in auto mode, the configuration should be validated and locked, see Validate the configuration of robot stopping functions on page 108 .

Validate the configuration of robot stopping functions



DANGER

A stop configuration must always be validated to verify that the desired safety is achieved.

	Action	Expected result
1	Deactivate any supervision functions that are signal activated.	
2	Move the robot, for example with a move instruction.	
3	Set the signal configured to stop the robot in relevant operating modes. Relevant operating modes are: <ul style="list-style-type: none"> • Auto: Automatic mode • General: All modes • EmergencyStop: All modes 	The robot will stop.

Set the configuration to validated

When the stop configuration is validated the configuration, the status of the configuration shall be changed to **Validated** on the FlexPendant.

- 1 Log in as a user with the grant **Safety Services**.
- 2 In the **Settings** app, select the **Safety Controller**, and then **Configuration**.
- 3 Select the check box **Validated**.

Set the configuration to locked

When the stop configuration is approved, the status of the configuration should be changed to **Locked** on the FlexPendant.

Continues on next page

Running the robot in auto mode with the configuration unlocked will result in a warning message.

- 1 Log in as a user with the grant **Lock Safety Controller Configuration**.
- 2 In the **Settings** app, select the **Safety Controller**, and then **Configuration**.
- 3 Select the check box **Locked**.

Upgrading RobotWare

When upgrading RobotWare there can be differences in functionality, also when configuring the robot stopping functions. Always read the RobotWare release notes and verify the robot stopping functions by test after an upgrade. Contact your local ABB office for guidance.

RobotWare prior to 7.3

In RobotWare releases prior to 7.3, the stops are configured in the system parameters. If such a RobotWare system is upgraded to RobotWare 7.3, the stop configuration is still handled in the system parameters.

The general stop (GS) is not available in OmniCore prior to RobotWare 7.3. To include GS in an upgraded system, the safety configuration must be upgraded or a new safety configuration must be done.

RobotWare prior to 7.6

In RobotWare releases prior to 7.6, the ES input cannot be decoupled from the ES output.

The *LocalEmergencyStop* was named *InternalEmergencyStop* prior to RobotWare 7.6.

3 Installation and commissioning

3.5.10 Programmable stop functions

3.5.10 Programmable stop functions

Stopping functions

There are different methods to stop the robot, in addition to manually initiated stops.

- Stop with system input signals
- Stop with RAPID instructions
- Other stops

Stop with system input signals

In the control system, it is possible to define system input signals to be set/reset through different interactions, for example, through networks, I/O blocks, RobAPI, etc. See *next release version*.

Pre-defined system input	Description
<i>Stop</i>	The manipulator is stopped on the path with no deviation.
<i>QuickStop</i>	This is a faster stop of the manipulator than <i>SoftStop</i> . This stop is more stressing for the mechanics than <i>SoftStop</i> . <i>QuickStop</i> ignores torque and acceleration limits.
<i>Stop at End of Cycle</i>	Stops the RAPID program when the complete program is executed, that means when the last instruction in the main routine has been completed.
<i>Stop at End of Instruction</i>	Stops program execution after the current instruction is completed.

All of these stops are performed without using the brakes, and the power is never disconnected. The program execution can be continued directly, for example by activating a start signal.

Stop with RAPID instructions

There are several RAPID instructions available that stops the robot.

Instruction	Description	Arguments
<code>SystemStopAction</code>	Stops all robots in all tasks immediately.	<code>\Stop</code> : similar to a normal program stop with stop button. <code>\StopBlock</code> : as above, but to restart the PP has to be moved. <code>\Halt</code> : this is like a category 0 stop, i.e. it will result in motors off state, stop of program execution and robot movements in all motion tasks. The Motors on button must be pressed before the program execution can be restarted.
<code>Stop</code>	The current move instruction will be finished before the robot stops. A restart will continue the program execution.	<code>\NoRegain</code> : the robot will not return to the stop point when restarted, e.g. after having been jogged away. <code>\AllMoveTasks</code> : all robots will be stopped.

Continues on next page

Instruction	Description	Arguments
StopMove	The current move instruction will be stopped immediately as a soft stop but the program execution will continue with the next instruction. This is often used in for example trap routines.	\AllMotionTasks: all robots will be stopped.
BREAK	The current move instruction and the program execution will be stopped immediately as a normal program stop. A restart will continue the program execution.	
EXIT	The current move instruction and the program execution will be stopped immediately as a normal program stop. After stop the Program Pointer has to be reset to Main.	
EXITCYCLE	The current move instruction and program execution will be stopped immediately. The Program Pointer will be reset to Main and if running mode is continuous, the program will be restarted.	
SearchX	Search instructions can be programmed with arguments to stop the robot movement close to the point where a search hit was noticed. The program execution will continue with the next instruction.	<p>\Stop: Stiff stop - the robot will stop as fast as possible. This stop is performed by ramping down motion in each motor separate from each other, and as fast as possible. Since it will be without any coordination, the robot may slide off path fairly much.</p> <p>\SStop: Soft stop - the robot will stop on path.</p> <p>\Sup: the robot will continue to the ToPoint. If more than one search hit is found, an error will be reported.</p>

RAPID instructions are described in *Technical reference manual - RAPID Instructions, Functions and Data types*.

Other unexpected stops



Type of stop	Description
SysFail	In the control system there is a surveillance and monitoring function that can detect abnormal situations. In such cases a stop will be initiated. The robot controller must be restarted, and the configuration may have to be changed.
Power fail	In the control system there is a monitoring function that can detect power failure. At power fail, all execution will be stopped. After powerOn/motorsOn, it is possible to restart and continue the execution where it stopped.

Continues on next page

3 Installation and commissioning

3.5.10 Programmable stop functions

Continued

Type of stop	Description
Stop at collision	<p>In the control system there is a monitoring function that can detect collisions. When a collision is detected, a stop will be initiated.</p> <p>This functionality can be switched on/off using the system parameters for Motion/Motion Supervision.</p> <p> WARNING</p> <p>Special care must be taken when restarting a machine that is stopped due to a collision. The robot might make a limited movement when restarted.</p> <p> WARNING</p> <p>The revolution counters might need to be updated after a collision to ensure path accuracy.</p>

Stopping time/distance

Stopping time and distance metric for stop category 0 and stop category 1 are detailed in the product specification for the respective manipulator.

The data is valid for floor mounted manipulators, without any tilting.

3.6 I/O system

3.6.1 Available industrial networks

General

The controller can be fitted with a number of different fieldbus adapters, fieldbus boards, and software based fieldbuses. The software based fieldbuses do not require any hardware.



Note

Two industrial network masters can be run in parallel on the OmniCore controller. It is the responsibility of the integrator to verify the behavior when two masters are used in one OmniCore.

Fieldbus connections

There is one slot available for installing a fieldbus board (PCIe) on the main computer, with process connectors on the front panel, and one slot for installing a fieldbus adapter (slave).

The software based fieldbuses are connected directly to one of the Ethernet ports.

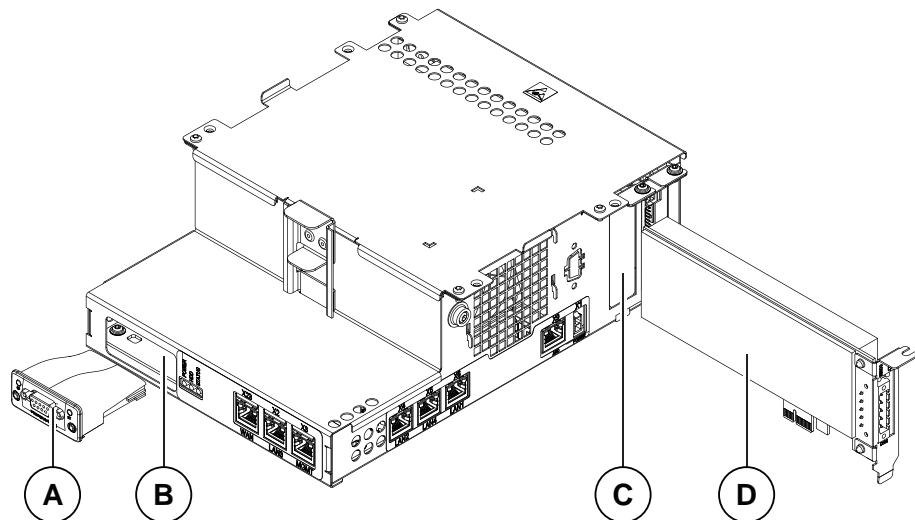

xx170000748

A	Fieldbus adapter (slave)
B	Slot for fieldbus adapters
C	Slot for fieldbus, PCI express card
D	Fieldbus board (master)

Available board

The following master board is available.

Description	Article number	Type designation
DeviceNet Board	3HAC043383-001	DSQC1006

Continues on next page

3 Installation and commissioning

3.6.1 Available industrial networks

Continued

Available software based fieldbuses

The following software based fieldbuses are available as RobotWare options.

- EtherNet/IP
- PROFINET
- CC-Link IE Field Basic

Available adapter

The following fieldbus adapter slave is available.

Description	Article number	Type designation
DeviceNet Slave Fieldbus Adapter	3HAC045973-001	DSQC1004

References

For more information on how to install and configure the fieldbuses, see the respective manual.

Manual title	Article number
<i>Application manual - DeviceNet Master/Slave</i>	<i>3HAC066562-001</i>
<i>Application manual - EtherNet/IP Scanner/Adapter</i>	<i>3HAC066565-001</i>
<i>Application manual - PROFINET Controller/Device</i>	<i>3HAC066558-001</i>
<i>Application manual - I/O Engineering</i>	<i>3HAC082346-001</i>
<i>Application manual - CC-Link IE Field Basic</i>	<i>3HAC082295-001</i>

3.6.2 Scalable I/O, internal and external

General

The controller can be fitted with an I/O base unit, DSQC1030, providing 16 digital inputs and 16 digital outputs. If more I/O is needed, additional I/O units can be attached to the I/O base unit.

Scalable I/O units

The I/O unit *DSQC1030 Digital Base* belongs to the ABB Scalable I/O system, which is a modular, compact, and scalable I/O system that consists of a base device (minimum configuration), and add-on devices.

The *DSQC1042 Safety Digital Base* is a device that can be used to control and monitor machine safety equipment. The device can be used together with the scalable I/O units.

For information about configuring and using the scalable I/O devices, see *Application manual - Scalable I/O*.

For information about installing the scalable I/O devices, see [Installing the scalable I/O devices on page 120](#).

3 Installation and commissioning

3.7.1 Installing the harness for double SMB

3.7 Installing options

3.7.1 Installing the harness for double SMB

Location

The illustration shows the location of the harness double SMB in the controller.



xx200000448

Required spare parts



Note

The spare part numbers that are listed in the table can be out of date. See the latest spare parts of the OmniCore C90XT via myABB Business Portal, www.abb.com/myABB.

Spare part	Article number	Note
Harness Single SMB connection	3HAC069674-001	Harness single SMB
Harness Double SMB connection	3HAC069675-001	Harness double SMB

Continues on next page

3 Installation and commissioning

3.7.1 Installing the harness for double SMB

Continued

Required tools and equipment



Equipment	Article number	Note
Standard toolkit	-	Content is defined in section Standard toolkit for controller on page 448 .
ESD protective wrist band	-	

Required documents

Document	Article number	Note
Circuit diagram - OmniCore C90XT	3HAC065464-009	

Installing the harness double SMB

Preparations

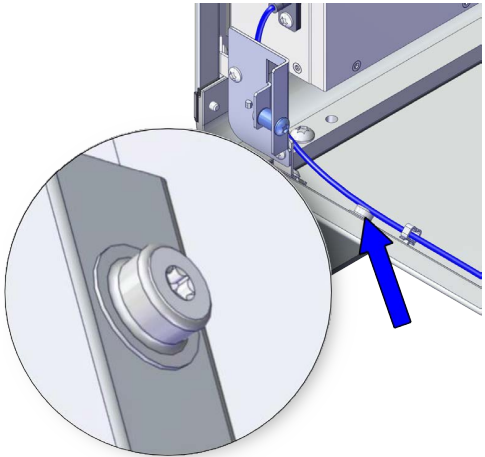
	Action	Note/Illustration
1	 DANGER Before doing any work inside the cabinet, disconnect the mains power. For more information, see Electrical safety on page 31 .	
2	Open the door.	Opening the door on page 188 .
3	 ELECTROSTATIC DISCHARGE (ESD) The unit is sensitive to ESD. Before handling the unit read the safety information in section The unit is sensitive to ESD on page 44 .	Location of wrist strap button:  xx1900001446

Continues on next page

3 Installation and commissioning

3.7.1 Installing the harness for double SMB

Continued

Removing the harness for signal SMB

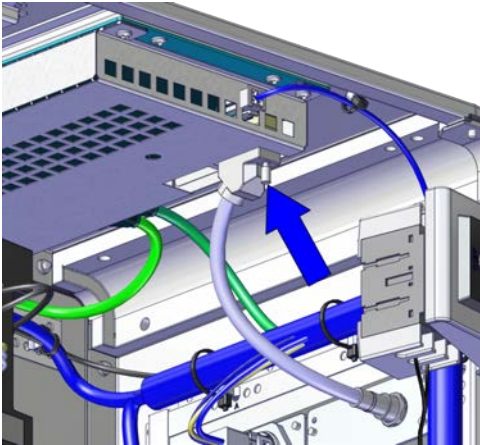
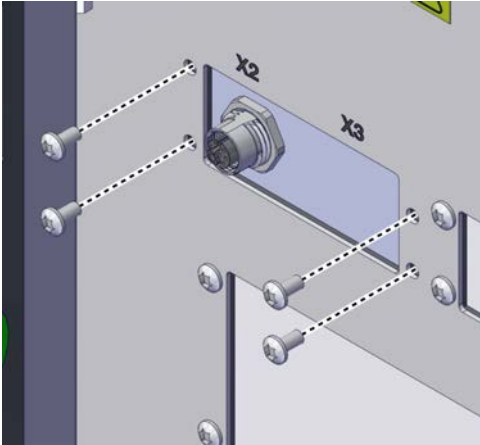
	Action	Note/Illustration
1	Loosen the screw and disconnect: <ul style="list-style-type: none"> SMB - K6.X4 	 <p>xx1900001914</p>
2	Remove the attachment screws on the cover.	 <p>xx1900001915</p>
3	Push the manipulator signal connector into the cabinet.	
4	Take the manipulator signal connector out.	

Refitting the harness for double SMB

	Action	Note/Illustration
1	 <p>DANGER</p> <p>Before doing any work inside the cabinet, disconnect the mains power. For more information, see Electrical safety on page 31.</p>	

Continues on next page

3 Installation and commissioning

3.7.1 Installing the harness for double SMB

Continued

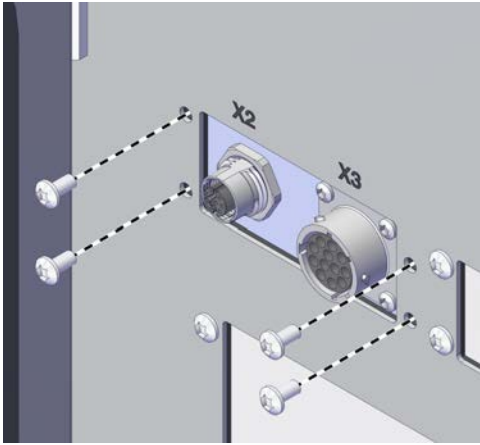
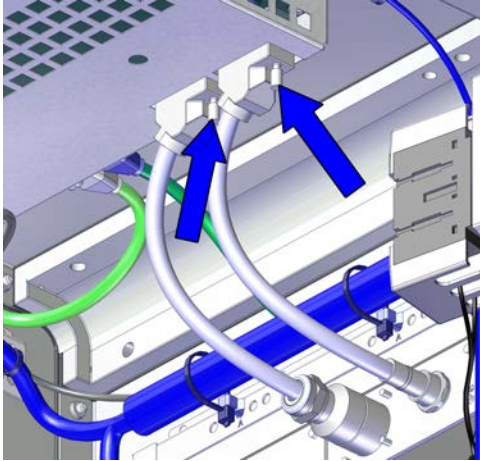
	Action	Note/Illustration
2	 ELECTROSTATIC DISCHARGE (ESD) The unit is sensitive to ESD. Before handling the unit read the safety information in section The unit is sensitive to ESD on page 44 .	
3	Insert the manipulator signal connector into the cover from inner side of the cabinet.	
4	Secure it with the attachment screws.	Screws: Torx pan head screw M4x8 (4 pcs)  xx2000000440
5	Reconnect and secure: <ul style="list-style-type: none"> • K6.X4, K6.X5 - SMB. 	 xx2000000439

Concluding procedure

	Action	Note/Illustration
1	Close the door.	Closing the door on page 188 .
2	Perform the function tests to verify that the safety features work properly, see Function tests on page 178 .	

3 Installation and commissioning

3.7.2 Installing the scalable I/O devices

3.7.2 Installing the scalable I/O devices

Location

The location of the base unit used as a scalable I/O internal unit is shown in the following illustration.

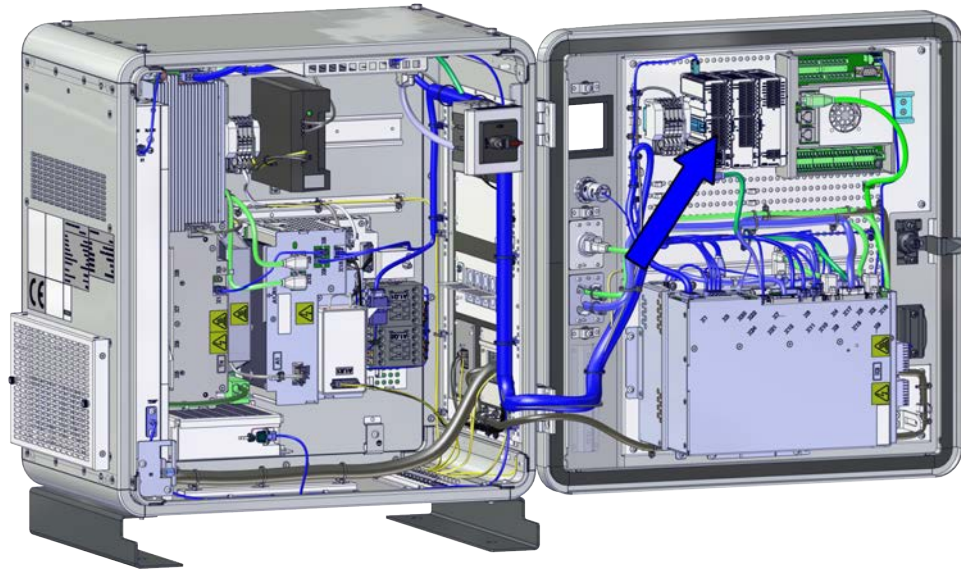

xx1900001467

The base unit can also be used as a scalable I/O external unit, with or without add-on devices.

For more information about installing, configuring, and using the scalable I/O units, see *Application manual - Scalable I/O*.

Required parts

Part	Article number	Note
Scalable I/O Digital base [3032-1]	3HAC058663-001	DSQC1030
Connectors digital base/add on	3HAC060919-001	
Digital add-on [3033-2]	3HAC058664-001	DSQC1031
Analog add-on [3034-2]	3HAC058665-001	DSQC1032
Connectors I/O Analog	3HAC060925-001	
Relay add-on [3035-2]	3HAC058666-001	DSQC1033
Connectors I/O Relay	3HAC060926-001	

Required tools and equipment

Equipment	Article number	Note
Standard toolkit	-	Content is defined in section Standard toolkit for controller on page 448 .
ESD protective wrist band	-	

Continues on next page

3 Installation and commissioning



3.7.2 Installing the scalable I/O devices

Continued

Required documents

Document	Article number	Note
<i>Circuit diagram - OmniCore C90XT</i>	<i>3HAC065464-009</i>	
<i>Application manual - Scalable I/O</i>	<i>3HAC070208-001</i>	

Installing the scalable I/O internal base device

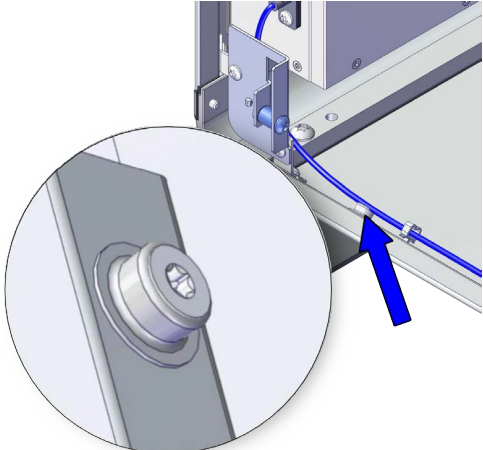
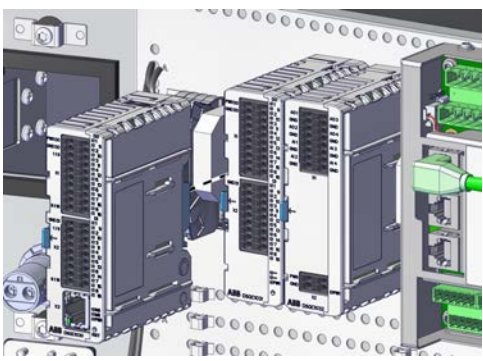
	Action	Note/Illustration
1	 DANGER Before doing any work inside the cabinet, disconnect the mains power. For more information, see Electrical safety on page 31 .	
2	 ELECTROSTATIC DISCHARGE (ESD) The unit is sensitive to ESD. Before handling the unit read the safety information in section The unit is sensitive to ESD on page 44 .	Location of wrist strap button:  xx1900001446
3	Push the digital base into the bracket until you hear a clear clicking sound.	 xx1900002447

Continues on next page

3 Installation and commissioning



3.7.2 Installing the scalable I/O devices

Continued

	Action	Note/Illustration
4	<p>Connect the adapter cable to the digital base.</p> <ul style="list-style-type: none"> K5.1.X5 - A2.X4/K4.X7 <p> Note</p> <p>If the Ethernet extension switch is installed, connect and disconnect the connector K5.1.X5 to/from K4.X7.</p> <p>If the Ethernet extension switch is not installed, connect and disconnect the connector K5.1.X5 to/from A2.X4.</p> <ul style="list-style-type: none"> K5.1.X4 - K2.X3 The harness connected to I/O unit by customer 	

Installing scalable I/O external devices

For more information about installing, configuring, and using the scalable I/O units, see *Application manual - Scalable I/O*.

	Action	Note/Illustration
1	<p> DANGER</p> <p>Before doing any work inside the cabinet, disconnect the mains power. For more information, see Electrical safety on page 31.</p>	
2	<p> ELECTROSTATIC DISCHARGE (ESD)</p> <p>The unit is sensitive to ESD. Before handling the unit read the safety information in section The unit is sensitive to ESD on page 44.</p>	
3	<p>Prepare the scalable I/O units for external mounting as described in <i>Application manual - Scalable I/O</i>.</p>	
4	<p>Open the door.</p>	<p>Opening the door on page 188.</p>
5	<p>Connect the external base device to the internal base device (X3) or the Ethernet switch, using an Ethernet cable.</p>	
6	<p>Connect an external power supply to the external base units, connector X4.</p>	<p>Each base device requires its own power supply.</p>
7	<p>Close the door.</p>	<p>Closing the door on page 188.</p>
8	<p>Perform the function tests to verify that the safety features work properly, see Function tests on page 178.</p>	

3.7.3 Installing the Ethernet extension switch

Location

The illustration shows the location of the Ethernet extension switch in the controller.

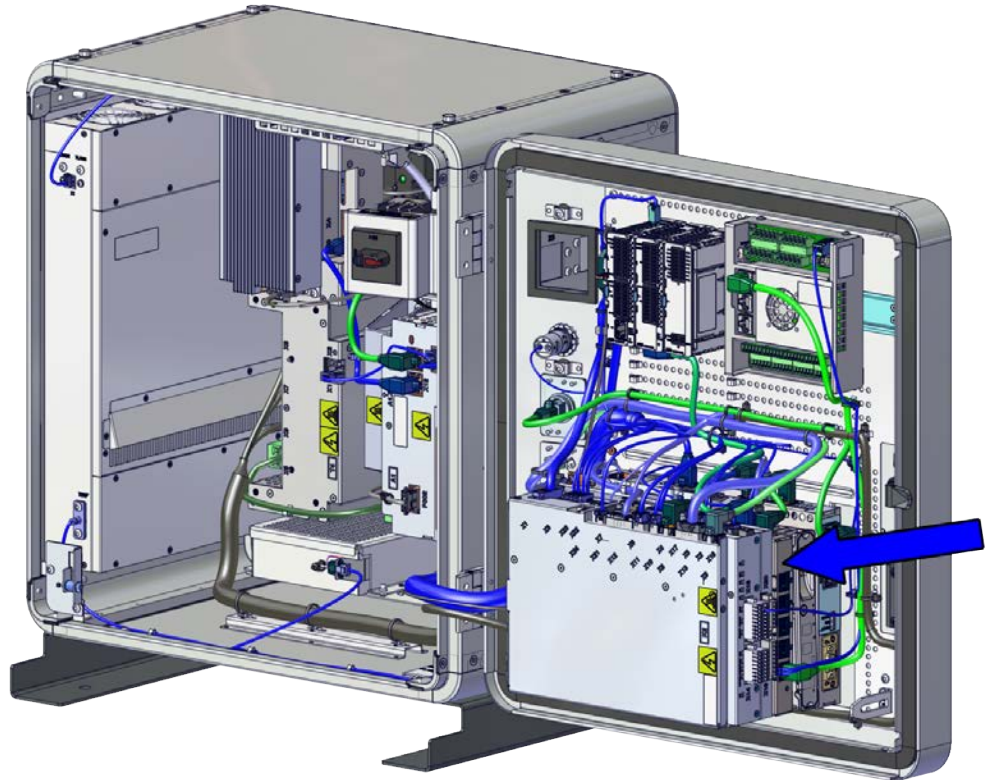

xx1900001465

Required spare parts



Note

The spare part numbers that are listed in the table can be out of date. See the latest spare parts of the OmniCore C90XT via myABB Business Portal, www.abb.com/myABB.

Spare part	Article number	Note
Ethernet Extension switch [3014-1]	3HAC059187-001	DSQC1035

Required tools and equipment

Equipment	Article number	Note
Standard toolkit	-	Content is defined in section Standard toolkit for controller on page 448 .
ESD protective wrist band	-	

Continues on next page

3 Installation and commissioning

3.7.3 Installing the Ethernet extension switch



Continued

Required documents

Document	Article number	Note
<i>Circuit diagram - OmniCore C90XT</i>	3HAC065464-009	

Installing the Ethernet extension switch

Preparations

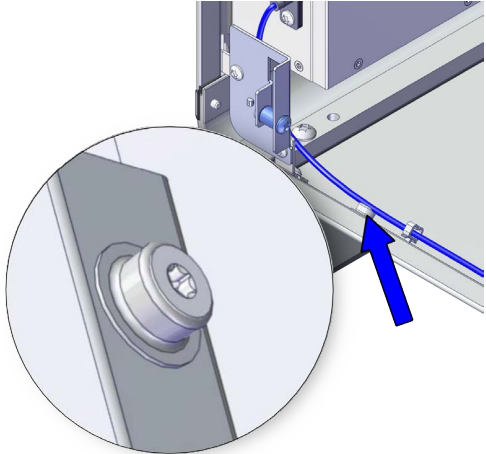
	Action	Note/Illustration
1	 DANGER Before doing any work inside the cabinet, disconnect the mains power. For more information, see Electrical safety on page 31 .	
2	Open the door.	Opening the door on page 188 .
3	 ELECTROSTATIC DISCHARGE (ESD) The unit is sensitive to ESD. Before handling the unit read the safety information in section The unit is sensitive to ESD on page 44 .	Location of wrist strap button:  <small>xx1900001446</small>

Refitting the Ethernet extension switch (option)



	Action	Note/Illustration
1	 DANGER Before doing any work inside the cabinet, disconnect the mains power. For more information, see Electrical safety on page 31 .	

Continues on next page

3 Installation and commissioning

3.7.3 Installing the Ethernet extension switch

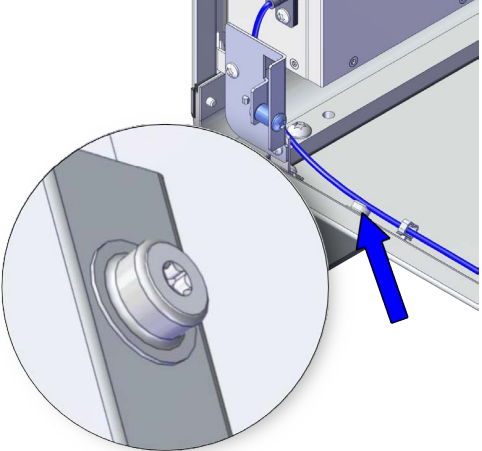
Continued

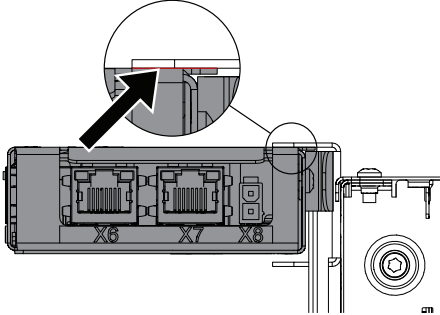
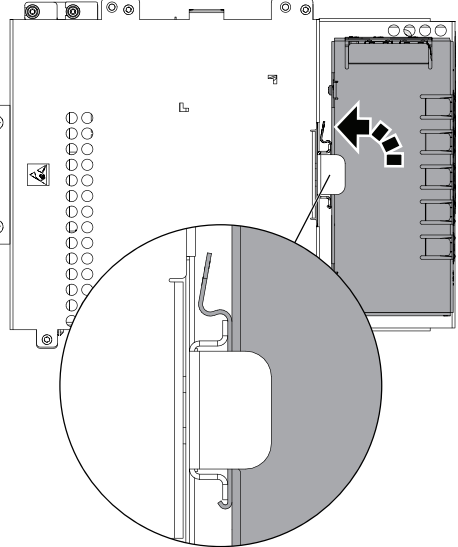
	Action	Note/Illustration
2	<p> ELECTROSTATIC DISCHARGE (ESD)</p> <p>The unit is sensitive to ESD. Before handling the unit read the safety information in section The unit is sensitive to ESD on page 44.</p>	<p>Location of wrist strap button:</p>  <p>xx1900001446</p>
3	<p>Hook up the Ethernet extension switch to the bracket and then push the switch into position.</p> <p> Note</p> <p>During the installation, there should be no gap between the upper surface of the Ethernet extension switch and the lower surface of highest bracket on the main computer.</p>  <p>xx1800000972</p>	 <p>xx1900002330</p>
4	<p>Reconnect:</p> <ul style="list-style-type: none"> • K2.X2 - K4.X8, A2.X1 • K4.X7 - K5.1.X5 • K4.X6 - A2.X4 	

Concluding procedure

	Action	Note/Illustration
1	Close the door.	Closing the door on page 188 .
2	Perform the function tests to verify that the safety features work properly, see Function tests on page 178 .	

3 Installation and commissioning

3.7.4 Installing the power supply optional device

3.7.4 Installing the power supply optional device

Location

The illustration shows the location of the power supply optional device in the controller.

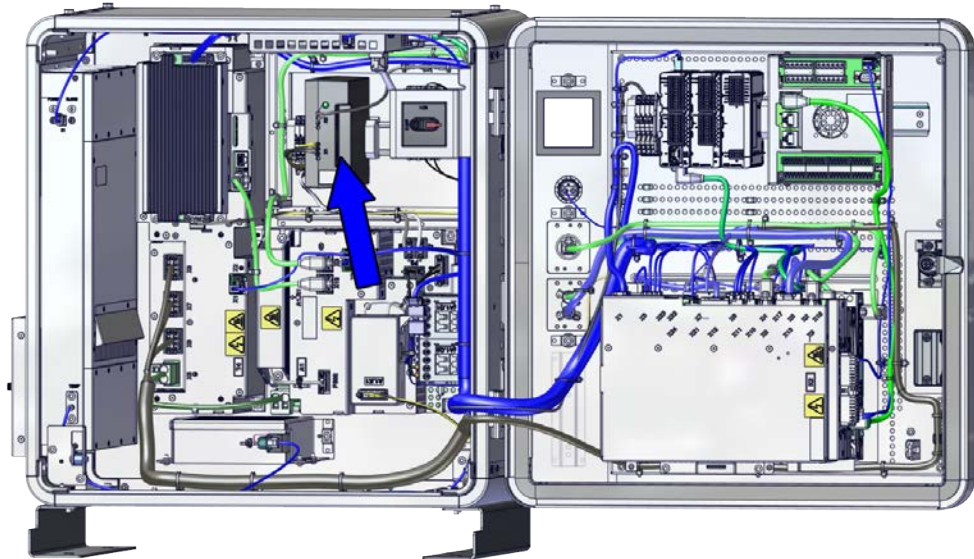

xx2000000447

Required spare parts



Note

The spare part numbers that are listed in the table can be out of date. See the latest spare parts of the OmniCore C90XT via myABB Business Portal, www.abb.com/myABB.

Spare part	Article number	Note
Power supply	3HAC071301-001	DSQC3035
DSQC 609 power supply	3HAC14178-1	DSQC 609
DSQC 634 power supply	3HAC13398-2	DSQC 634
Harness AC input of power supply	3HAC069617-001	
End clamp	3HAB7983-1	

Required tools and equipment

Equipment	Article number	Note
Standard toolkit	-	Content is defined in section Standard toolkit for controller on page 448 .
ESD protective wrist band	-	

Continues on next page

3 Installation and commissioning

3.7.4 Installing the power supply optional device



Continued

Required documents

Document	Article number	Note
<i>Circuit diagram - OmniCore C90XT</i>	<i>3HAC065464-009</i>	

Installing the optional power supply

Preparations

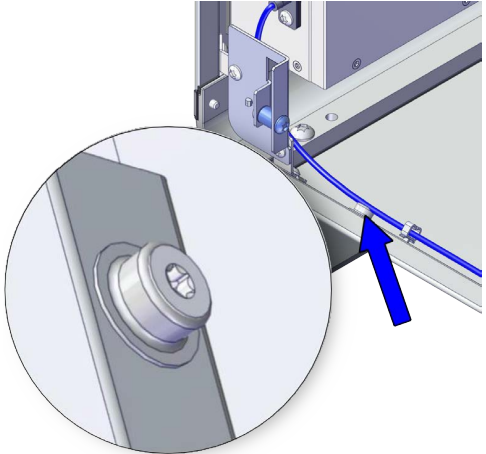
	Action	Note/Illustration
1	 DANGER Before doing any work inside the cabinet, disconnect the mains power. For more information, see Electrical safety on page 31 .	
2	Open the door.	Opening the door on page 188 .
3	 ELECTROSTATIC DISCHARGE (ESD) The unit is sensitive to ESD. Before handling the unit read the safety information in section The unit is sensitive to ESD on page 44 .	Location of wrist strap button:  xx1900001446

Installing the 24V terminal block

	Action	Note/Illustration
1	Hang the 24V terminal block to the bracket and push the lower part until you hear a clear clicking sound.	

Continues on next page

3 Installation and commissioning

3.7.4 Installing the power supply optional device

Continued

Fitting the optional power supply

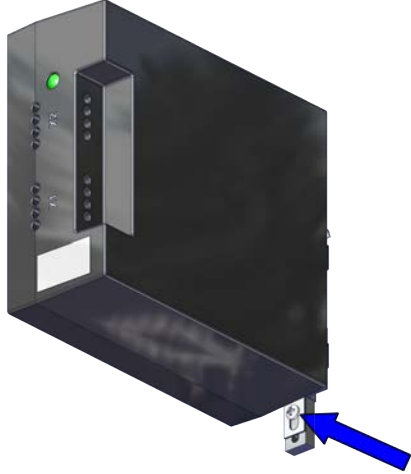
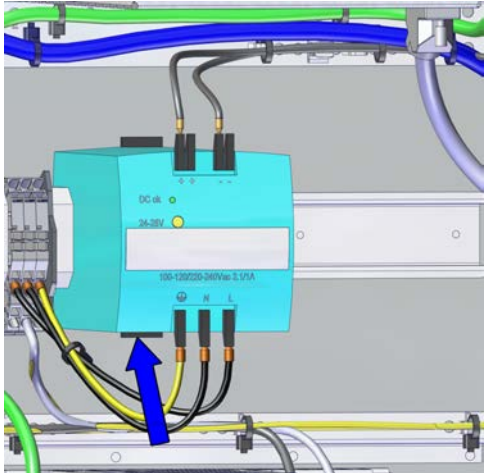

	Action	Note/Illustration
1	<p>Fit the power supply to the bracket.</p> <p> Note</p> <p>For DSQC 609: Hang the power supply to the bracket and secure the power supply with the attached screw.</p> <p>For DSQC 634: Hang the power supply to the bracket and push the lower part until you hear a clear clicking sound.</p>	<p>For DSQC 609: Screws: Cross recessed cheese head screw M4x8 (1 pcs)</p>  <p>xx1900001908</p> <p>For DSQC 634:</p>  <p>xx1900001950</p>

Continues on next page

3 Installation and commissioning

3.7.4 Installing the power supply optional device

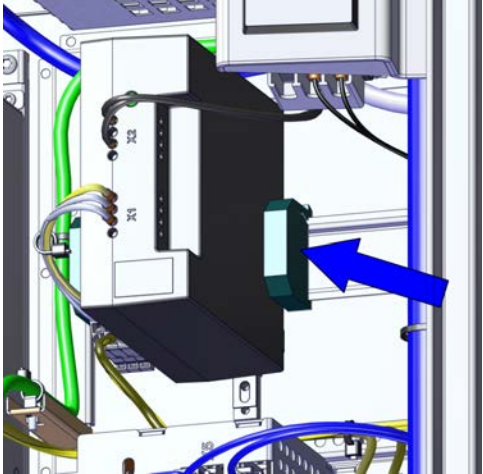
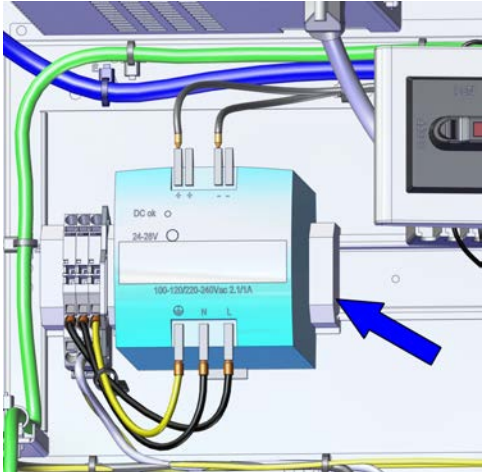
Continued

	Action	Note/Illustration
2	Refit the end clamp besides the power supply.	<p>For DSQC 609:</p>  <p>xx1900001907</p> <p>For DSQC 634:</p>  <p>xx1900002443</p>
3	Connect: <ul style="list-style-type: none"> • T5.X1-AC Terminal block • T5.X2-24V Terminal block <p> Note</p> <p>The connector on the AC_in cable (3HAC061099-001) is fastened to the cable clip in the illustration when the power supply optional is not selected.</p>	

Concluding procedure

	Action	Note/Illustration
1	Close the door.	Closing the door on page 188.
2	Perform the function tests to verify that the safety features work properly, see Function tests on page 178.	

3 Installation and commissioning

3.7.5 Installing the fieldbus adapter slave devices

3.7.5 Installing the fieldbus adapter slave devices

Location

The illustration shows the location of the fieldbus adapter slave devices in the controller.

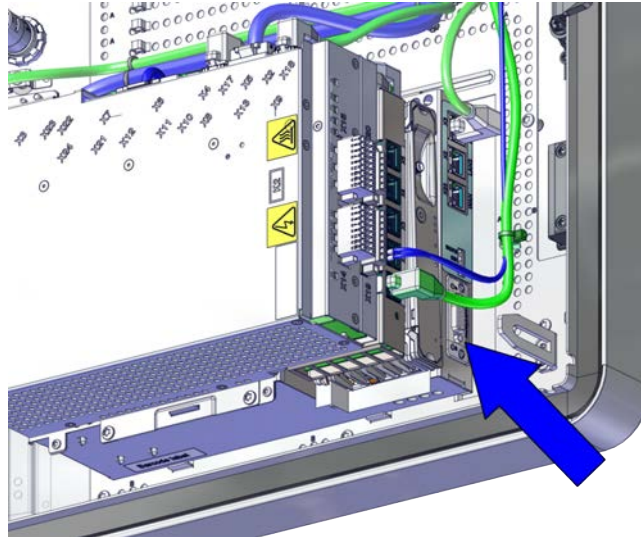

xx1900001474

Required spare parts



Note

The spare part numbers that are listed in the table can be out of date. See the latest spare parts of the OmniCore C90XT via myABB Business Portal, www.abb.com/myABB.

Spare part	Article number	Note
Fieldbus slot cover	3HAC062390-001	
DeviceNet Slave Fieldbus adaptor [3030-1]	3HAC045973-001	DSQC1004
ProfiNet Board [3022-1]	3HAC031670-001	DSQC 688
Ethernet Unit [3025-1]	3HAC027652-001	DSQC 669

Required tools and equipment

Equipment	Article number	Note
Standard toolkit	-	Content is defined in section Standard toolkit for controller on page 448 .
ESD protective wrist band	-	

Continues on next page

3 Installation and commissioning



3.7.5 Installing the fieldbus adapter slave devices

Continued

Required documents

Document	Article number	Note
<i>Circuit diagram - OmniCore C90XT</i>	<i>3HAC065464-009</i>	

Installing the fieldbus adapter slave variants

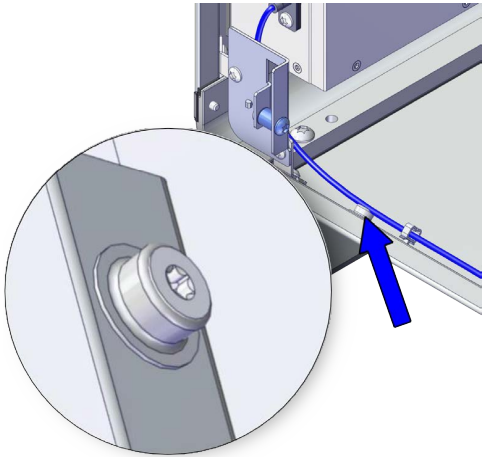
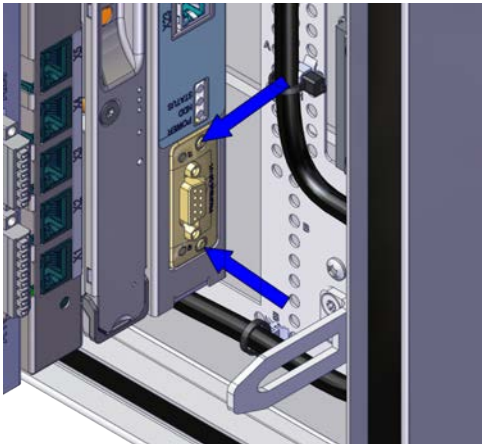
	Action	Note/Illustration
1	 DANGER Before doing any work inside the cabinet, disconnect the mains power. For more information, see Electrical safety on page 31 .	
2	 ELECTROSTATIC DISCHARGE (ESD) The unit is sensitive to ESD. Before handling the unit read the safety information in section The unit is sensitive to ESD on page 44 .	Location of wrist strap button:  <small>xx1900001446</small>
3	Open the door.	Opening the door on page 188 .
4	Remove the fieldbus slot cover with a screwdriver.	
5	Insert the fieldbus adapter slave and secure the screws.	 <small>xx1900001917</small>
6	Close the door.	Closing the door on page 188 .

Continues on next page

3 Installation and commissioning

3.7.5 Installing the fieldbus adapter slave devices

Continued

	Action	Note/Illustration
7	Perform the function tests to verify that the safety features work properly, see Function tests on page 178 .	

3.7.6 Installing the fieldbus master

Location

The illustration shows the location of the fieldbus master in the main computer.

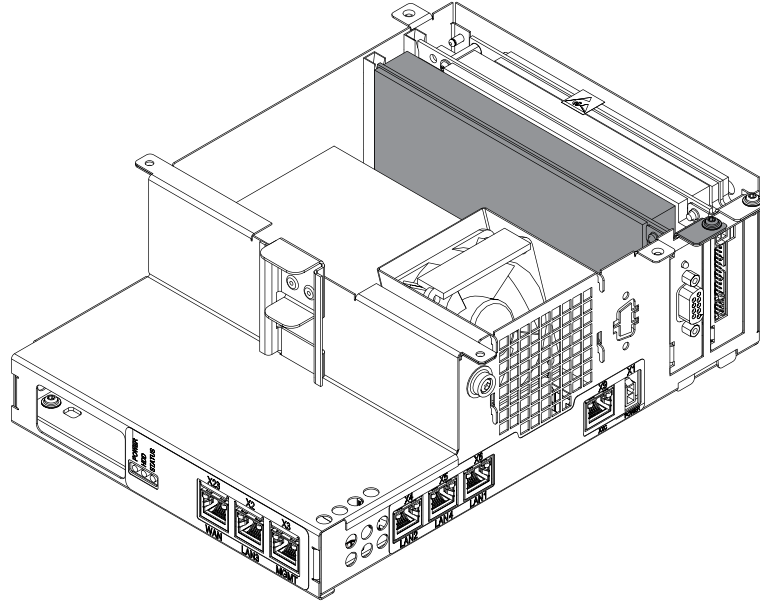

xx1800003420

Harness DeviceNet is an option of process connector.

Required spare parts



Note

The spare part numbers that are listed in the table can be out of date. See the latest spare parts of the OmniCore C90XT via myABB Business Portal, www.abb.com/myABB.

Spare part	Article number	Note
DeviceNet Board	3HAC043383-001	DSQC1006

Required tools and equipment

Equipment	Article number	Note
Standard toolkit	-	Content is defined in section Standard toolkit for controller on page 448 .
ESD protective wrist band	-	

Required documents

Document	Article number	Note
<i>Circuit diagram - OmniCore C90XT</i>	3HAC065464-009	

Continues on next page



3 Installation and commissioning

3.7.6 Installing the fieldbus master

Continued

Installing the DeviceNet board

Preparations

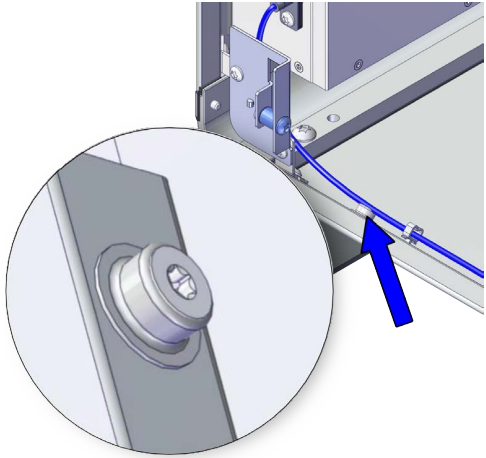
	Action	Note/Illustration
1	 DANGER Before doing any work inside the cabinet, disconnect the mains power. For more information, see Electrical safety on page 31 .	
2	Open the door.	Opening the door on page 188 .
3	 ELECTROSTATIC DISCHARGE (ESD) The unit is sensitive to ESD. Before handling the unit read the safety information in section The unit is sensitive to ESD on page 44 .	Location of wrist strap button:  xx1900001446

Removing the main computer assembly



	Action	Note/Illustration
1	Disconnect all the connectors on the assembly group of the robot signal exchange proxy, Ethernet switch (option), connected services gateway, and main computer.	
	For the robot signal exchange proxy: <ul style="list-style-type: none"> • K2.X8 - A2.X6 • (option): K2.X2 - K4.X8, A2.X1 • K2.X12 - A2.K3.X6, A2.K3.X7 • K2.X10 - A1.X13 • K2.X21 - TempSensor • K2.X4 - A1.X9 • K2.X3 - K6.X1, A2.K3.X1, K5.1.X4, K7.X1 • K2.X1 - T2.X2 • K2.X17 - G2.X1, G1.X2 • K2.X6, K2.X11 - A1.X2 • K2.X7, K2.X22 - Harn. LV robot power • K2.X9 & X13 - FlexPendant 	

Continues on next page

3 Installation and commissioning

3.7.6 Installing the fieldbus master

Continued

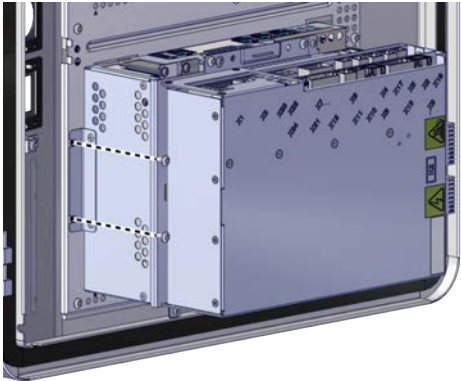

	Action	Note/Illustration
	<p>For the Ethernet extension switch (option):</p> <ul style="list-style-type: none">• K2.X2 - K4.X8, A2.X1• K4.X7 - K5.1.X5• K4.X6 - A2.X4	
	<p>For the connected services gateway:</p> <ul style="list-style-type: none">• K7.X1 - K2.X3¹• K7.X2 - A2.X5 <p> Note</p> <p>The connector K7.X2 is locked; grab the connector, push it in to release it and then remove the connector.</p>	
	<p>For the main computer:</p> <ul style="list-style-type: none">• K2.X8 - A2.X6• K2.X2 - K4.X8, A2.X1• K2.X12 - A2.K3.X6, A2.K3.X7• K6.X2 - A2.X9• A2.X5 - K7.X2• A2.X4 - K4.X6/K5.1.X5 <p> Note</p> <p>If the Ethernet extension switch is installed, connect and disconnect the connector A2.X4 to/from K4.X6.</p> <p>If the Ethernet extension switch is not installed, connect and disconnect the connector A2.X4 to/from K5.1.X5.</p>	
2	Remove the screws holding the main computer.	 <p>xx1900001877</p>

Continues on next page

3 Installation and commissioning

3.7.6 Installing the fieldbus master

Continued

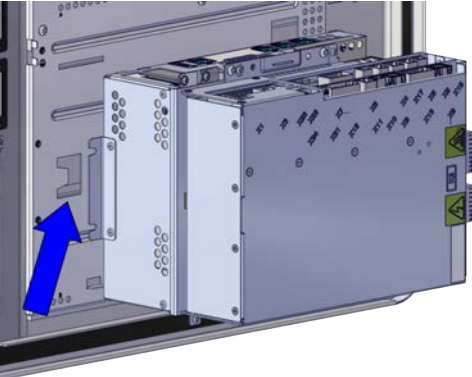
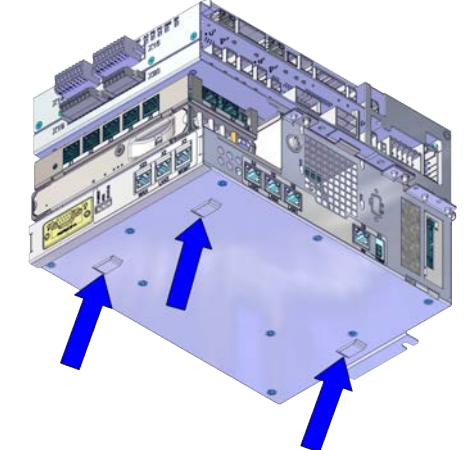
	Action	Note/Illustration
3	<p>Remove the assembly from the mounting plate.</p> <p> Note</p> <p>Avoid colliding with the frame when removing the unit.</p> <p> ELECTROSTATIC DISCHARGE (ESD)</p> <p>When handling the computer outside of the controller, use the wrist strap button located on the side of the computer.</p>	 <p>xx1900001878</p>  <p>xx1900001885</p>

i For connected services gateway wired, there is no power cable.

Removing the robot signal exchange proxy

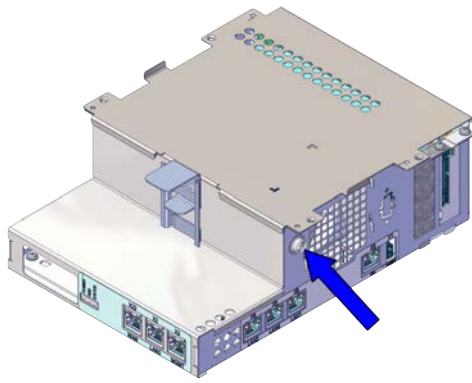
	Action	Note/Illustration
1	<p> ELECTROSTATIC DISCHARGE (ESD)</p> <p>When handling the computer outside of the controller, use the wrist strap button located on the side of the computer.</p>	<p>Location of wrist strap button:</p>  <p>xx2000000419</p>

Continues on next page

3 Installation and commissioning

3.7.6 Installing the fieldbus master

Continued

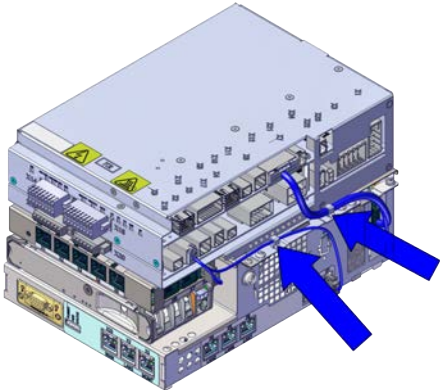
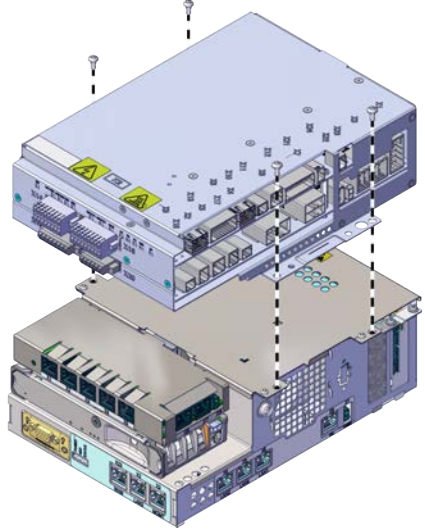
	Action	Note/Illustration
2	Pull the cable ties out from the locking holes.	 <p>xx1900001879</p>
3	Remove the screws and lift out the robot signal exchange proxy.	 <p>xx1900001880</p>

Installing the DeviceNet board

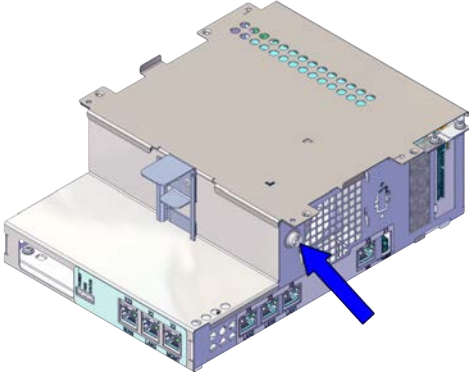



	Action	Note/Illustration
1	 <p>ELECTROSTATIC DISCHARGE (ESD)</p> <p>When handling the computer outside of the controller, use the wrist strap button located on the side of the computer.</p>	<p>Location of wrist strap button:</p>  <p>xx2000000419</p>

Continues on next page

3 Installation and commissioning

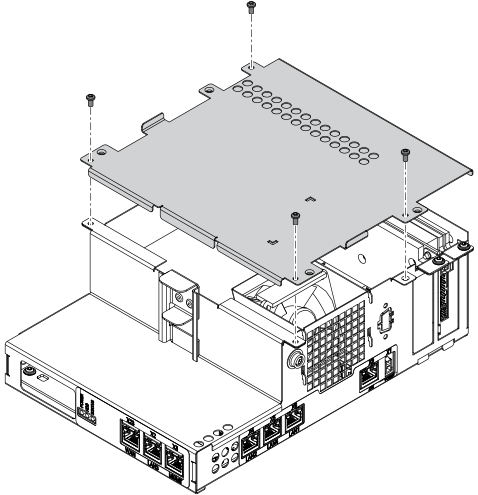
3.7.6 Installing the fieldbus master

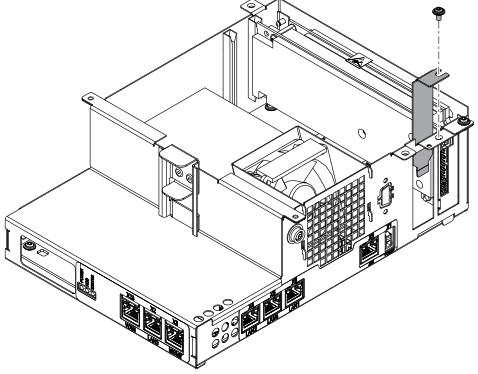
Continued





	Action	Note/Illustration
2	Remove the screws on top of the main computer and take the cover off.	 <p data-bbox="922 810 1034 833">xx1800003415</p> <p data-bbox="928 855 986 913"> Note</p> <p data-bbox="922 922 1406 1003">The Connected Services Gateway and Ethernet extension switch are omitted on the illustration to make it more clear.</p>
3	Remove the attachment screw on the cover of the fieldbus master and take out the cover.	 <p data-bbox="922 1415 1034 1438">xx1800003414</p> <p data-bbox="928 1460 986 1518"> Note</p> <p data-bbox="922 1527 1406 1608">The Connected Services Gateway and Ethernet extension switch are omitted on the illustration to make it more clear.</p>

Continues on next page

3 Installation and commissioning

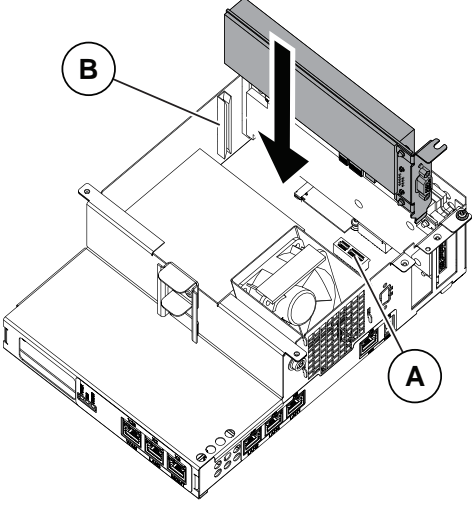
3.7.6 Installing the fieldbus master

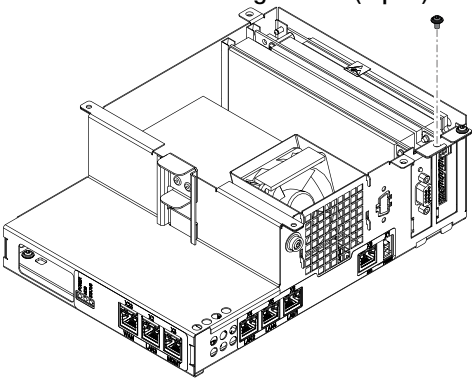
Continued



	Action	Note/Illustration				
4	<p>Insert the DeviceNet board into the card slots along the guide rail in the main computer.</p>	 <p>xx1800003417</p> <table border="1" data-bbox="954 862 1428 952"> <tr> <td>A</td> <td>Card slots</td> </tr> <tr> <td>B</td> <td>Guide rail</td> </tr> </table> <p> Note</p> <p>The Connected Services Gateway and Ethernet extension switch are omitted on the illustration to make it more clear.</p>	A	Card slots	B	Guide rail
A	Card slots					
B	Guide rail					
5	<p>Secure the DeviceNet board with the screw.</p>	<p>Screw: Screw with flange M3x6 (1 pcs)</p>  <p>xx1800003416</p> <p> Note</p> <p>The Connected Services Gateway and Ethernet extension switch are omitted on the illustration to make it more clear.</p>				

Continues on next page

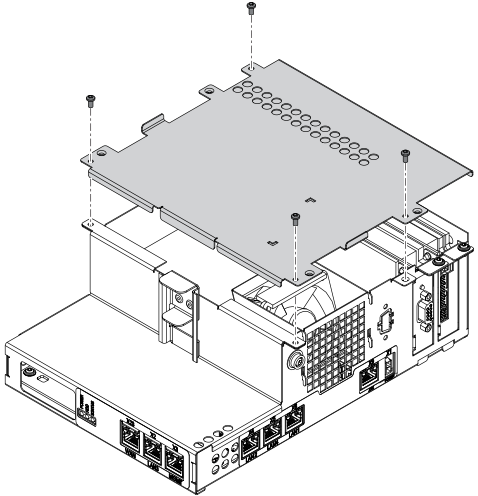

3 Installation and commissioning

3.7.6 Installing the fieldbus master

Continued

	Action	Note/Illustration
6	Refit the cover on the main computer and secure the screws.	<p>Screws: Hexalobular socket pan head screw M3x6 (4 pcs)</p>  <p>xx1800003418</p> <p> Note</p> <p>The Connected Services Gateway and Ethernet extension switch are omitted on the illustration to make it more clear.</p>

Refitting the robot signal exchange proxy

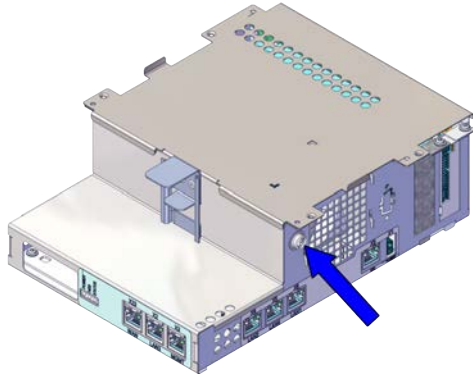
	Action	Note/Illustration
1	<p> DANGER</p> <p>Before doing any work inside the cabinet, disconnect the mains power. For more information, see Electrical safety on page 31.</p>	
2	<p> ELECTROSTATIC DISCHARGE (ESD)</p> <p>The unit is sensitive to ESD. Before handling the unit read the safety information in section The unit is sensitive to ESD on page 44.</p>	<p>Location of wrist strap button:</p>  <p>xx2000000419</p>

Continues on next page

3 Installation and commissioning

3.7.6 Installing the fieldbus master

Continued

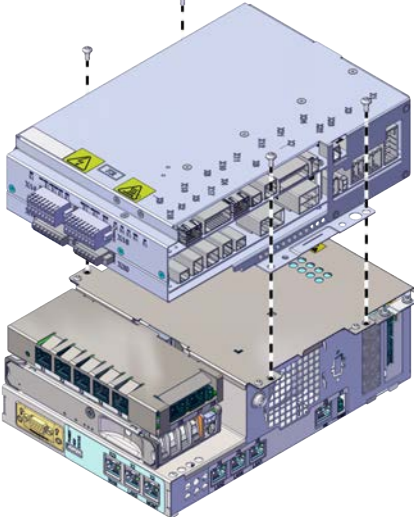
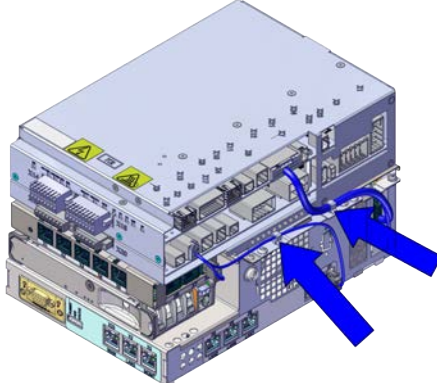
	Action	Note/Illustration
3	Fit the robot signal exchange proxy and secure the screws.	<p>Screws: Torx pan head screw M4x8 (4 pcs) Tightening torque: 1.7 Nm±10%.</p>  <p>xx1900001880</p>
4	Insert the cable ties into the locking holes.	 <p>xx1900001879</p>

Refitting the main computer assembly to the cabinet

	Action	Note/Illustration
1	 <p>DANGER</p> <p>Before doing any work inside the cabinet, disconnect the mains power. For more information, see Electrical safety on page 31.</p>	

Continues on next page

3 Installation and commissioning

3.7.6 Installing the fieldbus master

Continued

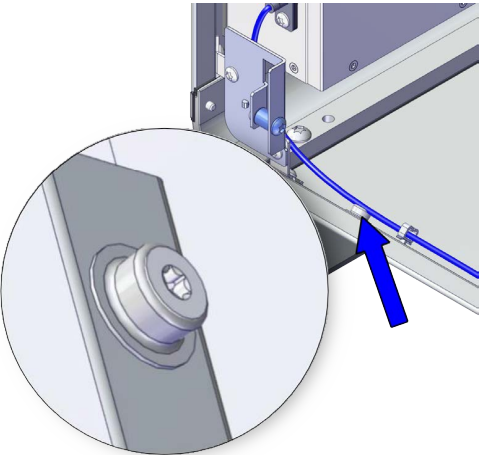
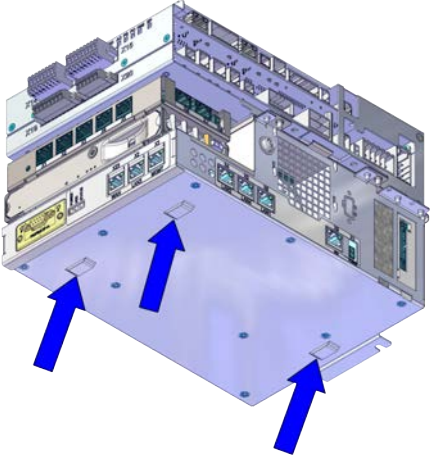
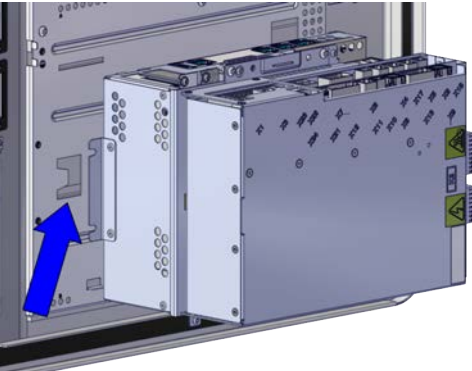

	Action	Note/Illustration
2	<p> ELECTROSTATIC DISCHARGE (ESD)</p> <p>When handling the computer outside of the controller, use the wrist strap button located on the side of the computer.</p>	<p>Location of wrist strap button:</p>  <p>xx1900001446</p>
3	<p>Refit the assembly onto the mounting plate.</p>	 <p>xx1900001885</p>  <p>xx1900001878</p>

Continues on next page

3 Installation and commissioning

3.7.6 Installing the fieldbus master

Continued

	Action	Note/Illustration
4	Fasten the assembly with the screws.	 <p>xx1900001877</p>
5	<p>Reconnect all the connectors on assembly of the robot signal exchange proxy, ethernet extension-seven port switch (option), ABB ability™ connected services, and main computer.</p> <p>For the robot signal exchange proxy:</p> <ul style="list-style-type: none"> • K2.X8 - A2.X6 • (option): K2.X2 - K4.X8, A2.X1 • K2.X12 - A2.K3.X6, A2.K3.X7 • K2.X10 - A1.X13 • K2.X21 - TempSensor (G3.TEMP) • K2.X4 - A1.X9 • K2.X3 - K6.X1, A2.K3.X1, K5.1.X4, K7.X1 • K2.X1 - T2.X2 • K2.X17 - G3.X1, G1.X2 • K2.X6, K2.X11 - A1.X2 • K2.X7, K2.X22 - Harn. LV robot power (X1) • K2.X9 & X13 - FlexPendant (X4) <p>For the Ethernet extension switch (option):</p> <ul style="list-style-type: none"> • K2.X2 - K4.X8, A2.X1 • K4.X7 - K5.1.X5 • K4.X6 - A2.X4 	
	<p>For the connected services gateway:</p> <ul style="list-style-type: none"> • K7.X1 - K2.X3ⁱ • K7.X2 - A2.X5 <p> Note</p> <p>The connector K7.X2 is locked; grab the connector, push it in to release it and then remove the connector.</p>	

Continues on next page

3 Installation and commissioning

3.7.6 Installing the fieldbus master

Continued

Action	Note/Illustration
<p>For the main computer:</p> <ul style="list-style-type: none">• A2.X3 - X24• K2.X8 - A2.X6• K2.X2 - K4.X8, A2.X1• K2.X12 - A2.K3.X6, A2.K3.X7• K6.X2 - A2.X9• A2.X5 - K7.X2• A2.X4 - K4.X6/K5.1.X5 <p> Note</p> <p>If the Ethernet extension switch is installed, connect and disconnect the connector A2.X4 to/from K4.X6.</p> <p>If the Ethernet extension switch is not installed, connect and disconnect the connector A2.X4 to/from K5.1.X5.</p>	

ⁱ For connected services gateway wired, there is no power cable.

Concluding procedure

	Action	Note/Illustration
1	Close the door.	Closing the door on page 188.
2	Perform the function tests to verify that the safety features work properly, see Function tests on page 178.	

3.7.7 Installing the conveyor tracking module

Overview

The conveyor tracking module uses network communication to share conveyor speed and position data with one or more robot controllers. It contains a WAN port, which is used to connect to the robot controllers and two LAN ports that can be used for installation and service purposes.

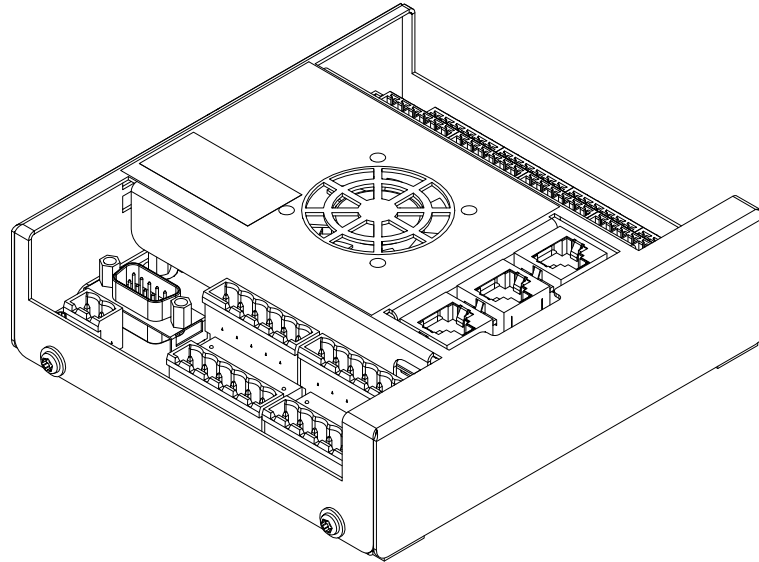

xx180000941

Required parts



Note

The spare part numbers that are listed in the table can be out of date. See the latest spare parts of the OmniCore C90XT via myABB Business Portal, www.abb.com/myABB.

Spare part	Article number	Note
Conveyor tracking module [3103-1]	3HNA027579-001	DSQC2000
CONNECTOR KIT - DSQC2000	3HNA029345-001	

Required tools and equipment

Equipment	Article number	Note
Standard toolkit	-	Content is defined in section Standard toolkit for controller on page 448 .
ESD protective wrist band	-	

Continues on next page

3 Installation and commissioning



3.7.7 Installing the conveyor tracking module

Continued

Required documents

Document	Article number	Note
<i>Circuit diagram - OmniCore C90XT</i>	<i>3HAC065464-009</i>	
<i>Application manual - Conveyor tracking</i>	<i>3HAC066561-001</i>	

Installing the conveyor tracking module

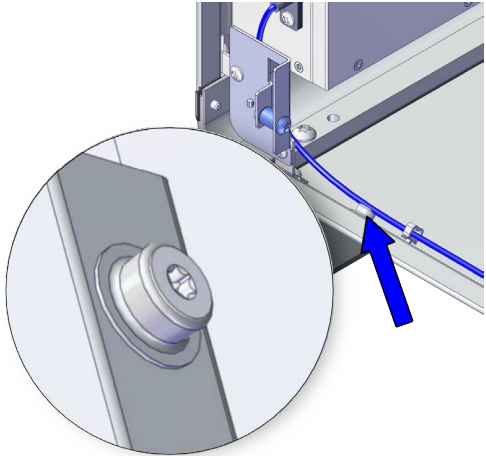
	Action	Note/Illustration
1	 DANGER Before doing any work inside the cabinet, disconnect the mains power. For more information, see Electrical safety on page 31 .	
2	 ELECTROSTATIC DISCHARGE (ESD) The unit is sensitive to ESD. Before handling the unit read the safety information in section The unit is sensitive to ESD on page 44 .	Location of wrist strap button:  xx1900001446
3	Open the door.	Opening the door on page 188 .

Continues on next page

3 Installation and commissioning

3.7.7 Installing the conveyor tracking module

Continued

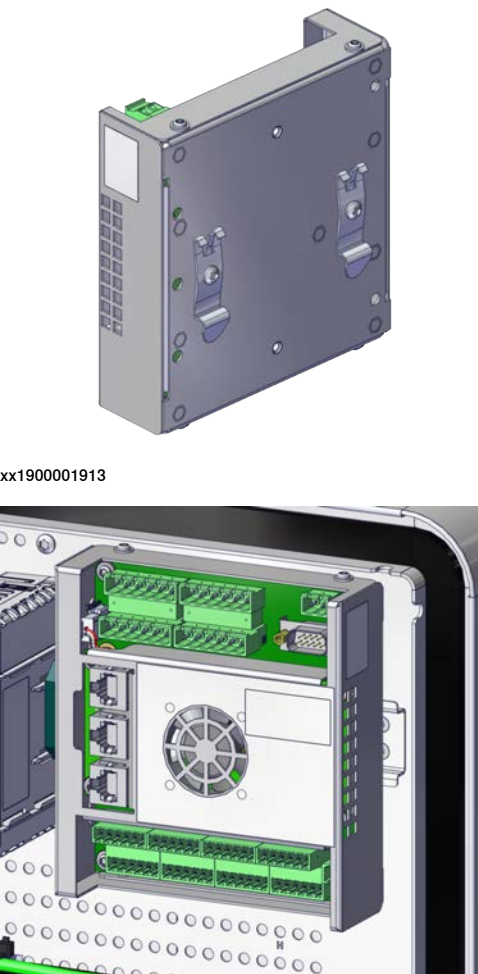
	Action	Note/Illustration
4	Fit the conveyor tracking module and push the lower part until you hear a clear clicking sound.	 <p>The illustration shows the conveyor tracking module (xx1900001913) being inserted into the chassis (xx1900001912). The module is a grey rectangular unit with a green connector on top. The chassis is a larger grey unit with a fan and various connectors. The module is shown being pushed into the chassis, with the lower part of the module being inserted into a slot.</p>
5	Connect: <ul style="list-style-type: none"> • B1.X1 - K2.X19.1, K2.X19.2 (Power cable) • B1.X7 - K4.X1-5 (Ethernet cable) 	
6	Connect wires to the input and output connectors as required.	See <i>Application manual - Conveyor tracking</i> .
7	Close the door.	Closing the door on page 188.
8	Perform the function tests to verify that the safety features work properly, see Function tests on page 178.	

For more information about the option *Conveyor Tracking*, see *Application manual - Conveyor tracking*.

3 Installation and commissioning

3.7.8 Installing the cable grommet assembly

3.7.8 Installing the cable grommet assembly

Location

The illustration shows the location of the cable grommet assembly on the controller.



xx1900001480



Note

The end user need to buy proper grommets according to the diameter of the cables which need to go through the grommet. This will affect the protection level of the cabinet if it's not executed correctly. It is recommended to use icotek KT grommet.

Required spare parts



Note

The spare part numbers that are listed in the table can be out of date. See the latest spare parts of the OmniCore C90XT via myABB Business Portal, www.abb.com/myABB.

Spare part	Article number	Note
Cable grommet asm	3HAC066396-001	

Continues on next page

3 Installation and commissioning

3.7.8 Installing the cable grommet assembly

Continued

Required tools and equipment



Equipment	Article number	Note
Standard toolkit	-	Content is defined in section Standard toolkit for controller on page 448 .
ESD protective wrist band	-	

Required documents

Document	Article number	Note
<i>Circuit diagram - OmniCore C90XT</i>	3HAC065464-009	

Installing cables with the cable grommet assembly

Preparations

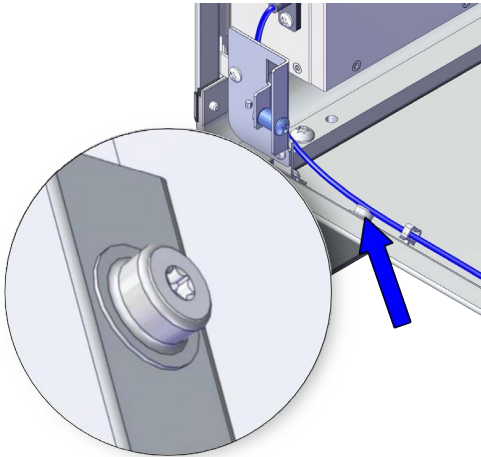
	Action	Note/Illustration
1	 DANGER Before doing any work inside the cabinet, disconnect the mains power. For more information, see Electrical safety on page 31 .	
2	Open the door.	Opening the door on page 188 .
3	 ELECTROSTATIC DISCHARGE (ESD) The unit is sensitive to ESD. Before handling the unit read the safety information in section The unit is sensitive to ESD on page 44 .	Location of wrist strap button:  xx1900001446

Continues on next page

3 Installation and commissioning

3.7.8 Installing the cable grommet assembly

Continued

Removing the slot cover (baseline)

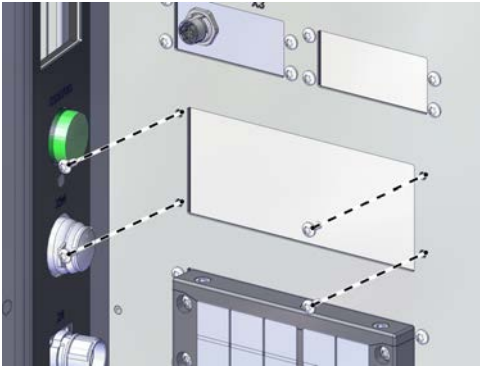
	Action	Note/Illustration
1	Remove the attachment screws.	 <p>xx1900002444</p>
2	Take out the cover from the inside of the controller.	

Refitting the cable grommet assembly

Refitting the cables to the cable grommet assembly



	Action	Note/Illustration
1	Insert and equip the cable to the corresponding KT grommet.	 <p>xx1900002337</p>

Continues on next page

3 Installation and commissioning

3.7.8 Installing the cable grommet assembly

Continued

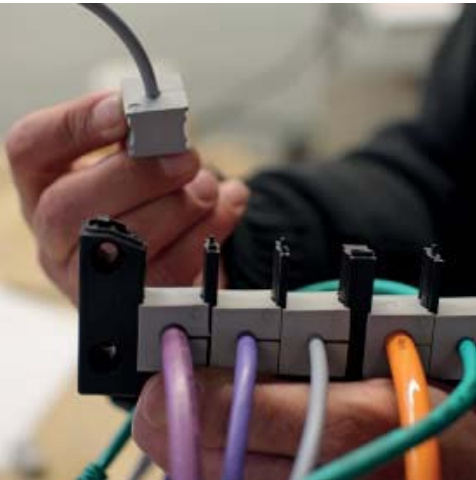
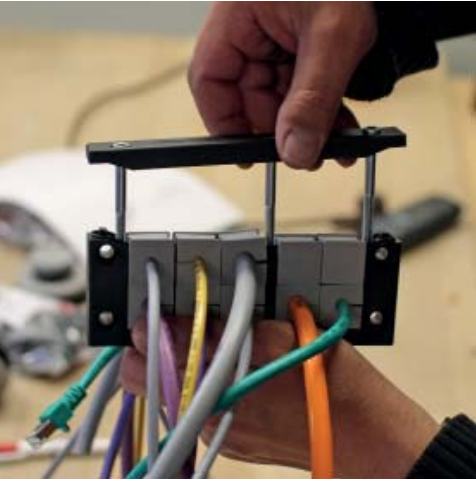
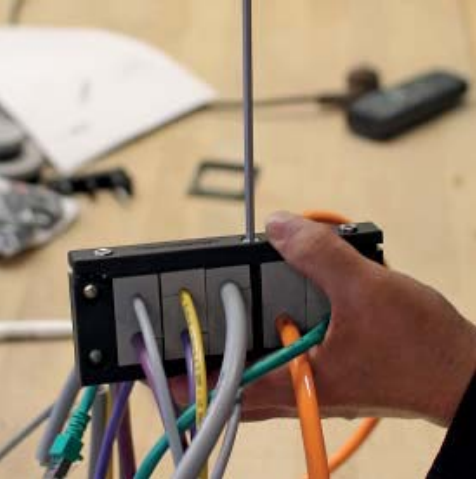

	Action	Note/Illustration
2	<p>Slide the grommets into the frame halves.</p> <p> Note</p> <p>It must be ensured that the flat side of the grommets in the lower row are pointing to the open side of the frame half (flat sides pointing upwards).</p> <p> Note</p> <p>The flat side of the grommets in the upper row have to point downwards so that all flat sides rest on each other. When using single row frames the flat side has to point towards the cover strip.</p>	 <p>xx1900002336</p>
3	<p>Refit the cover strip onto the frame.</p>	 <p>xx1900002335</p>
4	<p>Secure the frame and cover strip with the screws.</p>	<p>Screws: Hex socket head cap screw M5x50 12.9 Lafre 2C2B/FC6.9 (3 pcs) Tightening torque: 2 Nm - 3 Nm.</p>  <p>xx1900002334</p>

Continues on next page

3 Installation and commissioning

3.7.8 Installing the cable grommet assembly

Continued

	Action	Note/Illustration
5	Route the cables through the cut-out.	 <p>xx1900002333</p>
6	Refit the cable entry frame to the enclosure wall and secure with the screws.	<p>Screws: Torx pan head screw M4x8 (4 pcs) Tightening torque: 1.5 Nm.</p>  <p>xx1900002332</p>

Refitting the cable grommet assembly

	Action	Note/Illustration
1	 <p>DANGER</p> <p>Before doing any work inside the cabinet, disconnect the mains power. For more information, see Electrical safety on page 31.</p>	

Continues on next page

3 Installation and commissioning

3.7.8 Installing the cable grommet assembly

Continued

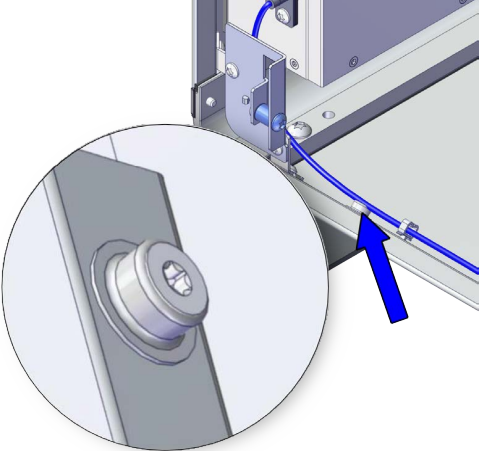
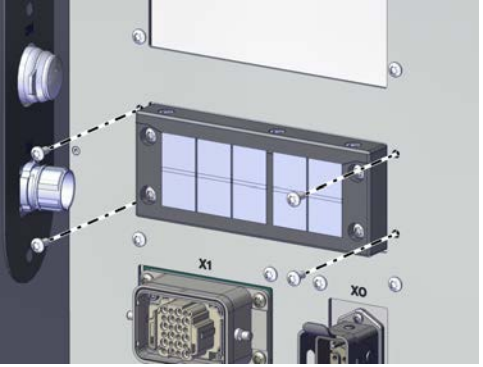
	Action	Note/Illustration
2	<p> ELECTROSTATIC DISCHARGE (ESD)</p> <p>The unit is sensitive to ESD. Before handling the unit read the safety information in section The unit is sensitive to ESD on page 44.</p>	<p>Location of wrist strap button:</p>  <p>xx1900001446</p>
3	<p>Insert the cable grommet assembly into the cover of the cabinet. Secure it with the screws.</p>	<p>Screws: Torx pan head screw M4x8 (4 pcs)</p>  <p>xx1900002340</p>

Concluding procedure

	Action	Note/Illustration
1	Close the door.	Closing the door on page 188 .
2	Perform the function tests to verify that the safety features work properly, see Function tests on page 178 .	

3 Installation and commissioning

3.7.9 Installing the filter

3.7.9 Installing the filter

Location

The illustration shows the location of the air filter on the controller.

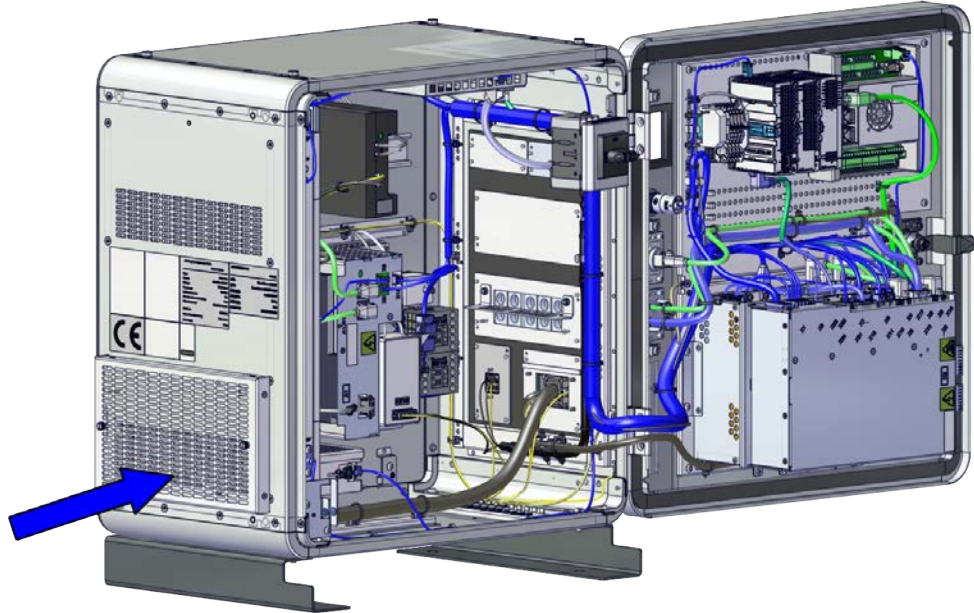

xx1900001473

Required spare parts



Note

The spare part numbers that are listed in the table can be out of date. See the latest spare parts of the OmniCore C90XT via myABB Business Portal, www.abb.com/myABB.

Spare part	Article number	Note
Air filter-coarse filter	3HAC068415-001	
Air filter-Fine filter	3HAC068416-001	
Air filter (Polymeric)	3HAC068543-001	Filter element of fine filter

Required tools and equipment



Equipment	Article number	Note
Standard toolkit	-	Content is defined in section Standard toolkit for controller on page 448 .
ESD protective wrist band	-	

Continues on next page

Required documents

Document	Article number	Note
Circuit diagram - OmniCore C90XT	3HAC065464-009	

Installing the air filter

	Action	Note/Illustration
1	 DANGER Before doing any work inside the cabinet, disconnect the mains power. For more information, see Electrical safety on page 31 .	
2	Fit the air filter to the cabinet. Secure it with the screws.	 <p>xx1900001492</p>
3	Perform the function tests to verify that the safety features work properly, see Function tests on page 178 .	

3 Installation and commissioning

3.8.1 Installing the extension box

3.8 Installing add-on devices

3.8.1 Installing the extension box

General

As an option an empty extension box can be purchased, to use for custom equipment. The extension box can be installed on the basic box or anywhere else as a standalone equipment.



xx1900001453



Note

Connect PE19 as grounding for the extension box in any use case.

Required equipment

Equipment	Information
Standard toolkit	See Standard toolkit for controller on page 448 .

Continues on next page

Specifications

It is recommended to use multicore cable for the customer connection.

The following describes the cable requirements for the X106 connection in the extension box.

Component	Description
Cable type	Flexible oil resistant rubber
Cable area	4C x 0.5 mm ² or AWG20

Included parts

The following parts are included in the delivery when the extension box is selected.

Part	Order number	Quantity
Connector for X106	3HAC074661-001	1

Procedure

Use this procedure to stack an extension box to a basic box.

	Action	Info/illustration
1	Place the controller in desired place.	
2	Fix the basic box to a concrete foundation or steel platform with anchor bolts.	Anchor bolts: M8 X 4 Tighten torque: 11.3 Nm-12.6 Nm
3	Remove the four plastic screw.	 <p>xx1900001450</p>

Continues on next page

3 Installation and commissioning

3.8.1 Installing the extension box

Continued

	Action	Info/illustration
4	Assemble the hexalobular socket pan head screws onto the cabinet.	 <p>xx1900001451</p>
5	Place the extension box upright the basic box with lifting accessory. Lock them with screws.	 <p>xx1900001452</p>
6	Open the door of the extension box.	Opening the door on page 188.

Continues on next page

3 Installation and commissioning

3.8.1 Installing the extension box

Continued

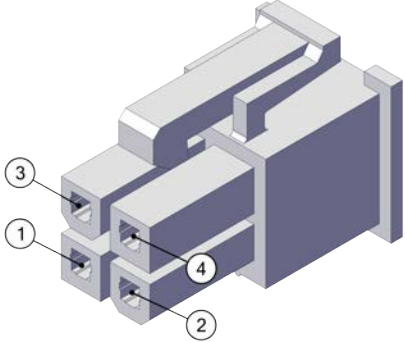
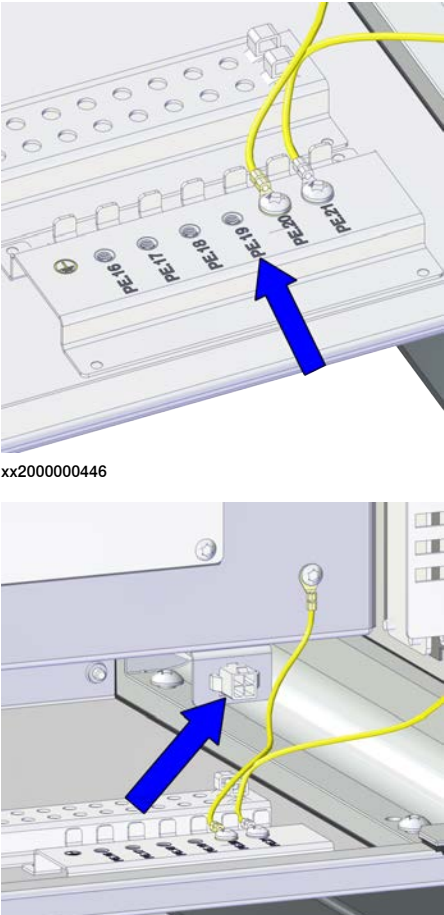
	Action	Info/illustration
7	Fit the connector (3HAC074661-001) for X106.	 <p>xx2000000690</p> <ul style="list-style-type: none">1 24 V2 0 V3 24 V4 0 V
8	Connect through the cable grommet: <ul style="list-style-type: none">• PE19• X106	<p>How to insert cable through cable grommet, see Releasing the cables from the cable grommet assembly on page 342 and Refitting the cables to the cable grommet assembly on page 345.</p>  <p>xx2000000446</p> <p>xx2000000689</p>

Continues on next page

3 Installation and commissioning

3.8.1 Installing the extension box

Continued

	Action	Info/illustration
9	<p>Install the equipment to the extension box according to your requirements.</p> <p> WARNING</p> <p>ABB only offers the extension box as an encapsulation for customer installing external devices.</p> <p>It is the system builder's responsibly to ensure the complacence with electrical safety, for example the Low Voltage Directive.</p>	

3.8.2 Installing the conveyor tracking module to extension box

Overview

The conveyor tracking module uses network communication to share conveyor speed and position data with one or more robot controllers. It contains a WAN port, which is used to connect to the robot controllers and two LAN ports that can be used for installation and service purposes.

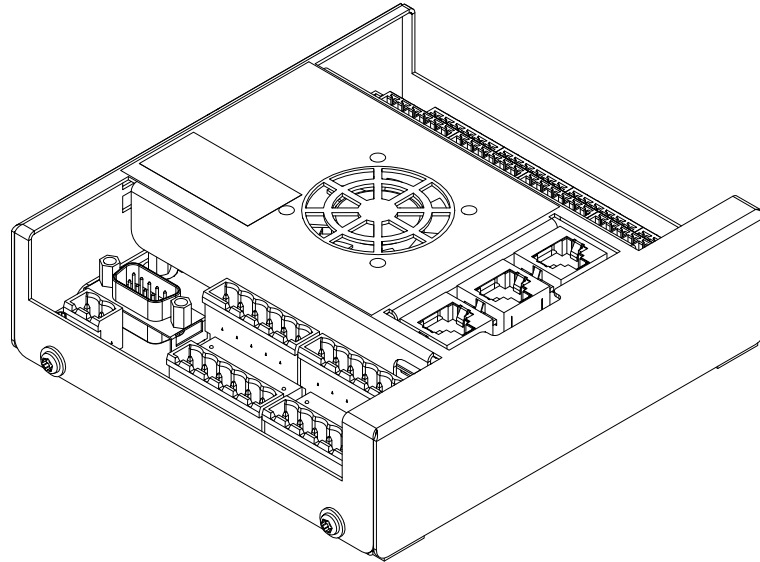

xx180000941

Required parts



Note

The spare part numbers that are listed in the table can be out of date. See the latest spare parts of the OmniCore C90XT via myABB Business Portal, www.abb.com/myABB.

Spare part	Article number	Note
Conveyor tracking module [3103-1]	3HNA027579-001	DSQC2000
CONNECTOR KIT - DSQC2000	3HNA029345-001	

Required tools and equipment

Equipment	Article number	Note
Standard toolkit	-	Content is defined in section Standard toolkit for controller on page 448 .
ESD protective wrist band	-	

Continues on next page

3 Installation and commissioning



3.8.2 Installing the conveyor tracking module to extension box

Continued

Required documents

Document	Article number	Note
Circuit diagram - OmniCore C90XT	3HAC065464-009	
Application manual - Conveyor tracking	3HAC066561-001	

Installing the conveyor tracking module

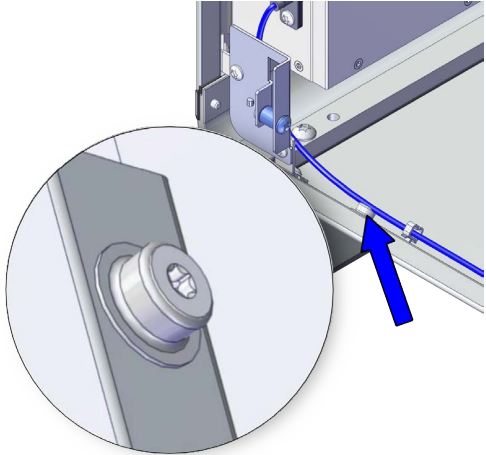
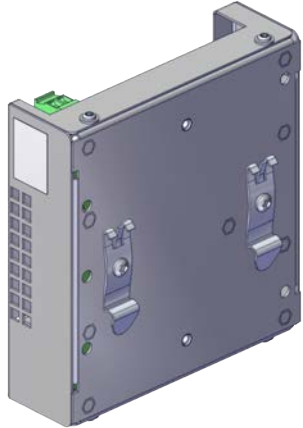
	Action	Note/Illustration
1	 DANGER Before doing any work inside the cabinet, disconnect the mains power. For more information, see Electrical safety on page 31 .	
2	 ELECTROSTATIC DISCHARGE (ESD) The unit is sensitive to ESD. Before handling the unit read the safety information in section The unit is sensitive to ESD on page 44 .	Location of wrist strap button:  xx1900001446
3	Open the door of the extension box.	Opening the door on page 188 .
4	Fit the conveyor tracking module by snapping it onto the mounting rail .	 xx1900001913

Continues on next page

3 Installation and commissioning

3.8.2 Installing the conveyor tracking module to extension box

Continued

	Action	Note/Illustration
5	Connect the 24V power supply to the conveyor tracking module from the basic box or other power supply.	How to insert cable through cable grommet, see Releasing the cables from the cable grommet assembly on page 342 and Refitting the cables to the cable grommet assembly on page 345 .
6	Connected to Ethernet through the cable grommet: <ul style="list-style-type: none">• B1.X7 - K4.X1-5	For details on connecting wires to the conveyor tracking module, see <i>Application manual - Conveyor tracking</i> .
7	Connect wires to the input and output connectors as required.	
8	Close the door.	Closing the door on page 188 .
9	Perform the function tests to verify that the safety features work properly, see Function tests on page 178 .	

For more information about the option *Conveyor Tracking*, see *Application manual - Conveyor tracking*.

3 Installation and commissioning

3.9 Installing external devices

3.9 Installing external devices

General



WARNING

Only LVD³ equipments can be installed on the door of the controller.



WARNING

ABB only offers the extension box as an encapsulation for customer installing external devices.

It is the system builder's responsibly to ensure the complacence with electrical safety, for example the Low Voltage Directive.

³ Low Voltage Directive

3.10 Initial test before commissioning

Protective earth

Before supplying power to the robot and commissioning, verify that the cabinet is connected to protective earth according to [Connecting incoming mains and protective earth to the controller on page 83](#).

Function tests

Before commissioning, perform the function tests in section [Function tests on page 178](#) to verify that the safety features work properly.

This page is intentionally left blank

4 Maintenance

4.1 Maintenance schedule for the OmniCore controller

General

The controller must be maintained at regular intervals to ensure its function. The activities and intervals are described in this section.

Activities and intervals

Equipment	Maintenance activity	Interval	Detailed in section:
Complete controller	Inspection	12 months ⁱ	Inspecting the OmniCore C90XT controller on page 169
Air filter	Cleaning		Cleaning air filter on page 170
Air filter	Replacement	24 months	Replacement of air filter on page 175
System fans	Inspection	6 months ⁱ	Inspecting the OmniCore C90XT controller on page 169
Control cabinet	Cleaning		Cleaning of the controller cabinet on page 172
FlexPendant	Cleaning	When needed	Cleaning the FlexPendant on page 173
Emergency stop (FlexPendant)	Function test	12 months	Function test of emergency stop on page 178
Manual, auto and manual full speed mode with FlexPendant	Function test	12 months	Function test of manual, auto, and manual full speed mode with FlexPendant on page 179
Enabling device	Function test	12 months	Function test of three-position enabling device on page 180
Safety switches	Function test	12 months	Function test of safety switches on page 181
Auto stop (tested if used)	Function test	12 months	Function test of Automatic Stop on page 182
General stop (tested if used)	Function test	12 months	Function test of General Stop on page 183
External emergency stop (tested if used)	Function test	12 months	Function test of external emergency stop on page 184
ESTOP_STATUS output (tested if used)	Function test	12 months	Function test of ESTOP_STATUS output on page 185
Reduced speed control	Function test	During commissioning	Function test of reduced speed control on page 186.

ⁱ The interval depends on the working environment of the equipment: a cleaner environment may extend the maintenance interval and vice versa.

Continues on next page

4 Maintenance

4.1 Maintenance schedule for the OmniCore controller

Continued



Function test after replacement of component

After replacing a component in the controller, the function tests should be performed. See [Function tests on page 178](#).

4.2 Inspection activities

4.2.1 Inspection of controller

Inspecting the OmniCore C90XT controller

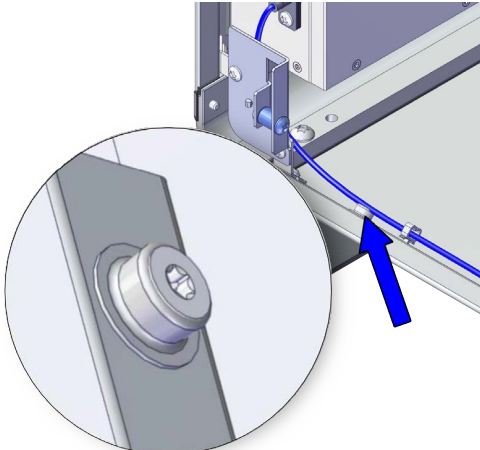
	Action	Note/illustration
1	 <p>DANGER</p> <p>Before doing any work inside the cabinet, disconnect the mains power. For more information, see Electrical safety on page 31.</p>	
2	 <p>ELECTROSTATIC DISCHARGE (ESD)</p> <p>The unit is sensitive to ESD. Before handling the unit read the safety information in section The unit is sensitive to ESD on page 44.</p>	<p>Location of wrist strap button:</p>  <p>xx1900001446</p>
3	<p>Inspect connectors and cabling to make sure they are securely fastened and cabling not damaged.</p>	
4	<p>Inspect the fans and ventilation holes to make sure they are clean.</p>	
5	<p>After inspection: Temporarily turn the power supply on. Inspect the fans to make sure they function correctly. Switch the power off.</p>	

4 Maintenance

4.3.1 Cleaning air filter

4.3 Cleaning activities

4.3.1 Cleaning air filter

Location

The air filter is located as shown in the illustration below.

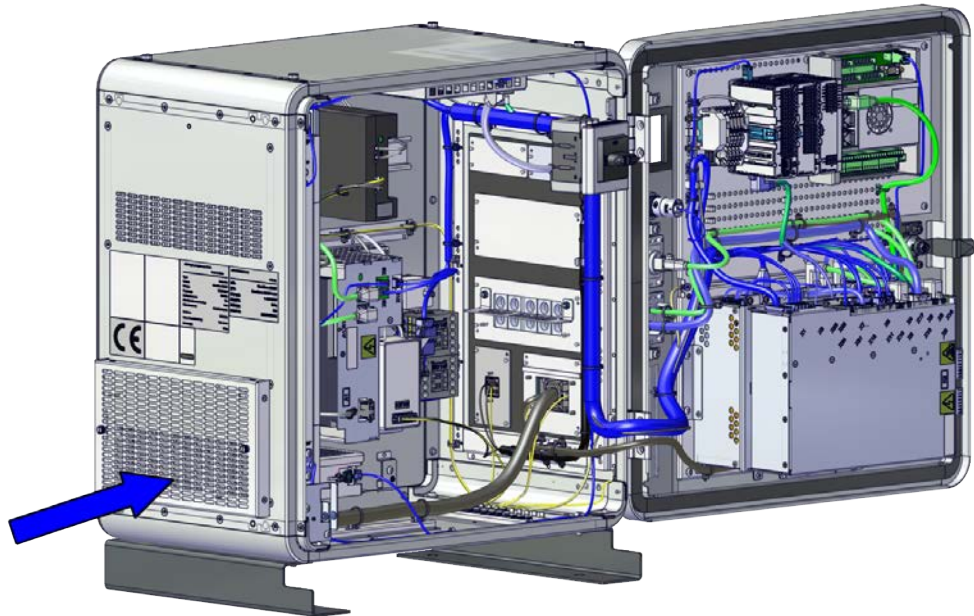

xx1900001473

Required equipment

Equipment	Note
Cleaning agent	Water 30-40 °C with cleansing liquid or detergent.
Compressed air	

Cleaning

The procedure below details how to clean the moist dust filter.

	Action	Note/Illustration
1	Remove the air filter.	How to remove the air filter is detailed in section Replacing the air filter on page 311 .
2	If a fine filter is used, remove the polymeric filter element first.	
3	Clean the filter three or four times.	
4	Allow the filter to dry in one of these ways: <ul style="list-style-type: none">• Lying flat on a flat surface• Blow with compressed air in opposite direction of filter airflow.	 Note Do not wring the filter to press out water.
5	If a fine filter is used, refit a new polymeric filter element to the filter.	

Continues on next page

	Action	Note/Illustration
6	Refit the air filter.	

4 Maintenance

4.3.2 Cleaning of the controller cabinet

4.3.2 Cleaning of the controller cabinet

Required equipment

Equipment, etc.	Note
Vacuum cleaner	ESD protected

Cleaning considerations

This section specifies some special considerations when cleaning the controller.

- Always use ESD protection.
- Always use cleaning equipment as specified above. Any other cleaning equipment may shorten the life of paint work, rust inhibitors, signs, or labels.
- Always make sure that all protective covers are fitted to the controller before cleaning.
- Never remove any covers or other protective devices when cleaning the outside of the controller.
- Never use compressed air or spray with a high pressure cleaner.
- Never leave the door open when cleaning the exterior.

4.3.3 Cleaning the FlexPendant

Location

The surfaces to clean are shown in the illustration below.

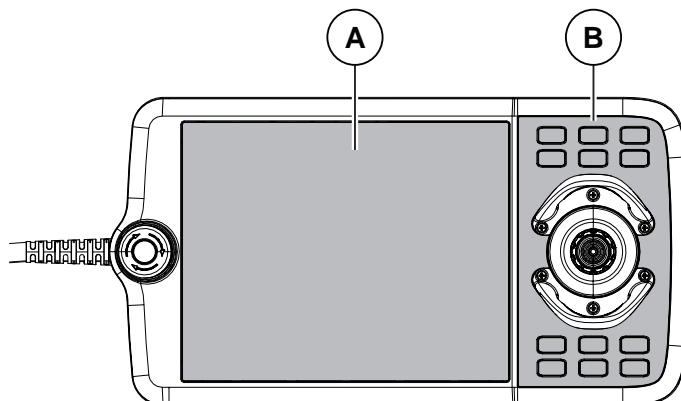

xx180000128

A	Touch screen
B	Hard buttons

Required equipment

Equipment, etc.	Note
Soft cloth	ESD protected
Water/Mild cleaning agent	

Clean the touch screen

This section describes how to clean the touch screen.

	Action	Info/Illustration
1	Lock the screen.	
2	It is safe to clean the FlexPendant when the Lock screen appears.	
3	Clean the touch screen and hardware buttons using a soft cloth and water or a mild cleaning agent.	
4	Unlock the screen, by tapping the buttons.	

Cleaning considerations

The section below specifies some special considerations when cleaning the FlexPendant:

- Use ESD Protection
- Use cleaning equipment as specified above. Any other cleaning equipment may shorten the life time of the touch screen.
- Check that all protective covers are fitted to the device before cleaning.
- Make sure that no foreign objects or liquids can penetrate into the device.

Continues on next page

4 Maintenance

4.3.3 Cleaning the FlexPendant

Continued

- Do not remove any covers before cleaning the FlexPendant.
- Do not spray with a high pressure cleaner.
- Do not clean the device, operating panel and operating elements with compressed air, solvents, scouring agent or scrubbing sponges.

4.4 Changing/replacing activities

4.4.1 Replacement of air filter

Location

The air filter is located as shown in the illustration below.

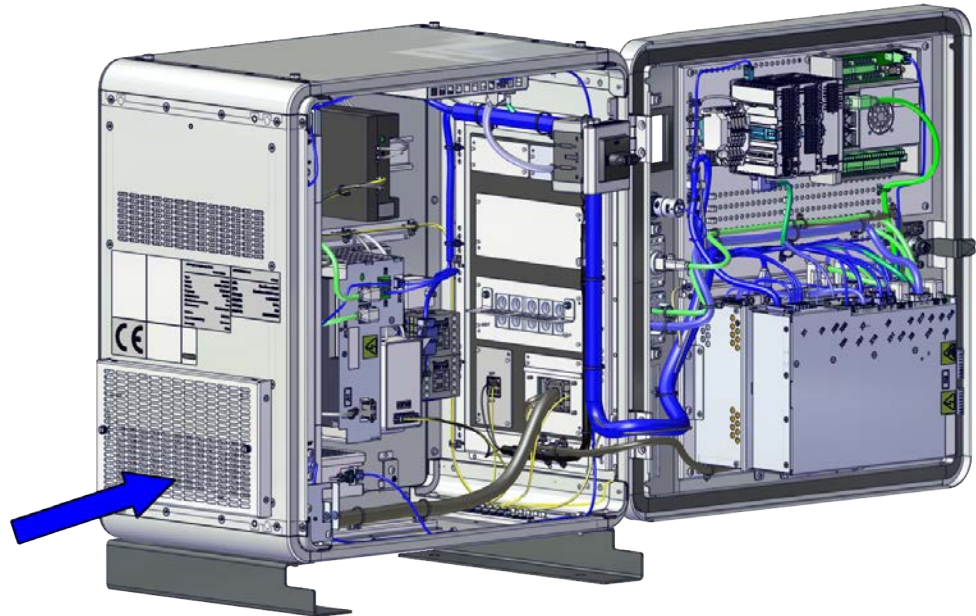

xx1900001473

Required equipment

Equipment	Note
Air filter	
Other tools and procedures may be required. See references to these procedures in the step-by-step instructions below.	These procedures include references to the tools required.

Removing the air filter

Preparations

	Action	Note/Illustration
1	 DANGER Before doing any work inside the cabinet, disconnect the mains power. For more information, see Electrical safety on page 31 .	



Continues on next page

4 Maintenance

4.4.1 Replacement of air filter

Continued

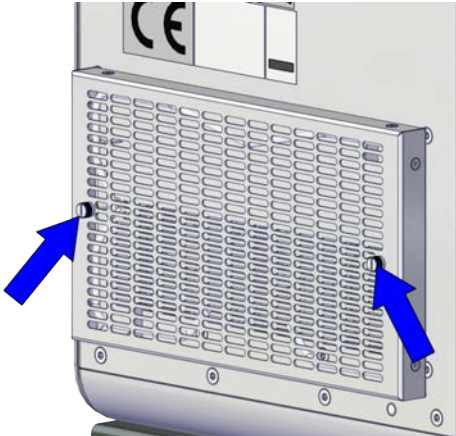
Removing the air filter

	Action	Note/Illustration
1	Loosen the attachment screws on the air filter.	 <p>xx1900001491</p>
2	Remove the air filter unit.	 <p>xx1900001492</p>

Removing the polymeric filter element

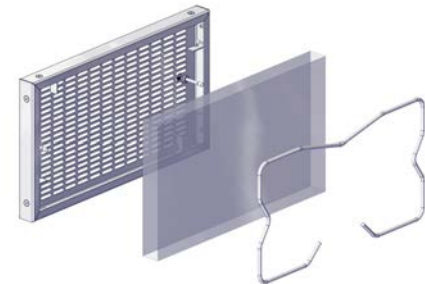
	Action	Note/Illustration
1	Take out the polymeric filter element from the filter.	 <p>xx2000000421</p>



Continues on next page

Refitting the air filter

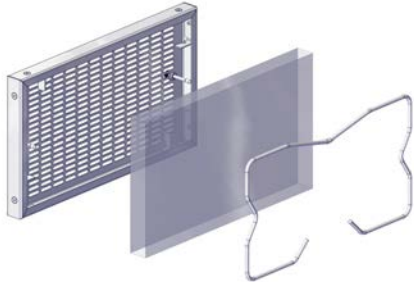
Refitting the polymeric filter element

	Action	Note/Illustration
1	Insert the polymeric filter element to the filter and secure with the metallic line.	 <p>xx2000000421</p>

Refitting the air filter

	Action	Note/Illustration
1	 DANGER Before doing any work inside the cabinet, disconnect the mains power. For more information, see Electrical safety on page 31 .	
2	Refit the air filter unit to the cabinet.	
3	Secure it with the screws.	 <p>xx1900001492</p>

Concluding procedure

	Action	Note/Illustration
1	Perform the function tests to verify that the safety features work properly, see Function tests on page 178 .	

4 Maintenance

4.5.1 Function test of emergency stop

4.5 Function tests

4.5.1 Function test of emergency stop

Overview



Validate the function of the FlexPendant emergency stop device.



Note

Also perform the test for any additional emergency stop devices.

Performing the function test

	Action	Note
1	Make a visual inspection of the emergency stop device to make sure it is not physically damaged.	If any damage is found on the emergency stop device, it must be replaced.
2	Pull and rotate the emergency stop device clockwise to verify that it is not pressed in.	
3	Power on the robot.	
4	<p>Press the emergency stop device on the FlexPendant.</p>  Note If the event message 20223 Emergency stop conflict appears in the event log, or the event message 10013 Emergency stop state (and 90518 Safety controller Emergency stop triggered for robots prepared for collaborative applications) does not appear, then the test has failed and the root cause of the failure must be found.	<p>The test is passed if the event message 10013 Emergency stop state appears in the event log.</p> <p>If either of the following happens, then the test is failed and the root cause must be found:</p> <ul style="list-style-type: none">• if the event message 10013 Emergency stop state does not appear• if the event message 90780 Two-channel fault in Safety Controller appears  Note For robots prepared for collaborative applications, the event message 90518 Safety controller Emergency stop triggered appears by default. The message 10013 Emergency stop state is also available in the event log.
5	Release the emergency stop device to reset the emergency stop state.	

4.5.2 Function test of manual, auto, and manual full speed mode with FlexPendant

Overview

Perform this function test to change the mode on the FlexPendant using the following operation:

- **Status bar > Common Settings > Operating Mode (Auto/Manual/Man FS).**

For more detailed information, see *Operating manual - OmniCore, 3HAC065036-001*.

Performing the function test

	Action	Note
1	Start the robot system.	
2	Change to Automatic operating mode and Motors ON state, and then run the robot in auto mode.	This test is passed if it is possible to run the robot program in auto mode. If it is not possible to run the robot program, this test is failed and the root cause of the failure must be found.
3	Change to Manual operating mode and Motors ON state, and then run the robot in manual mode.	This test is passed if it is possible to run the robot program in manual mode. If it is not possible to run the robot program, this test is failed and the root cause of the failure must be found.
4	Change to Manual Full Speed mode and Motors ON state, and then run the robot in manual full speed mode.  Note Manual full speed mode is not available in USA or Canada.	This test is passed if it is possible to run the robot program in manual full speed mode. If it is not possible to run the robot program, this test is failed and the root cause of the failure must be found.

4 Maintenance

4.5.3 Function test of three-position enabling device

4.5.3 Function test of three-position enabling device

Performing the function test

	Action	Note
1	Start the robot system and turn the mode switch to manual mode.	
2	Press the three-position enabling device to the middle position and then hold the enabling device in this position.	This test is passed if the event message 10011 Motors ON state appears in the event log. If either of the following happens, then the test is failed and the root cause must be found: <ul style="list-style-type: none">• if the event message 10011 Motors ON state does not appear• if the event message 90780 Two-channel fault in Safety Controller appears
3	While still holding the three-position enabling device pressed, press the enabling device harder to the enable the device's third position.	This test is passed if the event message 10012 Safety guard stop state appears in the event log. If either of the following happens, then the test is failed and the root cause must be found: <ul style="list-style-type: none">• if the event message 10012 Safety guard stop state does not appear• if the event message 90780 Two-channel fault in Safety Controller appears

4.5.4 Function test of safety switches

Performing the motor function test

	Action	Note
1	Start the robot system and change the operating mode to manual.	
2	Press the three-position enabling device to the middle position and then hold the enabling device in this position.	This test is passed if the event message 10011 Motors ON state appears in the event log. If the event message 37001 Motor on activation error appears in the event log, then the test has failed and the root cause of the failure must be found.
3	Release the three-position enabling device.	This test is passed if the event message 10012 Safety guard stop state appears in the event log. If the event message 90227 Motor contact or conflict appears in the event log, then the test has failed and the root cause of the failure must be found.

Performing the brake function test

	Action	Note
1	Start the robot system and change the operating mode to manual.	
2	Press the three-position enabling device to the middle position and then hold the enabling device in this position. While having eye contact with the manipulator, move the joystick slightly in any direction to disengage the brakes.	This test is passed if the brakes are disengaged and the manipulator can be moved. If the event message 50056 Joint collision appears in the event log, then the test has failed and the root cause of the failure must be found.
3	Release the three-position enabling device to engage the brakes.	This test is passed if the event message 10012 Safety guard stop state appears in the event log. If the event message 37101 Brake Failure appears in the event log, then the test has failed and the root cause of the failure must be found.

4 Maintenance

4.5.5 Function test of Automatic Stop

4.5.5 Function test of Automatic Stop

Performing the function test

	Action	Note
1	Start the robot system and change the operating mode to auto mode.	
2	Activate the Automatic Stop, for example by opening the connected robot cell door, which has interlock connection with Automatic Stop.	<p>The test is passed if the event message 90523 Safety Controller Protective Stop triggered appears in the event log.</p> <p>If either of the following happens, then the test is failed and the root cause must be found:</p> <ul style="list-style-type: none">• if the event message 90523 Safety Controller Protective Stop triggered does not appear• if the event message 90780 Two-channel fault in Safety Controller appears

4.5.6 Function test of General Stop

Performing the function test

	Action	Note
1	Start the robot system.	
2	Activate the General Stop.	<p>The test is passed if the event message 90523 Safety Controller Protective Stop triggered appears in the event log.</p> <p>If either of the following happens, then the test is failed and the root cause must be found:</p> <ul style="list-style-type: none">• if the event message 90523 Safety Controller Protective Stop triggered does not appear• if the event message 90780 Two-channel fault in Safety Controller appears

4 Maintenance



4.5.7 Function test of external emergency stop

4.5.7 Function test of external emergency stop

Overview

Perform this test on the external emergency stop device.

Performing the function test



	Action	Note
1	Make a visual inspection of the external emergency stop device and the connection harness to make sure they are not physically damaged.	If any damage is found on the external emergency stop device or the connection harness, it must be replaced.
2	<p>Pull and rotate the button on the external emergency stop device clockwise to verify that it is not pressed in.</p> <p> Note</p> <p>If the external emergency stop device is not controlled by a push-button, make sure to verify that it is not activated.</p>	
3	Start the robot system.	
4	Press the emergency stop device.	<p>The test is passed if the event message 10013 Emergency stop state appears in the event log.</p> <p>If the event message 90780 Two-channel fault in Safety Controller appears in the event log, or the event message 10013 Emergency stop state does not appear, then the test has failed and the root cause of the failure must be found.</p> <p> Note</p> <p>The event message 90518 Safety controller Emergency stop triggered appears by default.</p>
5	Release the external emergency stop device to reset the external emergency stop state.	

4.5.8 Function test of ESTOP_STATUS output

Overview

Perform this test on the FlexPendant emergency stop device or the external emergency stop device, with the accessory device.

Performing the function test

	Action	Note
1	Make a visual inspection of the emergency stop device, external emergency stop device, accessory device and the connection harness to make sure they are not physically damaged.	If any damage is found, it must be replaced.
2	Pull and rotate the emergency stop device clockwise to verify that it is not pressed in.  Note If the external emergency stop device is not controlled by a push-button, make sure to verify that it is not activated.	
3	Start the robot system.	
4	Press the emergency stop device.	The test is passed if the event message 10013 Emergency stop state appears in the event log. If the event message 90780 Two-channel fault in Safety Controller appears in the event log, or the event message 10013 Emergency stop state does not appear, then the test has failed and the root cause of the failure must be found.  Note The event message 90518 Safety controller Emergency stop triggered appears by default.
5	Make sure that the accessory device is in emergency stop status.	
6	Release the emergency stop device or the external emergency stop device to reset the emergency stop state.	
7	Make sure that the accessory device is not in emergency stop status any more and can be reset.	

4 Maintenance

4.5.9 Function test of reduced speed control

4.5.9 Function test of reduced speed control

Performing the function test

	Action	Note
1	Start the robot system and change the operating mode to manual.	
2	Create a test program where the robot moves along a known distance with a programmed speed higher than 250 mm/s.	The distance and speed must be adapted to the current installation and robot model.
3	<p>Start the program in manual mode and measure the time it takes for the robot to travel the distance.</p> <p> Tip</p> <p>To get accurate results, use sensors or I/O signals to measure the time.</p>	This test is passed if the speed of the robot does not exceed 250 mm/s, otherwise the test is failed and the root cause of the failure must be found.

5 Repair

5.1 Introduction to repair

Structure of this chapter

This chapter describes all repair activities recommended for the OmniCore C90XT and any external unit.

It is made up of separate procedures, each describing a specific repair activity. Each procedure contains all the information required to perform the activity, for example spare parts numbers, required special tools, and materials.

All procedures assume that the controller is easy to access from all sides and that no additional covers or equipment are fitted.



WARNING

Repair activities not described in this chapter must only be carried out by ABB. Otherwise damage to the mechanics and electronics may occur.

Required equipment

The details of the equipment required to perform a specific repair activity are listed in the respective procedures.

Safety information

Read chapter [Safety on page 15](#) before commencing any service work.



WARNING

Wait at least three minutes after powering off the controller before opening it and at least fifteen minutes until all LED indicators are off before replacing modules. Allow the surfaces to cool down before maintenance or repair.



Note

When replacing a part on the OmniCore C90XT, report to your local ABB the serial number, the article number, and the revision of both the replaced unit and the replacement unit.

This is particularly important for safety equipment to maintain the safety integrity of the installation.

5 Repair

5.2.1 Opening the robot controller

5.2 Replacement of controller parts

5.2.1 Opening the robot controller

Required tools and equipment

Equipment	Article number	Note
Standard toolkit	-	Content is defined in section Standard toolkit for controller on page 448 .
ESD protective wrist band	-	

Required documents

Document	Article number	Note
<i>Circuit diagram - OmniCore C90XT</i>	3HAC065464-009	

Opening the door

Preparations

	Action	Info/illustration
1	 DANGER Before doing any work inside the cabinet, disconnect the mains power. For more information, see Electrical safety on page 31 .	

Opening the door

	Action	Info/illustration
1	Insert the key to the door and turn it anti-clockwise.	
2	Pull out the handle and turn it anti-clockwise.	
3	Pull out the door with the handle.	
	 Tip Use the door stop to lock the door position before maintenance is started.	

Closing the door

Closing the door

	Action	Info/illustration
	If door stop has been used during maintenance, place the door stop in its original position.	

Continues on next page

	Action	Info/illustration
1	Push the door back.	
2	Turn the handle clockwise and push it back into the lock.	
3	Turn the key back and take it out.	

5 Repair

5.2.2 Replacing the axis computer

5.2.2 Replacing the axis computer

Location

The illustration shows the location of the axis computer in the controller.

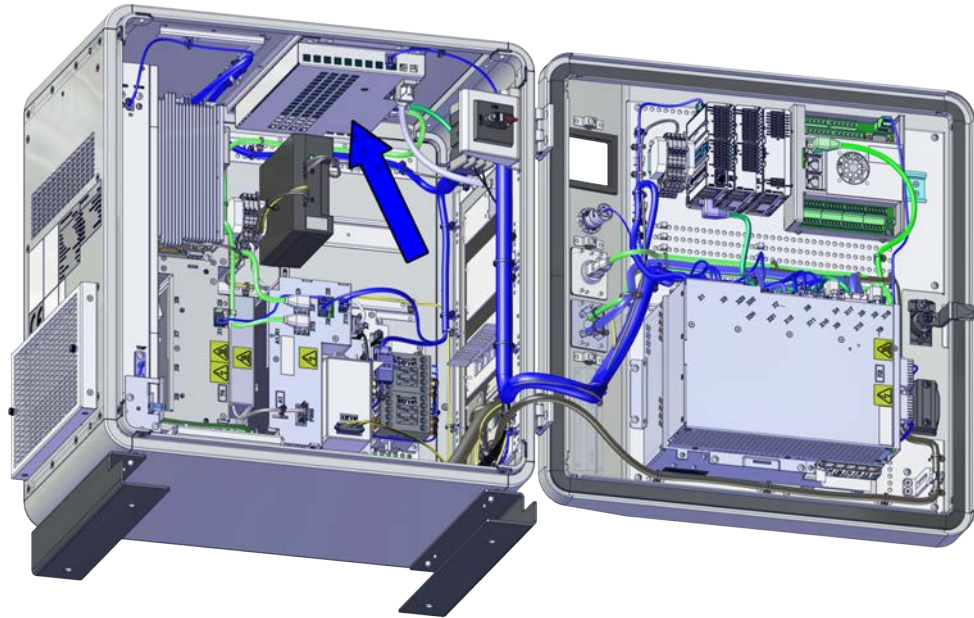

xx1900001462

Required spare parts



Note

The spare part numbers that are listed in the table can be out of date. See the latest spare parts of the OmniCore C90XT via myABB Business Portal, www.abb.com/myABB.

Spare part	Article number	Note
Axis Computer	3HAC029157-001	DSQC 668

Required tools and equipment

Equipment	Article number	Note
Standard toolkit	-	Content is defined in section Standard toolkit for controller on page 448 .
ESD protective wrist band	-	



Required documents

Document	Article number	Note
<i>Circuit diagram - OmniCore C90XT</i>	3HAC065464-009	

Continues on next page

Removing the axis computer

Preparations

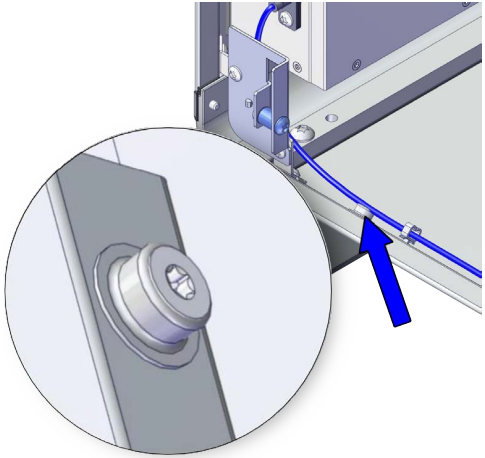
	Action	Note/Illustration
1	 DANGER Before doing any work inside the cabinet, disconnect the mains power. For more information, see Electrical safety on page 31 .	
2	Open the door.	Opening the door on page 188 .
3	 ELECTROSTATIC DISCHARGE (ESD) The unit is sensitive to ESD. Before handling the unit read the safety information in section The unit is sensitive to ESD on page 44 .	Location of wrist strap button:  xx1900001446

Removing the axis computer from the cabinet



	Action	Note/Illustration
1	Disconnect: <ul style="list-style-type: none"> • K6.X11 - A1.X3 • K6.X2 - A2.X9 • K6.X1 - K2.X3. 	
2	Loosen the screw and disconnect: <ul style="list-style-type: none"> • K6.X4, K6.X5 - SMB. 	

Continues on next page

5 Repair

5.2.2 Replacing the axis computer

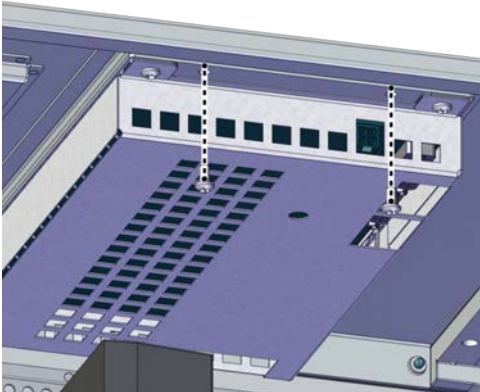
Continued

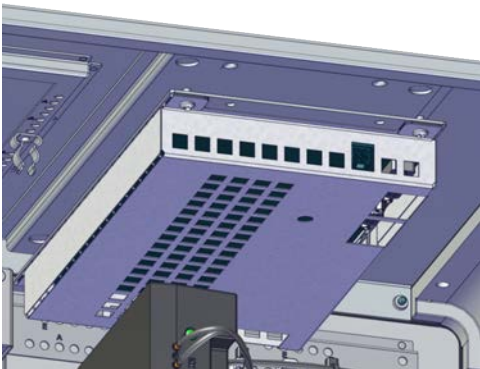
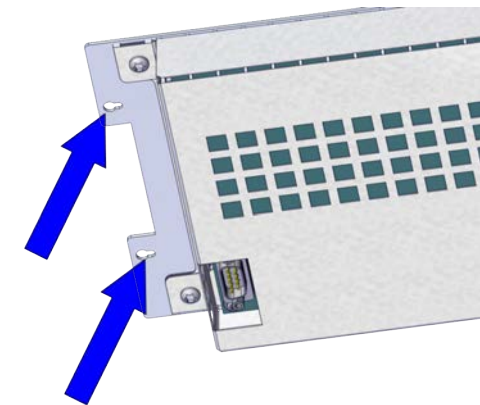
	Action	Note/Illustration
3	Remove the screws on the bracket.	 <p>xx1900001484</p>
4	<p>Take out the axis computer with the bracket from the cabinet.</p> <p> Tip</p> <p>Be careful with the locking hole on the cabinet when doing assembling or disassembling work.</p>	 <p>xx1900001485</p>  <p>xx1900001486</p>

Continues on next page

Removing the axis computer

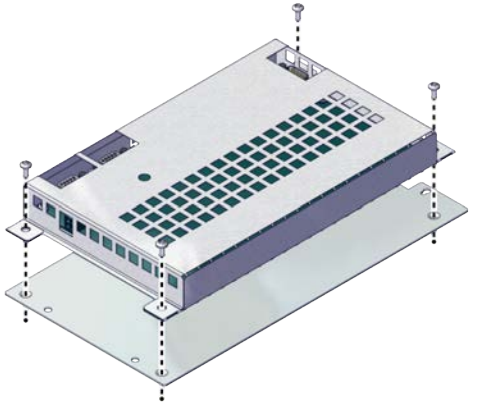
	Action	Note/Illustration
1	Remove the bracket screws.	 <p>xx1900001487</p>
2	Remove the axis computer.	

Refitting the axis computer

Refitting the axis computer

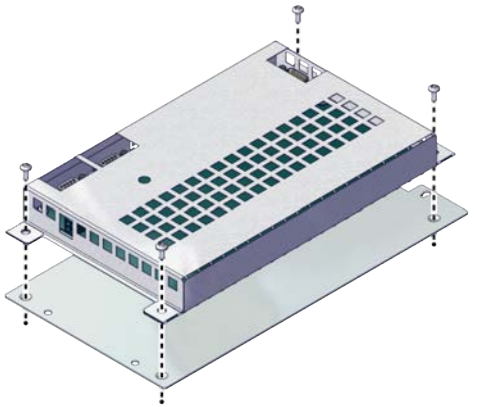
	Action	Note/Illustration
1	Refit the axis computer to the bracket and secure the screws.	<p>Screws: Torx pan head screw M4x8 (4 pcs) Tightening torque: 1.7 Nm±10%.</p>  <p>xx1900001487</p>

Refitting the axis computer to the frame

	Action	Note/Illustration
1	 <p>DANGER</p> <p>Before doing any work inside the cabinet, disconnect the mains power. For more information, see Electrical safety on page 31.</p>	

Continues on next page

5 Repair

5.2.2 Replacing the axis computer

Continued

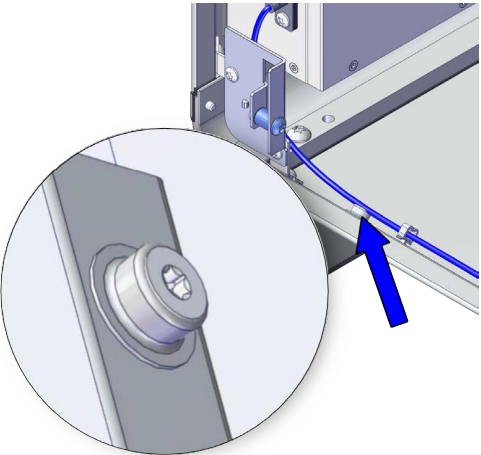
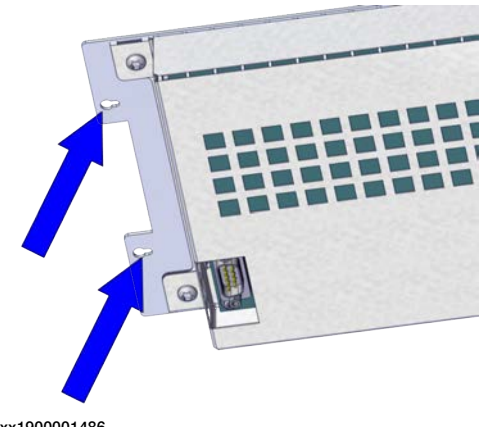
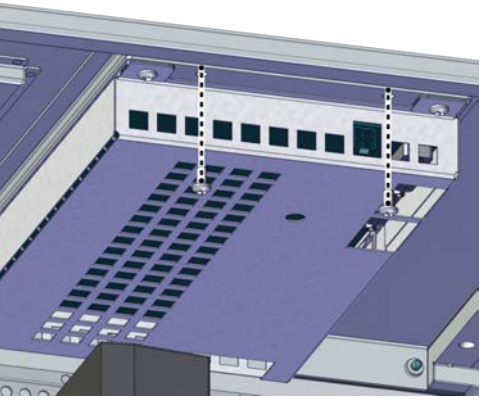
	Action	Note/Illustration
2	<p> ELECTROSTATIC DISCHARGE (ESD)</p> <p>The unit is sensitive to ESD. Before handling the unit read the safety information in section <i>The unit is sensitive to ESD on page 44</i>.</p>	<p>Location of wrist strap button:</p>  <p>xx1900001446</p>
3	<p>Fit the axis computer bracket and secure the screws.</p>	<p>Screws: Torx pan head screw M4x8 (4 pcs) Tightening torque: 1.7 Nm±10%.</p>  <p>xx1900001486</p>  <p>xx1900001484</p>
4	<p>Reconnect:</p> <ul style="list-style-type: none"> • K6.X11 - A1.X3 • K6.X2 - A2.X9 • K6.X1 - K2.X3 	

Continues on next page

	Action	Note/Illustration
5	Reconnect and secure the screw: <ul style="list-style-type: none">• K6.X4, K6.X5 - SMB.	

Concluding procedure

	Action	Note/Illustration
1	Close the door.	Closing the door on page 188.
2	Perform the function tests to verify that the safety features work properly, see Function tests on page 178.	

5 Repair

5.2.3 Replacing the fans

5.2.3 Replacing the fans

Location

The illustration shows the location of the fans in the controller.

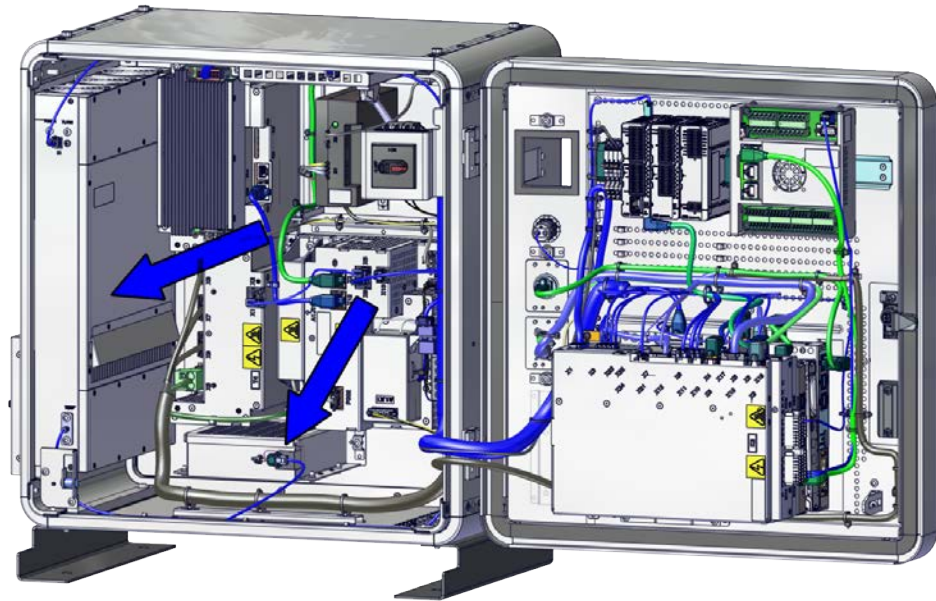

xx1900001463

Required spare parts



Note

The spare part numbers that are listed in the table can be out of date. See the latest spare parts of the OmniCore C90XT via myABB Business Portal, www.abb.com/myABB.

Spare part	Article number	Note
Standard size silent fan	3HAC077005-001	
Heat exchanger	3HAC065526-001	

Required tools and equipment

Equipment	Article number	Note
Standard toolkit	-	Content is defined in section Standard toolkit for controller on page 448 .
ESD protective wrist band	-	

Required documents

Document	Article number	Note
<i>Circuit diagram - OmniCore C90XT</i>	3HAC065464-009	



Continues on next page

5.2.3.1 Replacing the standard fans

5.2.3.1.1 Replacing the standard fan

Removing the standard fan

Preparations

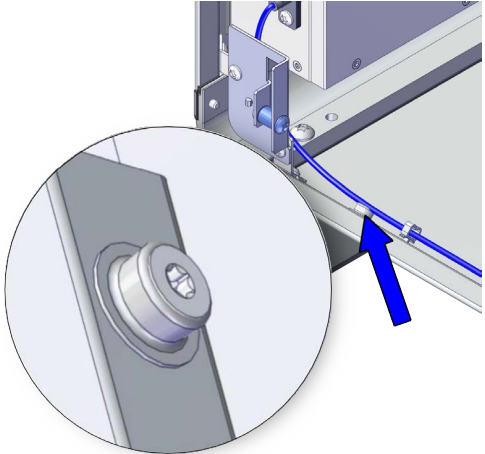
	Action	Note/Illustration
1	 DANGER Before doing any work inside the cabinet, disconnect the mains power. For more information, see Electrical safety on page 31 .	
2	Open the door.	Opening the door on page 188 .
3	 ELECTROSTATIC DISCHARGE (ESD) The unit is sensitive to ESD. Before handling the unit read the safety information in section The unit is sensitive to ESD on page 44 .	Location of wrist strap button:  xx1900001446

Removing the standard fan

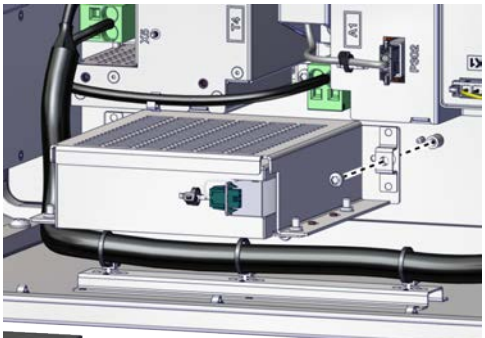
	Action	Note/Illustration
1	Disconnect standard fan: <ul style="list-style-type: none"> G1.X2-K2.X17 	
2	Remove the fan bracket screws.	 xx1900001488

Continues on next page



5 Repair

5.2.3.1.1 Replacing the standard fan

Continued

	Action	Note/Illustration
3	Take out the fan with the bracket.	

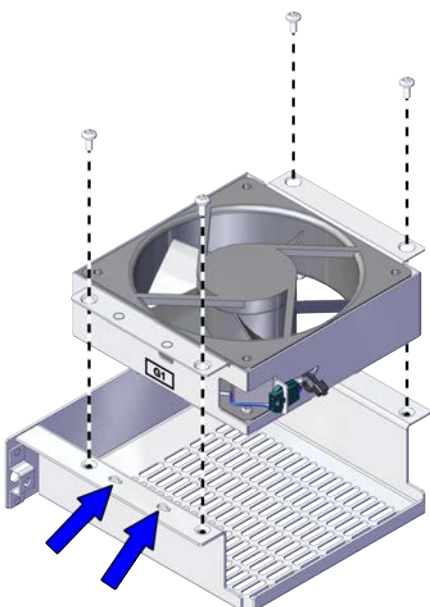
Removing the standard fan from the bracket

	Action	Note/Illustration
1	Remove the screws on the fan to the bracket.	 xx1900001489
2	Remove the fan from the bracket.  Tip Be careful with the locking hole on the cabinet when doing assembling or disassembling work.	

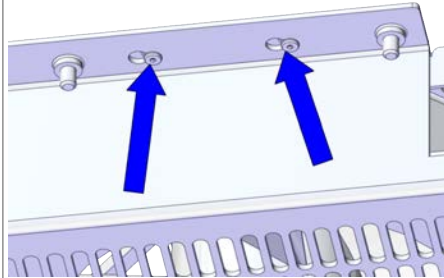

xx1900001498

Continues on next page

Refitting the standard fan

Refitting the standard fan to the bracket

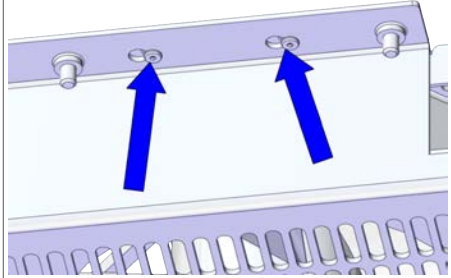
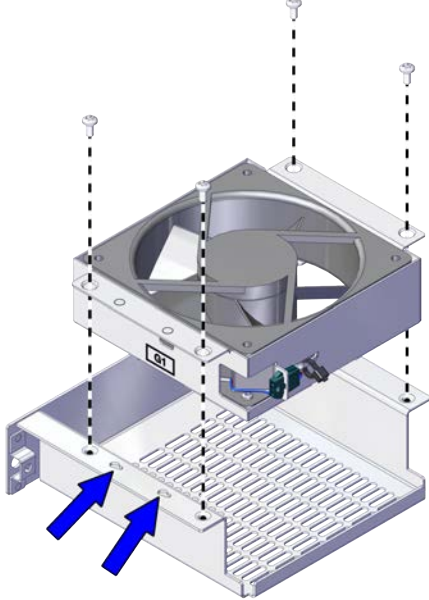
	Action	Note/Illustration
1	<p>Refit the standard fan to the bracket.</p> <p> Tip</p> <p>Be careful with the locking hole on the cabinet when doing assembling or disassembling work.</p>  <p>xx1900001498</p>	<p>Screws: Torx pan head screw M4x8 (4 pcs) Tightening torque: 1.7 Nm±10%.</p>  <p>xx1900001489</p>
2	<p>Secure the screws.</p>	

Refitting the standard fan

	Action	Note/Illustration
1	<p> DANGER</p> <p>Before doing any work inside the cabinet, disconnect the mains power. For more information, see Electrical safety on page 31.</p>	

Continues on next page

5 Repair

5.2.3.1.1 Replacing the standard fan

Continued

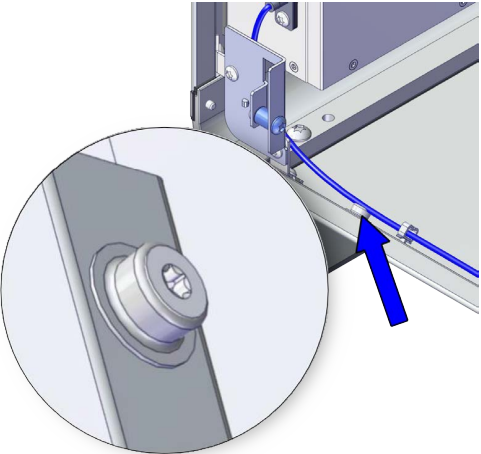
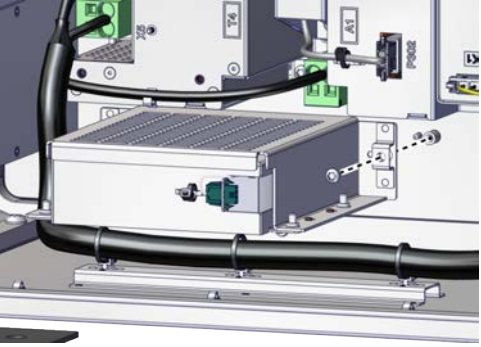
	Action	Note/Illustration
2	 <p>ELECTROSTATIC DISCHARGE (ESD)</p> <p>The unit is sensitive to ESD. Before handling the unit read the safety information in section <i>The unit is sensitive to ESD on page 44.</i></p>	<p>Location of wrist strap button:</p>  <p>xx1900001446</p>
3	<p>Refit the standard fan with the bracket into position according to the location pin.</p>	
4	<p>Secure the screws.</p>	<p>Screws: Torx pan head screw M4x8 (2 pcs) Tightening torque: 1.7 Nm±10%.</p>  <p>xx1900001488</p>
5	<p>Reconnect:</p> <ul style="list-style-type: none"> G1.X2-K2.X17 	



Concluding procedure

	Action	Note/Illustration
1	<p>Close the door.</p>	<p><i>Closing the door on page 188.</i></p>
2	<p>Perform the function tests to verify that the safety features work properly, see <i>Function tests on page 178.</i></p>	

5.2.3.2 Replacing the heat exchanger

Removing the heat exchanger

Preparations

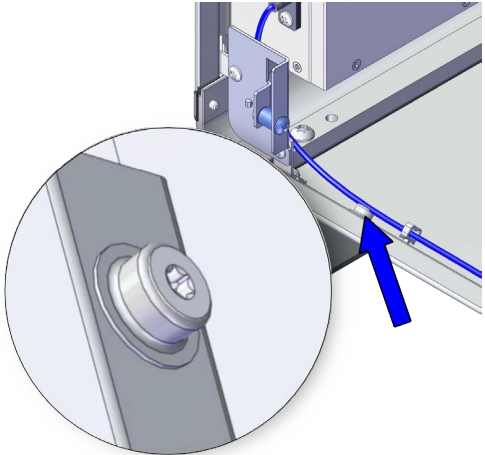
	Action	Note/Illustration
1	 DANGER Before doing any work inside the cabinet, disconnect the mains power. For more information, see Electrical safety on page 31 .	
2	Open the door.	Opening the door on page 188 .
3	 ELECTROSTATIC DISCHARGE (ESD) The unit is sensitive to ESD. Before handling the unit read the safety information in section The unit is sensitive to ESD on page 44 .	Location of wrist strap button:  xx1900001446

Removing the air filter

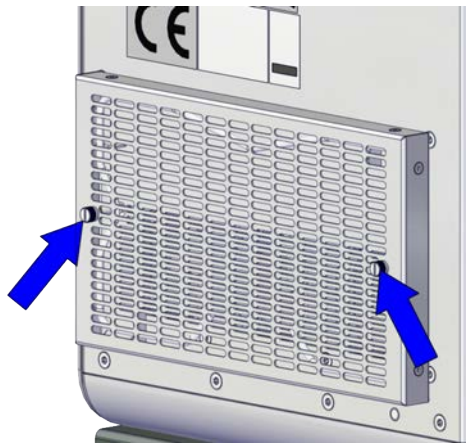
	Action	Note/Illustration
1	Loosen the attachment screws on the air filter.	 xx1900001491

Continues on next page

5 Repair

5.2.3.2 Replacing the heat exchanger

Continued

	Action	Note/Illustration
2	Remove the air filter unit.	 <p>xx1900001492</p>

Removing the heat exchanger

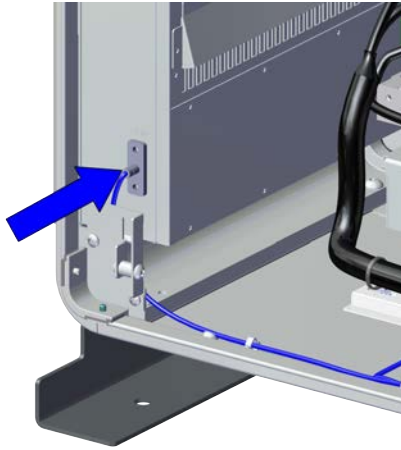
	Action	Note/Illustration
1	Disconnect heat exchanger: <ul style="list-style-type: none"><li data-bbox="507 954 703 987">• G3.X1-K2.X17	
2	Remove the screws locking the sensor and pull out the sensor.	 <p>xx1900001490</p>

Continues on next page

5.2.3.2 Replacing the heat exchanger
Continued

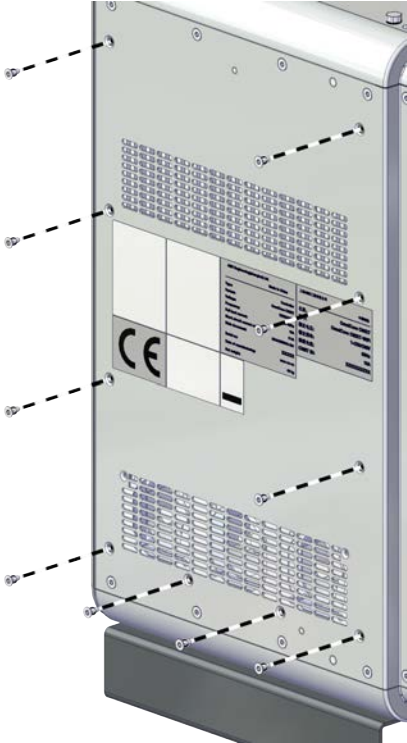
	Action	Note/Illustration
3	Remove the heat exchanger attachment screws.	 <p>xx1900001493</p>
4	Take out the heat exchanger.	

Refitting the heat exchanger

Refitting the heat exchanger



	Action	Note/Illustration
1	 <p>DANGER</p> <p>Before doing any work inside the cabinet, disconnect the mains power. For more information, see Electrical safety on page 31.</p>	

Continues on next page

5 Repair

5.2.3.2 Replacing the heat exchanger

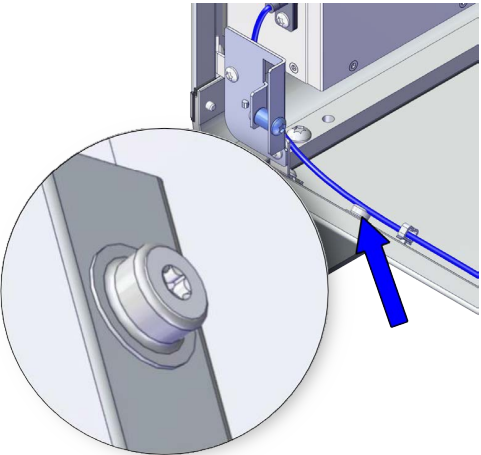
Continued

	Action	Note/Illustration
2	<p> ELECTROSTATIC DISCHARGE (ESD)</p> <p>The unit is sensitive to ESD. Before handling the unit read the safety information in section <i>The unit is sensitive to ESD on page 44</i>.</p>	<p>Location of wrist strap button:</p>  <p>xx1900001446</p>
3	<p>Refit the heat exchanger into position according to the location pin.</p>	 <p>xx1900001494</p>

Continues on next page

5.2.3.2 Replacing the heat exchanger
Continued

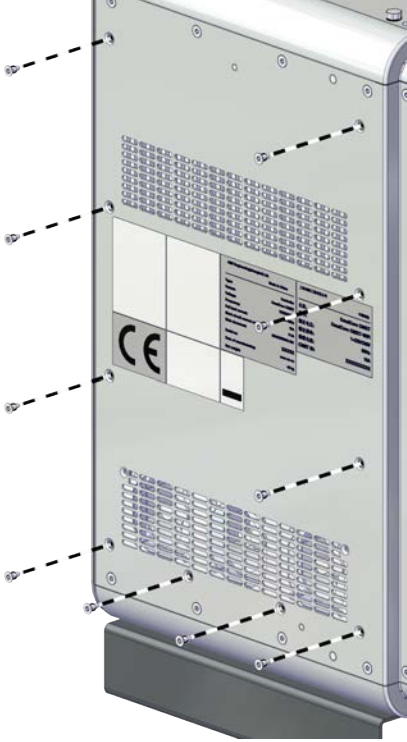
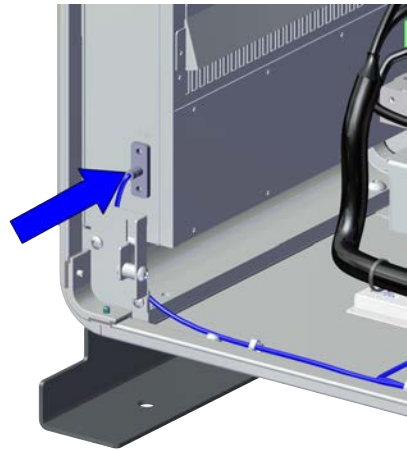
	Action	Note/Illustration
4	Secure the attachment screws.	<p>Screws: Torx, countersunk screw M4x10 (10 pcs) Tightening torque: 1.7 Nm±10%.</p>  <p>xx1900001493</p>
5	Reconnect: • G3.X1-K2.X17	
6	Refit the sensor cable and secure with screws.	<p>Screws: Torx pan head screw M4x8 (2 pcs) Tightening torque: 1.7 Nm±10%.</p>  <p>xx1900001490</p>



Continues on next page

5 Repair

5.2.3.2 Replacing the heat exchanger

Continued

Refitting the air filter

	Action	Note/Illustration
1	 DANGER Before doing any work inside the cabinet, disconnect the mains power. For more information, see Electrical safety on page 31 .	
2	Refit the air filter unit to the cabinet.	
3	Secure it with the screws.	 xx1900001492

Concluding procedure

	Action	Note/Illustration
1	Close the door.	Closing the door on page 188 .
2	Perform the function tests to verify that the safety features work properly, see Function tests on page 178 .	

5.2.3.3 Replacing the main computer fan

Location

The illustration shows the location of the main computer fan in the controller.

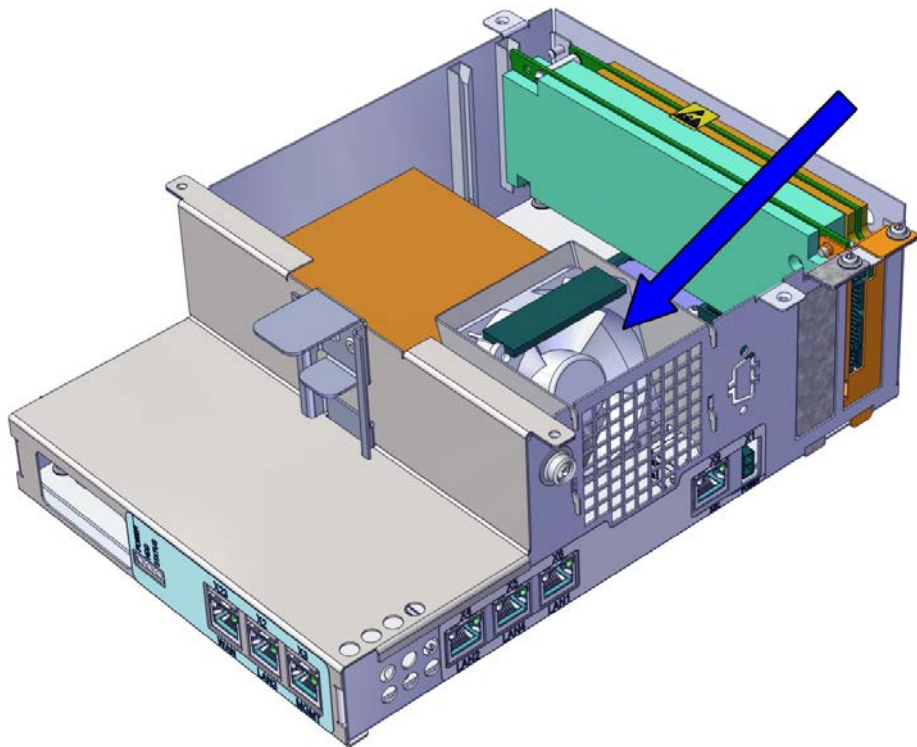

xx2100002178

Required spare parts



Note

The spare part numbers that are listed in the table can be out of date. See the latest spare parts of the OmniCore C90XT via myABB Business Portal, www.abb.com/myABB.

Spare part	Article number	Note
Fan with contact	3HAC060653-001	Main computer fan

Required tools and equipment

Equipment	Article number	Note
Standard toolkit	-	Content is defined in section Standard toolkit for controller on page 448 .
ESD protective wrist band	-	

Continues on next page

5 Repair

5.2.3.3 Replacing the main computer fan

Continued

Required documents

Document	Article number	Note
<i>Circuit diagram - OmniCore C90XT</i>	<i>3HAC065464-009</i>	



Removing the main computer fan



Note

The main computer fan is part of an assembly group, secured on a process plate. To remove the main computer fan, either lift out the assembly group and then remove the main computer fan, or take out the parts on top of the main computer and then remove the main computer fan.

Preparations

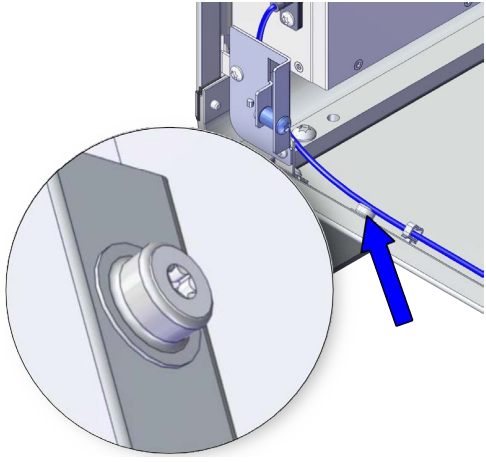
	Action	Note/Illustration
1	 DANGER Before doing any work inside the cabinet, disconnect the mains power. For more information, see Electrical safety on page 31 .	
2	Open the door.	Opening the door on page 188 .
3	 ELECTROSTATIC DISCHARGE (ESD) The unit is sensitive to ESD. Before handling the unit read the safety information in section The unit is sensitive to ESD on page 44 .	Location of wrist strap button:  xx1900001446

Continues on next page

Removing the robot signal exchange proxy

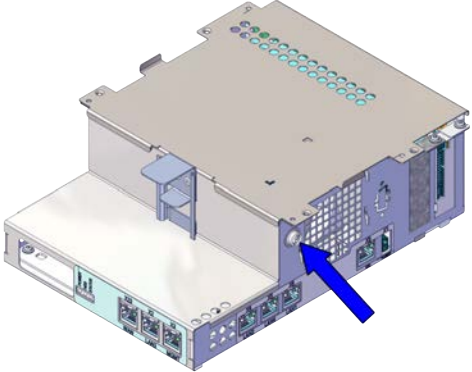
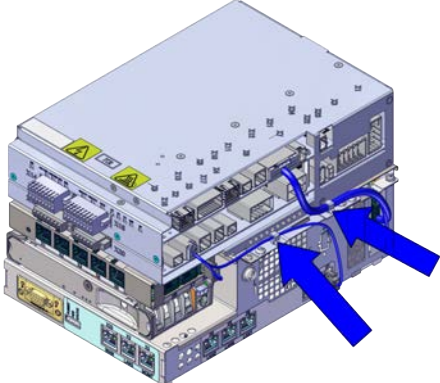
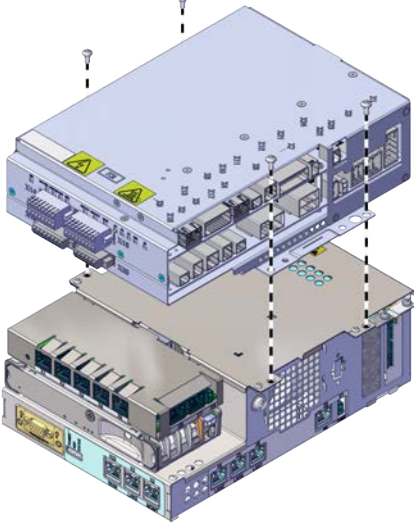
	Action	Note/Illustration
1	 <p>ELECTROSTATIC DISCHARGE (ESD)</p> <p>When handling the computer outside of the controller, use the wrist strap button located on the side of the computer.</p>	<p>Location of wrist strap button:</p>  <p>xx2000000419</p>
2	<p>Pull the cable ties out from the locking holes.</p>	 <p>xx1900001879</p>
3	<p>Remove the screws and lift out the robot signal exchange proxy.</p>	 <p>xx1900001880</p>

Continues on next page

5 Repair

5.2.3.3 Replacing the main computer fan

Continued

Removing the main computer fan

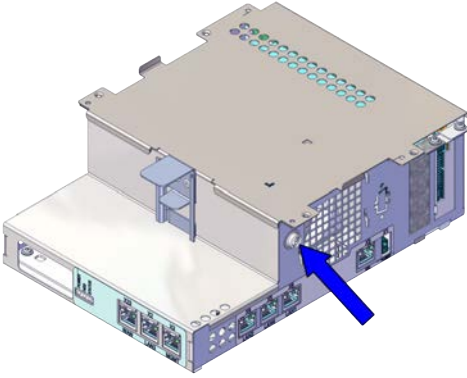
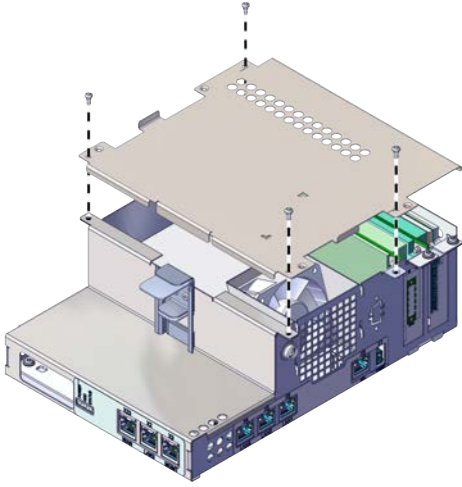
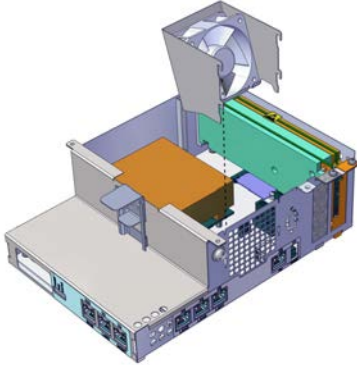

	Action	Note/Illustration
1	 <p>ELECTROSTATIC DISCHARGE (ESD)</p> <p>When handling the computer outside of the controller, use the wrist strap button located on the side of the computer.</p>	<p>Location of wrist strap button:</p>  <p>xx200000419</p>
2	<p>Remove the attachment screws and take off the cover.</p>	 <p>xx1900001909</p>
3	<p>Disconnect the main computer fan:</p> <ul style="list-style-type: none"> • A2.X1 	
4	<p>Lift the fan bracket off the hooks and remove it.</p>	 <p>xx2100002179</p>

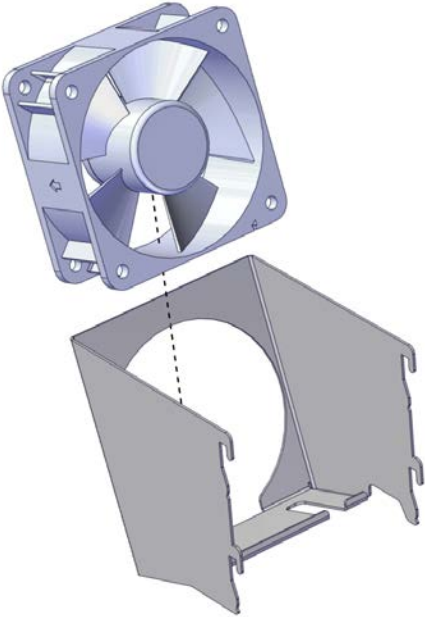
Continues on next page

	Action	Note/Illustration
5	Take out the fan from the bracket.	 <p data-bbox="954 1014 1062 1032">xx2100002180</p>

Refitting the main computer fan

Preparations

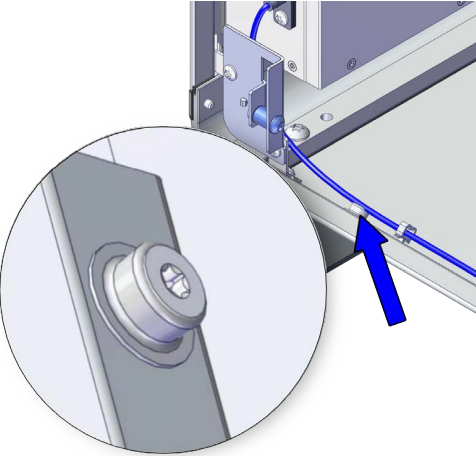
	Action	Note/Illustration
1	 <p data-bbox="592 1279 699 1308">DANGER</p> <p data-bbox="501 1341 944 1447">Before doing any work inside the cabinet, disconnect the mains power. For more information, see Electrical safety on page 31.</p>	
2	 <p data-bbox="592 1507 944 1561">ELECTROSTATIC DISCHARGE (ESD)</p> <p data-bbox="501 1581 944 1686">The unit is sensitive to ESD. Before handling the unit read the safety information in section The unit is sensitive to ESD on page 44.</p>	 <p data-bbox="954 1951 1062 1968">xx1900001446</p>

Continues on next page

5 Repair

5.2.3.3 Replacing the main computer fan

Continued

Refitting the main computer fan

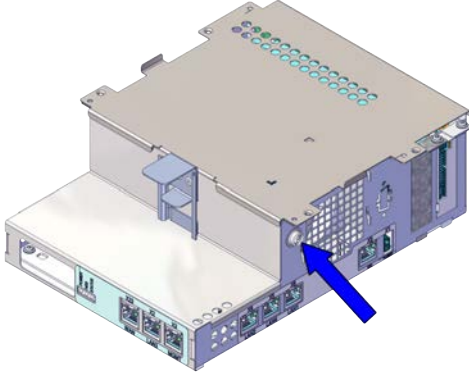
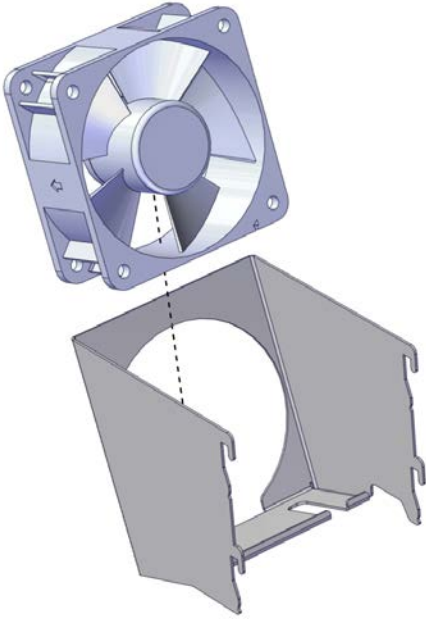
	Action	Note/Illustration
1	<p> ELECTROSTATIC DISCHARGE (ESD)</p> <p>When handling the computer outside of the controller, use the wrist strap button located on the side of the computer.</p>	<p>Location of wrist strap button:</p>  <p>xx2000000419</p>
2	<p>Place the main computer fan in the bracket.</p>	 <p>xx2100002180</p>

Continues on next page

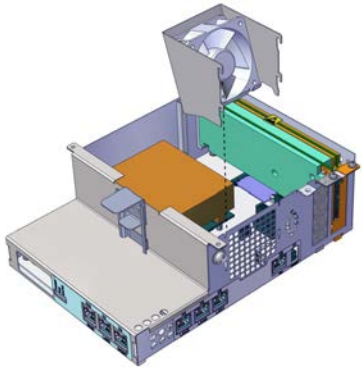
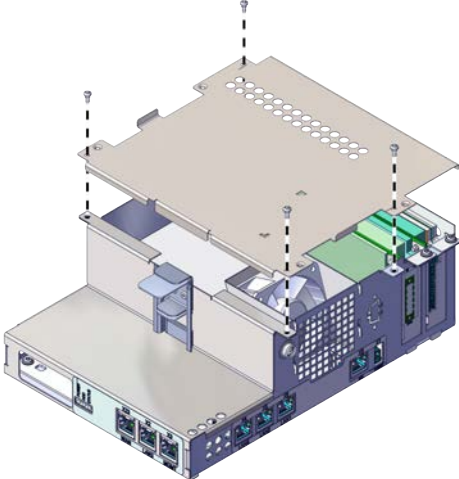
	Action	Note/Illustration
3	Position the fan bracket in the main computer using the hooks.	 <p>xx2100002179</p>
4	Connect the main computer fan: • A2.X1	
5	Refit the cover of the main computer and secure the screws.	<p>Screws: Hexalobular socket pan head screw M3x6 (4 pcs)</p>  <p>xx1900001909</p>

Refitting the robot signal exchange proxy

	Action	Note/Illustration
1	 <p>DANGER</p> <p>Before doing any work inside the cabinet, disconnect the mains power. For more information, see Electrical safety on page 31.</p>	

Continues on next page

5 Repair

5.2.3.3 Replacing the main computer fan

Continued

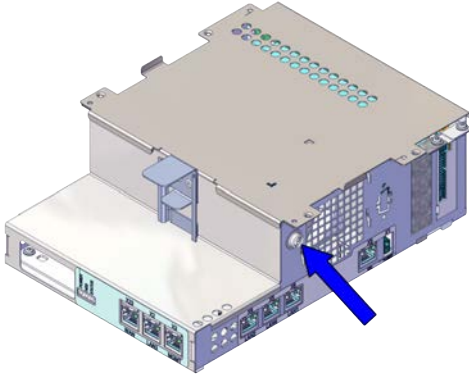
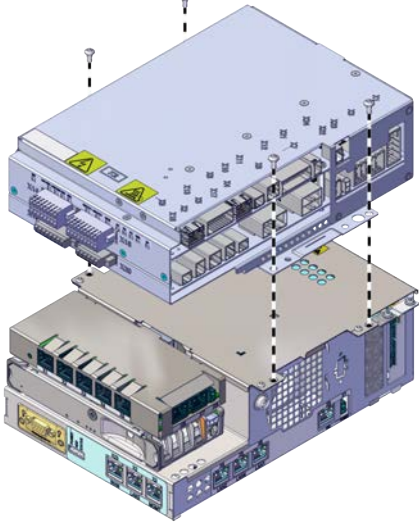
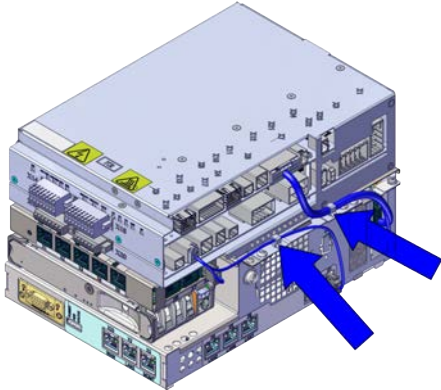
	Action	Note/Illustration
2	<p> ELECTROSTATIC DISCHARGE (ESD)</p> <p>The unit is sensitive to ESD. Before handling the unit read the safety information in section <i>The unit is sensitive to ESD on page 44</i>.</p>	<p>Location of wrist strap button:</p>  <p>xx200000419</p>
3	<p>Fit the robot signal exchange proxy and secure the screws.</p>	<p>Screws: Torx pan head screw M4x8 (4 pcs) Tightening torque: 1.7 Nm±10%.</p>  <p>xx1900001880</p>
4	<p>Insert the cable ties into the locking holes.</p>	 <p>xx1900001879</p>

Continues on next page

Concluding procedure

	Action	Note/Illustration
1	Close the door.	Closing the door on page 188.
2	Perform the function tests to verify that the safety features work properly, see Function tests on page 178.	

5 Repair

5.2.4 Replacing the robot signal exchange proxy

5.2.4 Replacing the robot signal exchange proxy

Location

The illustration shows the location of the robot signal exchange proxy in the controller.

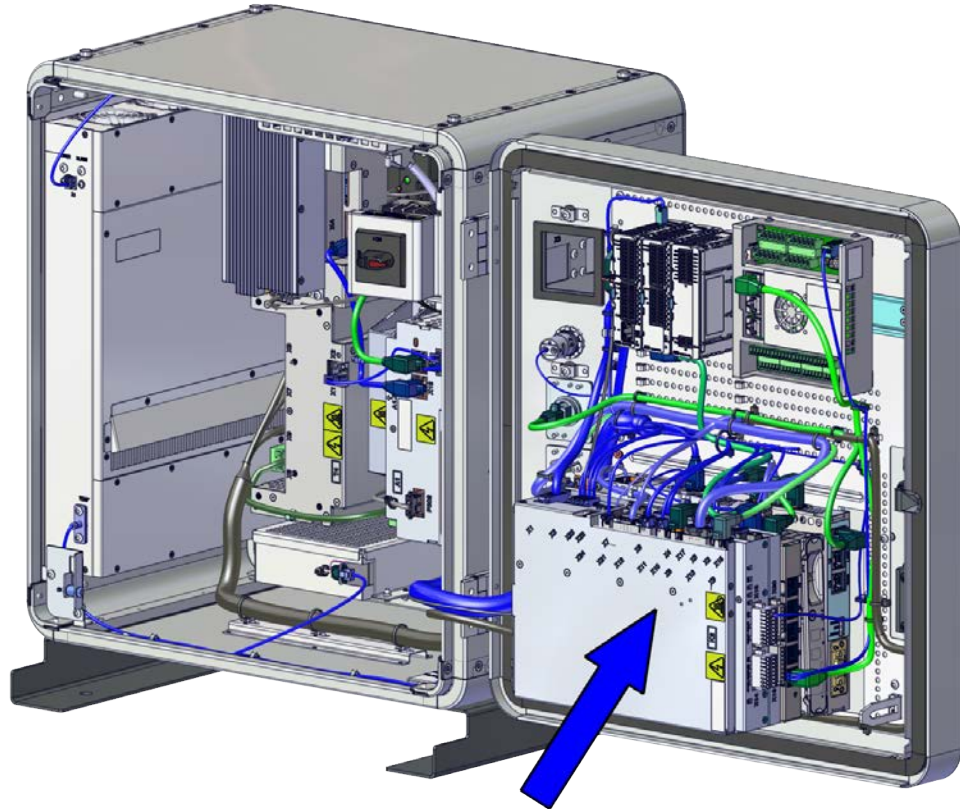

xx1900001464

Required spare parts



Note

The spare part numbers that are listed in the table can be out of date. See the latest spare parts of the OmniCore C90XT via myABB Business Portal, www.abb.com/myABB.

Spare part	Article number	Note
Signal exchange	3HAC064662-001	DSQC3037
Harness Short-circuit connector	3HAC065107-001	Mating connector for robot signal exchange proxy.
Harness 24_PC	3HAC064091-001	Harness K2.X2 - K4.X8, A2.X1
Harness dual channel safety	3HAC059273-001	Harness K2.X12 - K3.X6, K3.X7

Continues on next page



WARNING

NEVER open the robot signal exchange proxy.

There is residual voltage in the robot signal exchange proxy even the controller is power off in a short time.

Required tools and equipment

Equipment	Article number	Note
Standard toolkit	-	Content is defined in section Standard toolkit for controller on page 448 .
ESD protective wrist band	-	

Required documents

Document	Article number	Note
<i>Circuit diagram - OmniCore C90XT</i>	3HAC065464-009	

Removing the robot signal exchange proxy

Preparations

	Action	Note/Illustration
1	<p>DANGER</p> <p>Before doing any work inside the cabinet, disconnect the mains power. For more information, see Electrical safety on page 31.</p>	
2	Open the door.	Opening the door on page 188 .
3	<p>ELECTROSTATIC DISCHARGE (ESD)</p> <p>The unit is sensitive to ESD. Before handling the unit read the safety information in section The unit is sensitive to ESD on page 44.</p>	<p>Location of wrist strap button:</p> <p>xx1900001446</p>

Continues on next page

5 Repair

5.2.4 Replacing the robot signal exchange proxy

Continued

Removing the robot signal exchange proxy

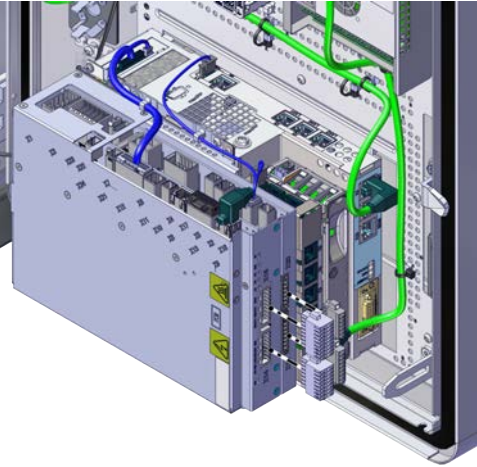
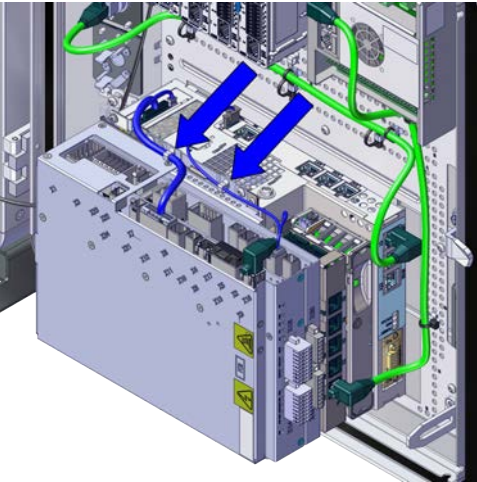
	Action	Note/Illustration
1	Disconnect: <ul style="list-style-type: none">• K2.X8 - A2.X6• (option): K2.X2 - K4.X8, A2.X1• K2.X12 - A2.K3.X6, A2.K3.X7• K2.X10 - A1.X13• K2.X21 - TempSensor (G3.TEMP)• K2.X4 - A1.X9• K2.X3 - K6.X1, A2.K3.X1, K5.1.X4, K7.X1• K2.X1 - T2.X2• K2.X17 - G3.X1, G1.X2• K2.X6, K2.X11 - A1.X2• K2.X7, K2.X22 - Harn. LV robot power (X1)• K2.X9 & X13 - FlexPendant (X4)	
2	Remove the mating connectors by loosening their attachment screws.	 <p>xx1900002339</p>
3	Pull the cable ties out from the locking holes.	 <p>xx1900001495</p>

Continues on next page

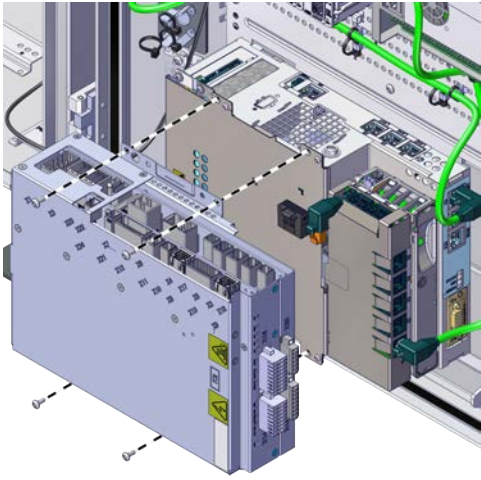

5.2.4 Replacing the robot signal exchange proxy

Continued

	Action	Note/Illustration
4	Remove the screws and lift out the robot signal exchange proxy.	 <p>xx1900001496</p>

Refitting the robot signal exchange proxy

Refitting the robot signal exchange proxy

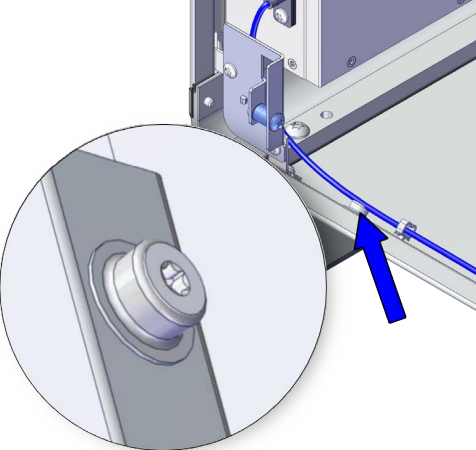
	Action	Note/Illustration
1	 <p>DANGER</p> <p>Before doing any work inside the cabinet, disconnect the mains power. For more information, see Electrical safety on page 31.</p>	
2	 <p>ELECTROSTATIC DISCHARGE (ESD)</p> <p>The unit is sensitive to ESD. Before handling the unit read the safety information in section The unit is sensitive to ESD on page 44.</p>	<p>Location of wrist strap button:</p>  <p>xx1900001446</p>

Continues on next page

5 Repair

5.2.4 Replacing the robot signal exchange proxy

Continued

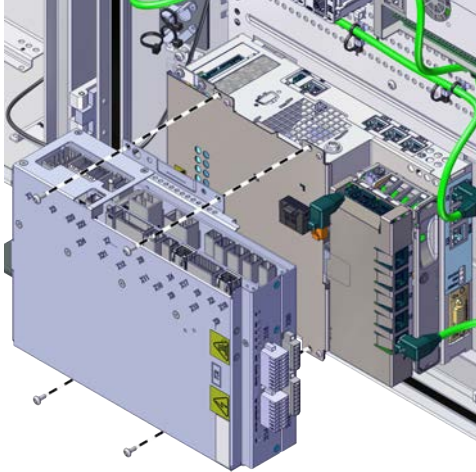
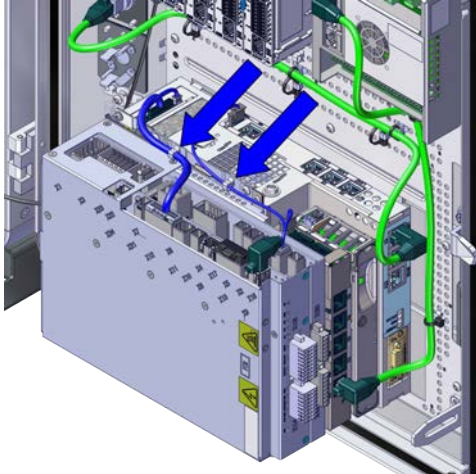
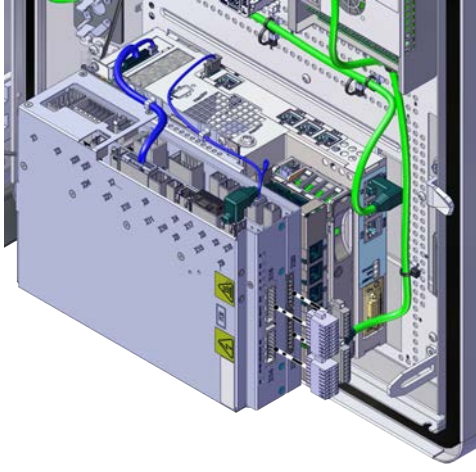
	Action	Note/Illustration
3	Fit the robot signal exchange proxy and secure the screws.	<p>Screws: Torx pan head screw M4x8 (4 pcs) Tightening torque: 1.7 Nm±10%.</p>  <p>xx1900001496</p>
4	Insert the cable ties into the locking holes.	 <p>xx1900001495</p>
5	Refit the mating connectors and secure their attachment screws.	 <p>xx1900002339</p>

Continues on next page

	Action	Note/Illustration
6	Reconnect: <ul style="list-style-type: none"> • K2.X8 - A2.X6 • (option): K2.X2 - K4.X8, A2.X1 • K2.X12 - A2.K3.X6, A2.K3.X7 • K2.X10 - A1.X13 • K2.X21 - TempSensor (G3.TEMP) • K2.X4 - A1.X9 • K2.X3 - K6.X1, A2.K3.X1, K5.1.X4, K7.X1 • K2.X1 - T2.X2 • K2.X17 - G3.X1, G1.X2 • K2.X6, K2.X11 - A1.X2 • K2.X7, K2.X22 - Harn. LV robot power (X1) • K2.X9 & X13 - FlexPendant (X4) 	

Concluding procedure

	Action	Note/Illustration
1	Close the door.	Closing the door on page 188.
2	Perform the function tests to verify that the safety features work properly, see Function tests on page 178.	

5 Repair

5.2.5 Replacing the Ethernet switch (DSQC1035)

5.2.5 Replacing the Ethernet switch (DSQC1035)

Location

The illustration shows the location of the Ethernet switch in the controller.

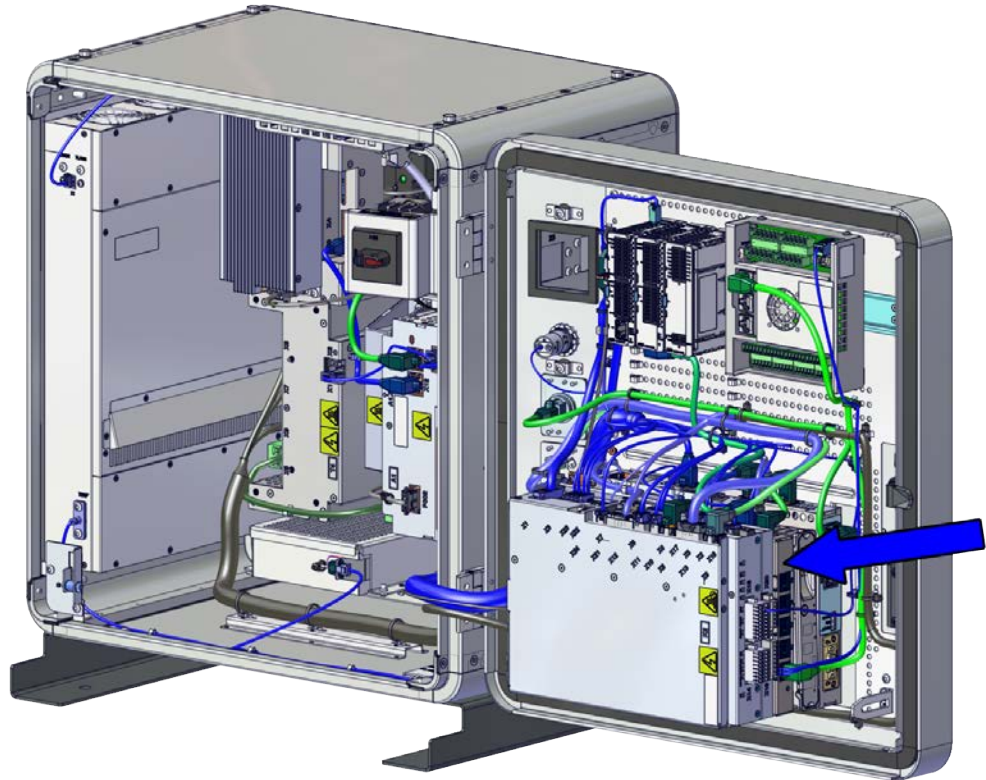

xx1900001465

Required spare parts



Note

The spare part numbers that are listed in the table can be out of date. See the latest spare parts of the OmniCore C90XT via myABB Business Portal, www.abb.com/myABB.

Spare part	Article number	Note
Ethernet Extension switch [3014-1]	3HAC059187-001	DSQC1035

Required tools and equipment

Equipment	Article number	Note
Standard toolkit	-	Content is defined in section Standard toolkit for controller on page 448 .
ESD protective wrist band	-	



Continues on next page

Required documents

Document	Article number	Note
Circuit diagram - OmniCore C90XT	3HAC065464-009	

Removing the Ethernet extension switch (option)

Preparations

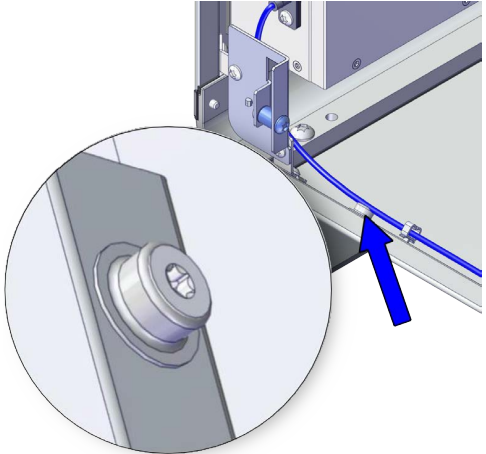
	Action	Note/Illustration
1	 DANGER Before doing any work inside the cabinet, disconnect the mains power. For more information, see Electrical safety on page 31 .	
2	Open the door.	Opening the door on page 188 .
3	 ELECTROSTATIC DISCHARGE (ESD) The unit is sensitive to ESD. Before handling the unit read the safety information in section The unit is sensitive to ESD on page 44 .	Location of wrist strap button:  xx1900001446

Removing the Ethernet extension switch (option)

	Action	Note/Illustration
1	Disconnect: <ul style="list-style-type: none"> • K2.X2 - K4.X8, A2.X1 • K4.X7 - K5.1.X5 • K4.X6 - A2.X4 	

Continues on next page

5 Repair

5.2.5 Replacing the Ethernet switch (DSQC1035)

Continued

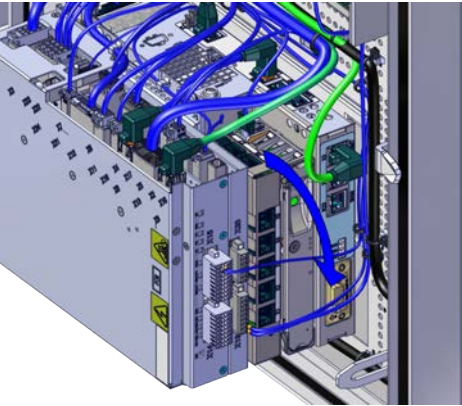
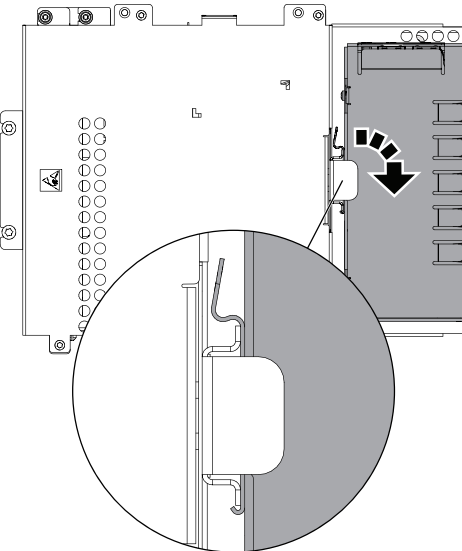

	Action	Note/Illustration
2	Carefully pull the side of the Ethernet extension switch and rotate it tightly to take it out from the bracket.	 <p data-bbox="927 725 1034 745">xx1900001499</p>  <p data-bbox="927 1323 1034 1344">xx1900002328</p>

Refitting the Ethernet extension switch (option)

Refitting the Ethernet extension switch (option)

	Action	Note/Illustration
1	 <p data-bbox="563 1585 671 1619">DANGER</p> <p data-bbox="472 1648 916 1760">Before doing any work inside the cabinet, disconnect the mains power. For more information, see Electrical safety on page 31.</p>	

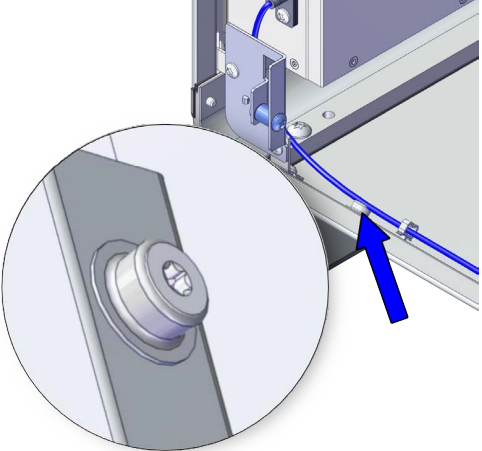
Continues on next page

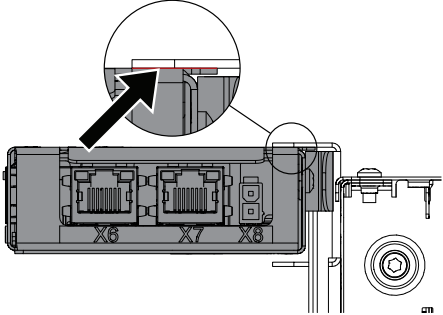
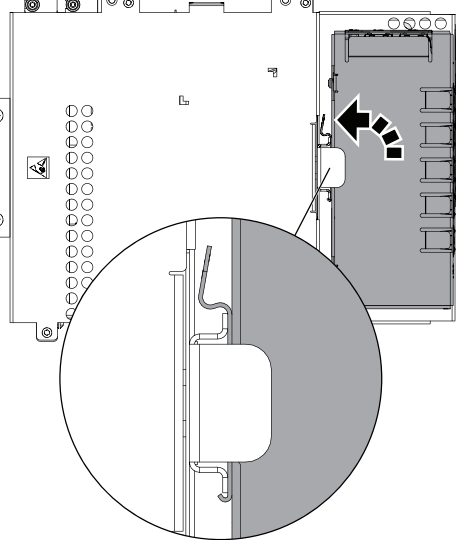
	Action	Note/Illustration
2	<p> ELECTROSTATIC DISCHARGE (ESD)</p> <p>The unit is sensitive to ESD. Before handling the unit read the safety information in section <i>The unit is sensitive to ESD on page 44.</i></p>	<p>Location of wrist strap button:</p>  <p>xx1900001446</p>
3	<p>Hook up the Ethernet extension switch to the bracket and then push the switch into position.</p> <p> Note</p> <p>During the installation, there should be no gap between the upper surface of the Ethernet extension switch and the lower surface of highest bracket on the main computer.</p>  <p>xx1800000972</p>	 <p>xx1900002330</p>
4	<p>Reconnect:</p> <ul style="list-style-type: none"> • K2.X2 - K4.X8, A2.X1 • K4.X7 - K5.1.X5 • K4.X6 - A2.X4 	

Concluding procedure

	Action	Note/Illustration
1	Close the door.	<i>Closing the door on page 188.</i>
2	Perform the function tests to verify that the safety features work properly, see <i>Function tests on page 178.</i>	

5 Repair

5.2.6 Replacing the 3G Connected Services gateway

5.2.6 Replacing the 3G Connected Services gateway

Location

The illustration shows the location of the Connected Services gateway in the controller. For the 3G variant, there is a sim card inside the unit.

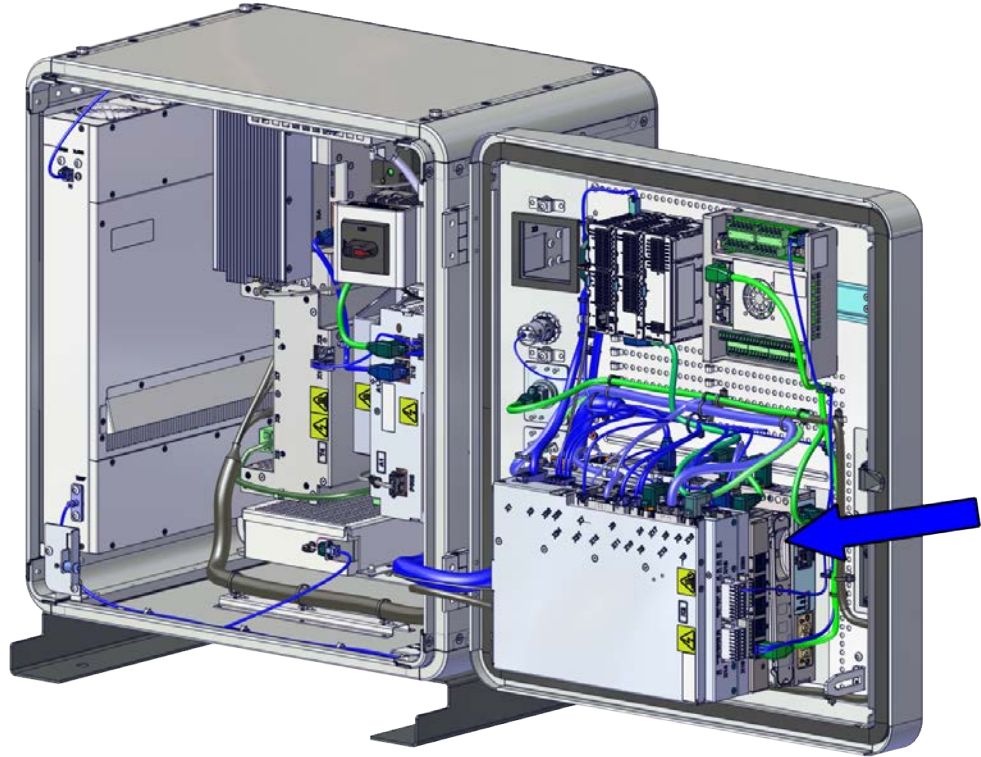

xx1900001466

Required spare parts



Note

The spare part numbers that are listed in the table can be out of date. See the latest spare parts of the OmniCore C90XT via myABB Business Portal, www.abb.com/myABB.

Spare part	Article number	Note
Connected Services-3G [3013-3]	3HAC060960-001	DSQC1039
Magnetic roof antenna, 3G	3HAC028459-001	
Connected Services-WiFi [3013-2]	3HAC060962-001	DSQC1040
Magnetic roof antenna, WiFi	3HAC059424-001	
Connected Services-Wired [3013-1]	3HAC061701-001	DSQC1041
Harness Ethernet with Mini-IO	3HAC061136-001	Harness A2.X5 - K7.X2

Continues on next page

5.2.6 Replacing the 3G Connected Services gateway
Continued

Required tools and equipment



Equipment	Article number	Note
Standard toolkit	-	Content is defined in section Standard toolkit for controller on page 448 .
ESD protective wrist band	-	

Required documents

Document	Article number	Note
Circuit diagram - OmniCore C90XT	3HAC065464-009	

Removing the Connected Services gateway

Preparations

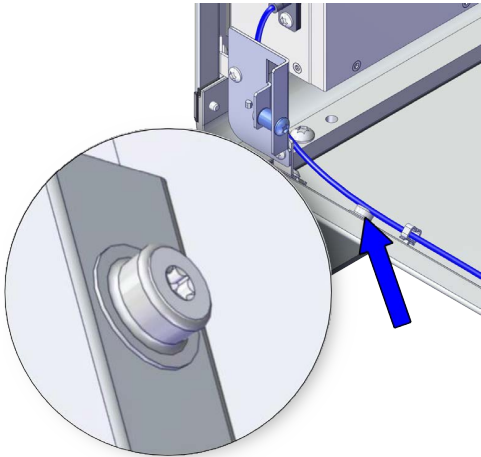
	Action	Note/Illustration
1	 DANGER Before doing any work inside the cabinet, disconnect the mains power. For more information, see Electrical safety on page 31 .	
2	Open the door.	Opening the door on page 188 .
3	 ELECTROSTATIC DISCHARGE (ESD) The unit is sensitive to ESD. Before handling the unit read the safety information in section The unit is sensitive to ESD on page 44 .	Location of wrist strap button:  xx1900001446

Disconnecting the antenna

	Action	Note/Illustration
1	Record the cable routing when you remove the antenna cable from the cabinet.	 Note The Connected Services antenna is installed by the customer, and the cable routing can therefore differ.

Continues on next page

5 Repair

5.2.6 Replacing the 3G Connected Services gateway

Continued

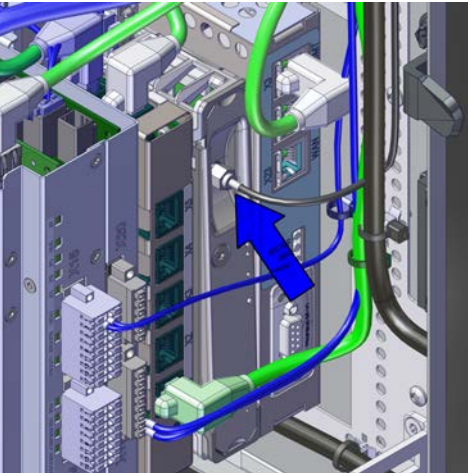
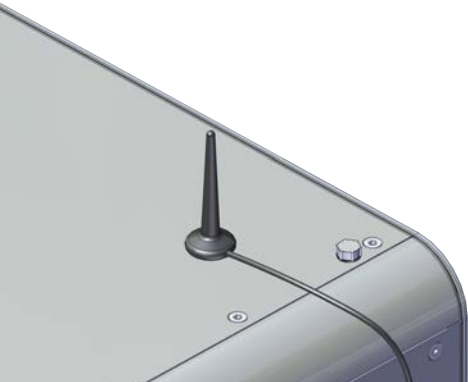
	Action	Note/Illustration
2	Disconnect the antenna cable from the Connected Services gateway by rotating the connector.	 <p>xx1900001948</p>
3	Remove any cable ties and protection.	
4	Pull the cable out through the cable grommet.	<p><i>Removing the cable grommet assembly on page 341.</i></p>
5	Remove the magnet part of the antenna from the cabinet.	 <p>xx1900001949</p>

Removing the Connected Services gateway

	Action	Note/Illustration
1	Disconnect: <ul style="list-style-type: none"> • K7.X1 - K2.X3ⁱ • K7.X2 - A2.X5 <div style="display: flex; align-items: center; margin-top: 10px;">  <p>Note</p> </div> <p>The connector K7.X2 is locked; grab the connector, push it in to release it and then remove the connector.</p>	

Continues on next page

5.2.6 Replacing the 3G Connected Services gateway
Continued

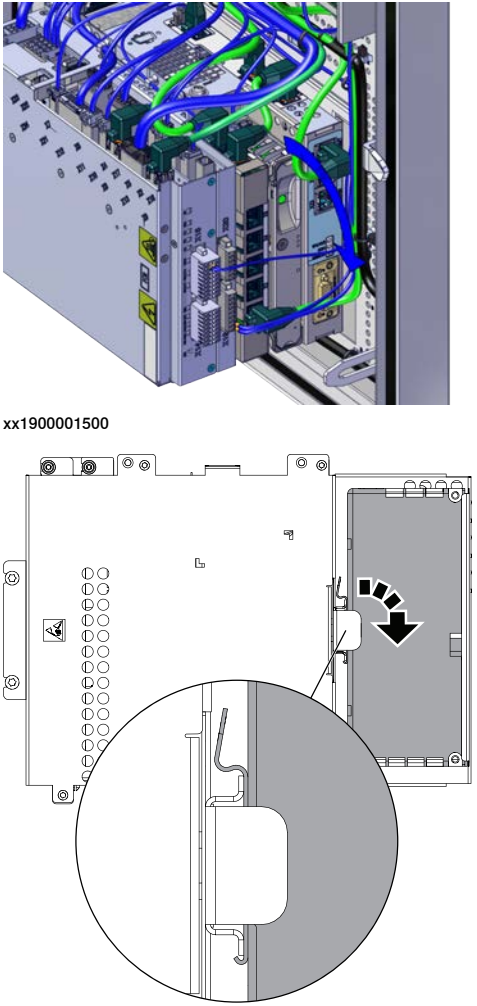
	Action	Note/Illustration
2	Carefully pull the side of the Connected Services gateway and rotate it tightly to take it out from the bracket.	 <p>xx1900001500</p> <p>xx1900002329</p>

i For connected services gateway wired, there is no power cable.

Removing the sim card

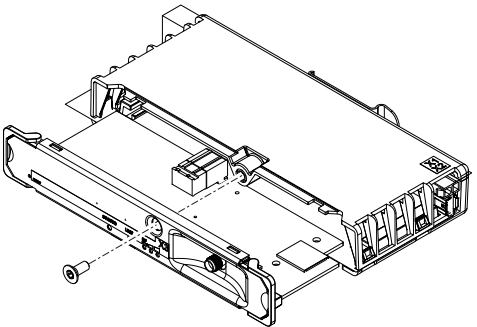
	Action	Note/Illustration
1	Remove the attachment screws and pull out the front cover of the Connected Services-3G.	 <p>xx1900000971</p>

Continues on next page

5 Repair

5.2.6 Replacing the 3G Connected Services gateway

Continued

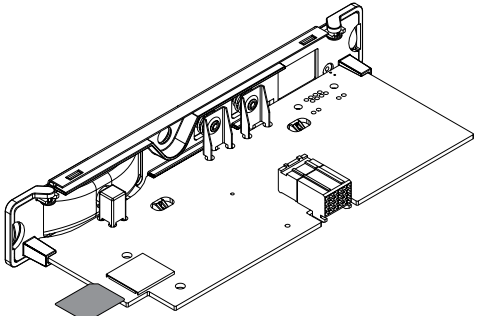
	Action	Note/Illustration
2	Carefully pull out the sim card from its holder.	 <p>xx1900000972</p>

Refitting the Connected Services gateway

Refitting the sim card

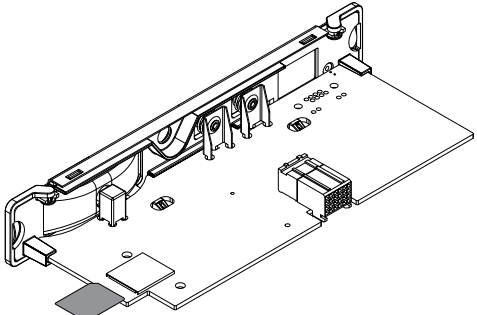
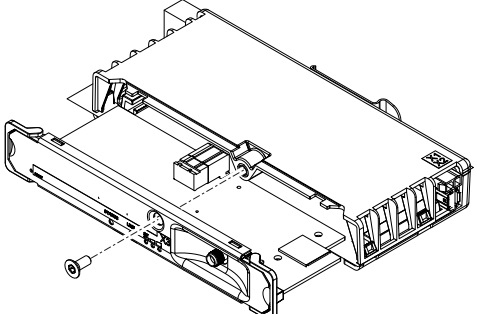



	Action	Note/Illustration
1	Carefully place the sim card in its holder.	 <p>xx1900000972</p>
2	Refit the front cover of the Connected Services-3G and secure the screws.	 <p>xx1900000971</p>

Refitting the Connected Services gateway

	Action	Note/Illustration
1	 <p>DANGER</p> <p>Before doing any work inside the cabinet, disconnect the mains power. For more information, see Electrical safety on page 31.</p>	

Continues on next page

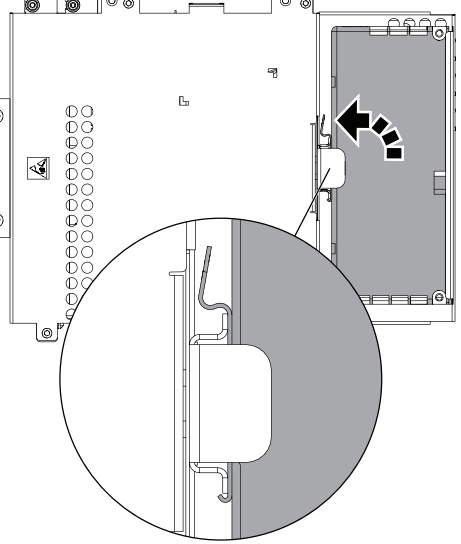
5.2.6 Replacing the 3G Connected Services gateway
Continued

	Action	Note/Illustration
2	 <p>ELECTROSTATIC DISCHARGE (ESD)</p> <p>The unit is sensitive to ESD. Before handling the unit read the safety information in section <i>The unit is sensitive to ESD on page 44.</i></p>	
3	<p>Hook up the Connected Services gateway to the bracket and push carefully into position.</p>  <p>Note</p> <p>During the installation, the gap between the lower surface of the connected services gateway and the upper surface of the main computer should be zero.</p>	 <p>xx1900002331</p>
4	<p>Reconnect:</p> <ul style="list-style-type: none"> • K7.X1 - K2.X3ⁱ • K7.X2 - A2.X5  <p>Note</p> <p>The connector K7.X2 is locked; grab the connector, push it in to release it and then remove the connector.</p>	

ⁱ For connected services gateway wired, there is no power cable.



Continues on next page

5 Repair

5.2.6 Replacing the 3G Connected Services gateway

Continued

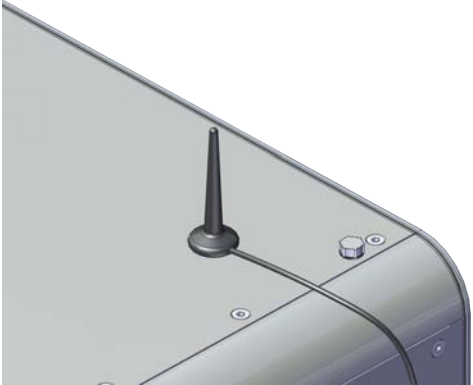
Reconnecting the antenna

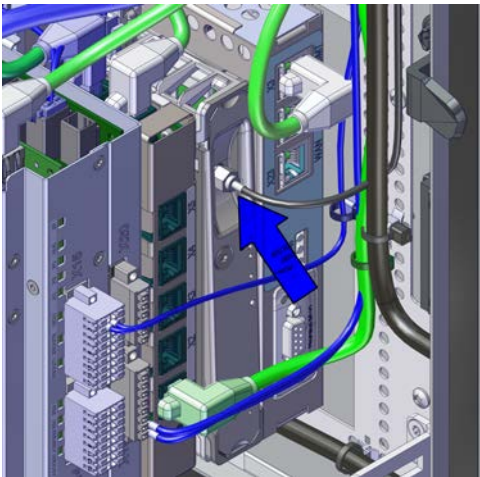
	Action	Note/Illustration
1	Place the magnet part of the antenna on the outside of the cabinet.	 <p data-bbox="924 842 1031 860">xx1900001949</p> <p data-bbox="927 887 983 943"> Note</p> <p data-bbox="924 954 1412 1061">The operating conditions must be such that there is a minimum separation distance of 20 cm between the dedicated antenna and nearby persons.</p>
2	Follow the cable routing recorded during the disassembly when you reconnect the antenna cable.	<p data-bbox="927 1111 983 1167"> Note</p> <p data-bbox="924 1178 1412 1256">The Connected Services antenna is installed by the customer, and the cable routing can therefore differ.</p>
3	Insert the antenna cable through the cable grommet.	<p data-bbox="924 1290 1412 1346"><i>Removing the cable grommet assembly on page 341.</i></p>
4	Apply cable ties and suitable cable protection to ensure that the cable may not be damaged by the door.	
5	Connect the antenna cable to the Connected Services gateway by rotating the connector.	 <p data-bbox="924 1946 1031 1964">xx1900001948</p>

Continues on next page

Concluding procedure

	Action	Note/Illustration
1	Close the door.	Closing the door on page 188.
2	Perform the function tests to verify that the safety features work properly, see Function tests on page 178.	

5 Repair

5.2.7 Replacing the scalable I/O unit

5.2.7 Replacing the scalable I/O unit

Location

The illustration shows the location of the scalable I/O in the controller.

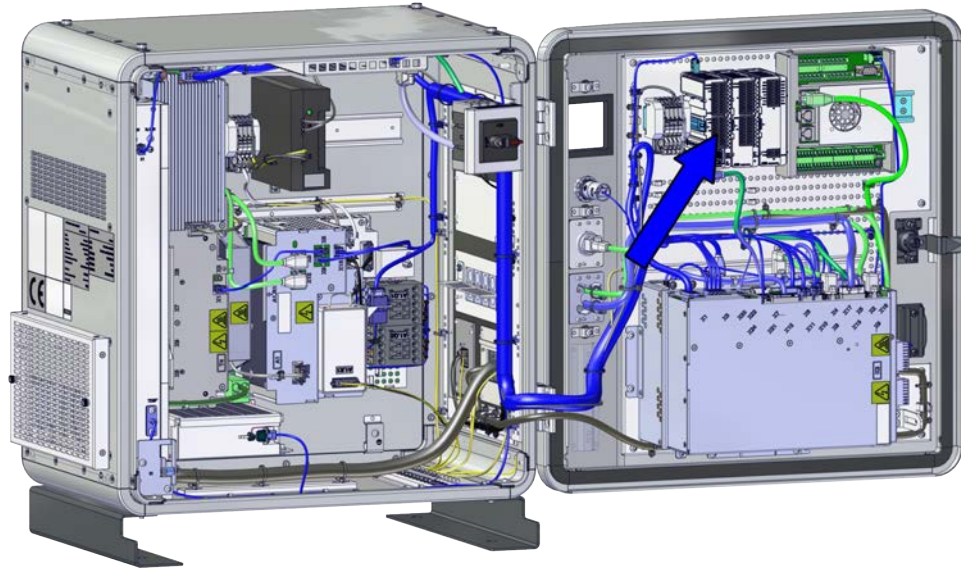

xx1900001467

Required spare parts



Note

The spare part numbers that are listed in the table can be out of date. See the latest spare parts of the OmniCore C90XT via myABB Business Portal, www.abb.com/myABB.

Spare part	Article number	Note
Scalable I/O Digital base [3032-1]	3HAC058663-001	DSQC1030
Connectors digital base/add on	3HAC060919-001	
Digital add-on [3033-2]	3HAC058664-001	DSQC1031
Analog add-on [3034-2]	3HAC058665-001	DSQC1032
Connectors I/O Analog	3HAC060925-001	
Relay add-on [3035-2]	3HAC058666-001	DSQC1033
Connectors I/O Relay	3HAC060926-001	

Required tools and equipment

Equipment	Article number	Note
Standard toolkit	-	Content is defined in section Standard toolkit for controller on page 448 .
ESD protective wrist band	-	



Continues on next page

Required documents

Document	Article number	Note
<i>Circuit diagram - OmniCore C90XT</i>	3HAC065464-009	
<i>Application manual - Scalable I/O</i>	3HAC070208-001	

Removing the digital base (option)

Preparations

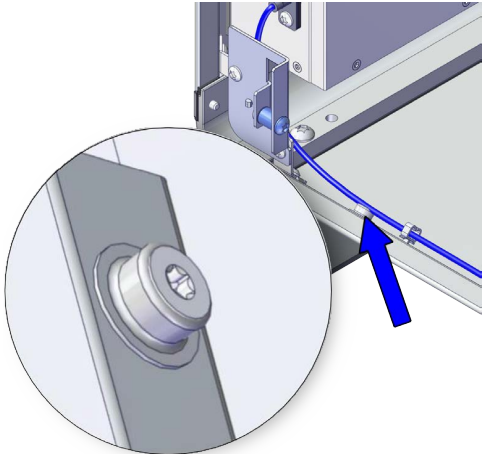
	Action	Note/Illustration
1	 DANGER Before doing any work inside the cabinet, disconnect the mains power. For more information, see Electrical safety on page 31 .	
2	Open the door.	Opening the door on page 188 .
3	 ELECTROSTATIC DISCHARGE (ESD) The unit is sensitive to ESD. Before handling the unit read the safety information in section The unit is sensitive to ESD on page 44 .	Location of wrist strap button:  xx1900001446

Continues on next page

5 Repair

5.2.7 Replacing the scalable I/O unit

Continued

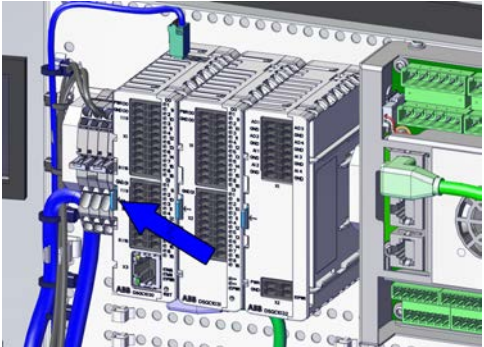
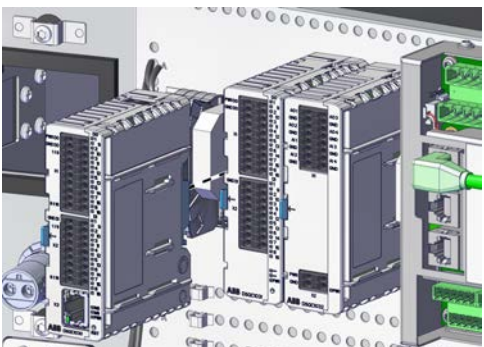

Removing the digital base (option)

	Action	Note/Illustration
1	<p>Disconnect:</p> <ul style="list-style-type: none">• K5.1.X5 - A2.X4/K4.X7 <p> Note</p> <p>If the Ethernet extension switch is installed, connect and disconnect the connector K5.1.X5 to/from K4.X7.</p> <p>If the Ethernet extension switch is not installed, connect and disconnect the connector K5.1.X5 to/from A2.X4.</p> <ul style="list-style-type: none">• K5.1.X4 - K2.X3• The harness connected to I/O unit by customer	
2	<p>Push the buckle of the digital base slightly and take out the digital base.</p>	 <p>xx1900002446</p>  <p>xx1900002447</p>

Continues on next page

Refitting the digital base (option)

Refitting the digital base (option)

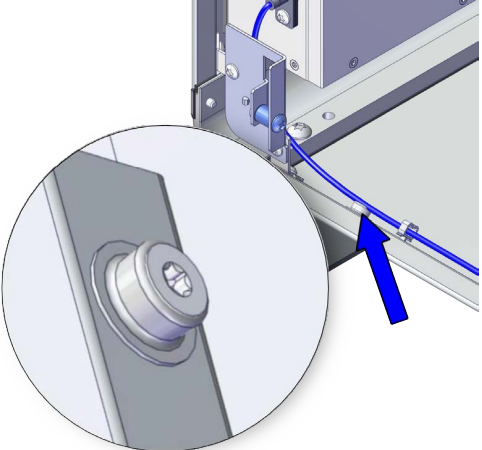
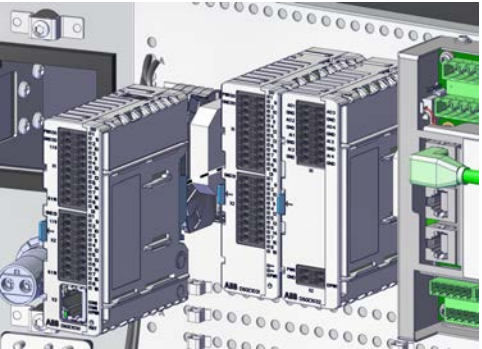
	Action	Note/Illustration
1	 <p>DANGER</p> <p>Before doing any work inside the cabinet, disconnect the mains power. For more information, see Electrical safety on page 31.</p>	
2	 <p>ELECTROSTATIC DISCHARGE (ESD)</p> <p>The unit is sensitive to ESD. Before handling the unit read the safety information in section The unit is sensitive to ESD on page 44.</p>	<p>Location of wrist strap button:</p>  <p>xx1900001446</p>
3	<p>Push the digital base into the bracket until you hear a clear clicking sound.</p>	 <p>xx1900002447</p>

Continues on next page

5 Repair

5.2.7 Replacing the scalable I/O unit

Continued

	Action	Note/Illustration
4	<p>Connect the adapter cable to the digital base.</p> <ul style="list-style-type: none">• K5.1.X5 - A2.X4/K4.X7 <p> Note</p> <p>If the Ethernet extension switch is installed, connect and disconnect the connector K5.1.X5 to/from K4.X7.</p> <p>If the Ethernet extension switch is not installed, connect and disconnect the connector K5.1.X5 to/from A2.X4.</p> <ul style="list-style-type: none">• K5.1.X4 - K2.X3• The harness connected to I/O unit by customer	

Concluding procedure

	Action	Note/Illustration
1	Close the door.	Closing the door on page 188.
2	Perform the function tests to verify that the safety features work properly, see Function tests on page 178.	

5.2.8 Replacing the safety digital base device

Location

The illustration shows the location of the safety digital base device in the controller.

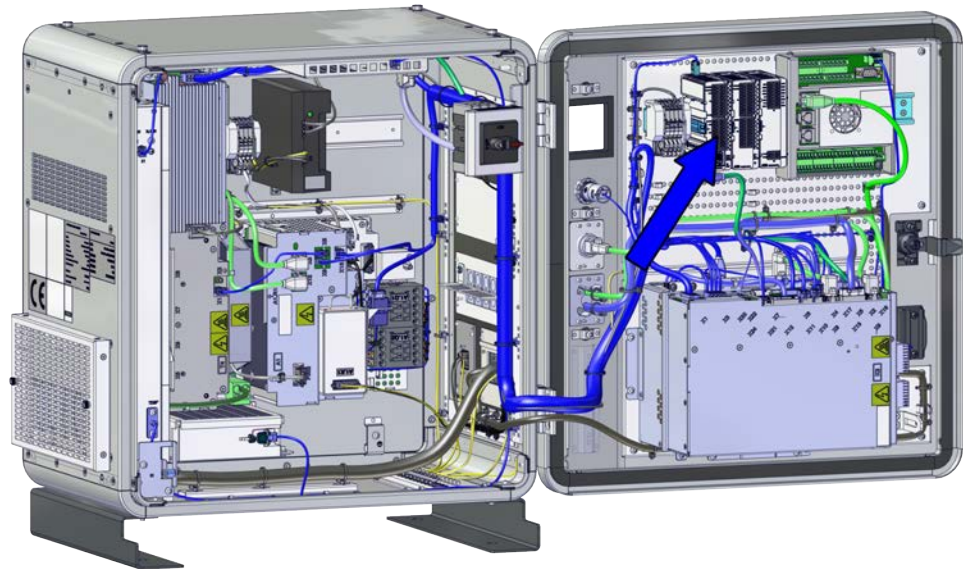

xx1900001467

Required spare parts



Note

The spare part numbers that are listed in the table can be out of date. See the latest spare parts of the OmniCore C90XT via myABB Business Portal, www.abb.com/myABB.

Spare part	Article number	Note
DSQC1042 Extended safety	3HAC062908-001	DSQC1042
Connectors Safety I/O	3HAC069538-001	

Required tools and equipment

Equipment	Article number	Note
Standard toolkit	-	Content is defined in section Standard toolkit for controller on page 448 .
ESD protective wrist band	-	

Required documents

Document	Article number	Note
<i>Circuit diagram - OmniCore C90XT</i>	3HAC065464-009	
<i>Application manual - Scalable I/O</i>	3HAC070208-001	

Continues on next page



5 Repair

5.2.8 Replacing the safety digital base device

Continued

Removing the safety digital base device

Preparations

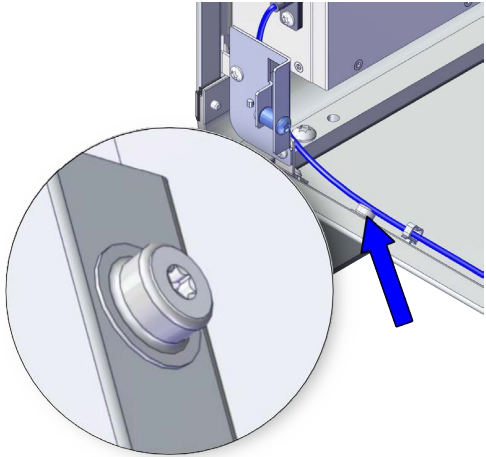
	Action	Note/Illustration
1	 DANGER Before doing any work inside the cabinet, disconnect the mains power. For more information, see Electrical safety on page 31 .	
2	Open the door.	Opening the door on page 188 .
3	 ELECTROSTATIC DISCHARGE (ESD) The unit is sensitive to ESD. Before handling the unit read the safety information in section The unit is sensitive to ESD on page 44 .	Location of wrist strap button:  xx1900001446

Removing the safety digital base device

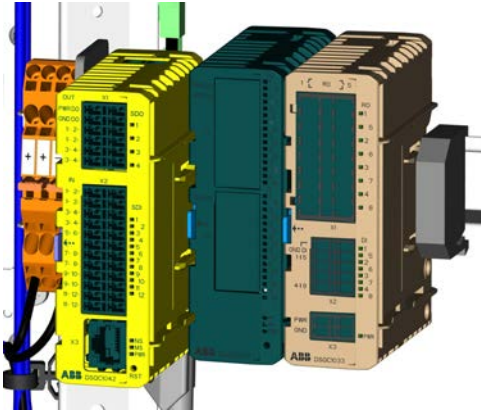

	Action	Note/Illustration
1	Disconnect: <ul style="list-style-type: none"> • K3.1.X5 - A2.X4/K4.X7  Note If the Ethernet extension switch is installed, connect and disconnect the connector K5.1.X5 to/from K4.X7. If the Ethernet extension switch is not installed, connect and disconnect the connector K5.1.X5 to/from A2.X4. <ul style="list-style-type: none"> • K3.1.X4 - K2.X3 • The harness connected to I/O unit by customer 	

Continues on next page

	Action	Note/Illustration
2	Push the buckle of the digital base slightly and take out the digital base.	 <p>xx2200001972</p>

Refitting the safety digital base device

Refitting the safety digital base device

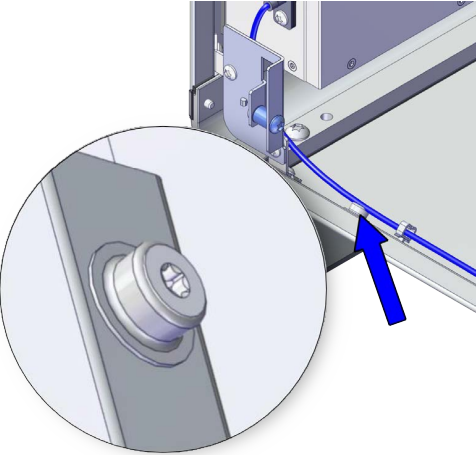

	Action	Note/Illustration
1	 <p>DANGER</p> <p>Before doing any work inside the cabinet, disconnect the mains power. For more information, see Electrical safety on page 31.</p>	
2	 <p>ELECTROSTATIC DISCHARGE (ESD)</p> <p>The unit is sensitive to ESD. Before handling the unit read the safety information in section The unit is sensitive to ESD on page 44.</p>	<p>Location of wrist strap button:</p>  <p>xx1900001446</p>

Continues on next page

5 Repair

5.2.8 Replacing the safety digital base device

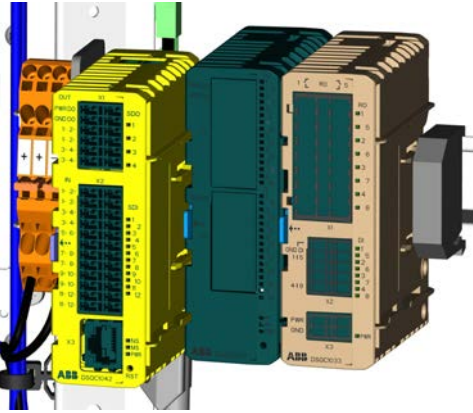
Continued

	Action	Note/Illustration
3	<p>Push the digital base into the bracket until you hear a clear clicking sound.</p>	 <p>xx2200001972</p>
4	<p>Connect the adapter cable to the digital base.</p> <ul style="list-style-type: none"> • K3.1.X5 - A2.X4/K4.X7 <p> Note</p> <p>If the Ethernet extension switch is installed, connect and disconnect the connector K5.1.X5 to/from K4.X7.</p> <p>If the Ethernet extension switch is not installed, connect and disconnect the connector K5.1.X5 to/from A2.X4.</p> <ul style="list-style-type: none"> • K3.1.X4 - K2.X3 • The harness connected to I/O unit by customer 	

Concluding procedure

	Action	Note/Illustration
1	Close the door.	Closing the door on page 188.
2	Perform the function tests to verify that the safety features work properly, see Function tests on page 178.	

5.2.9 Replacing the main computer

Location

The illustration shows the location of the main computer in the controller.

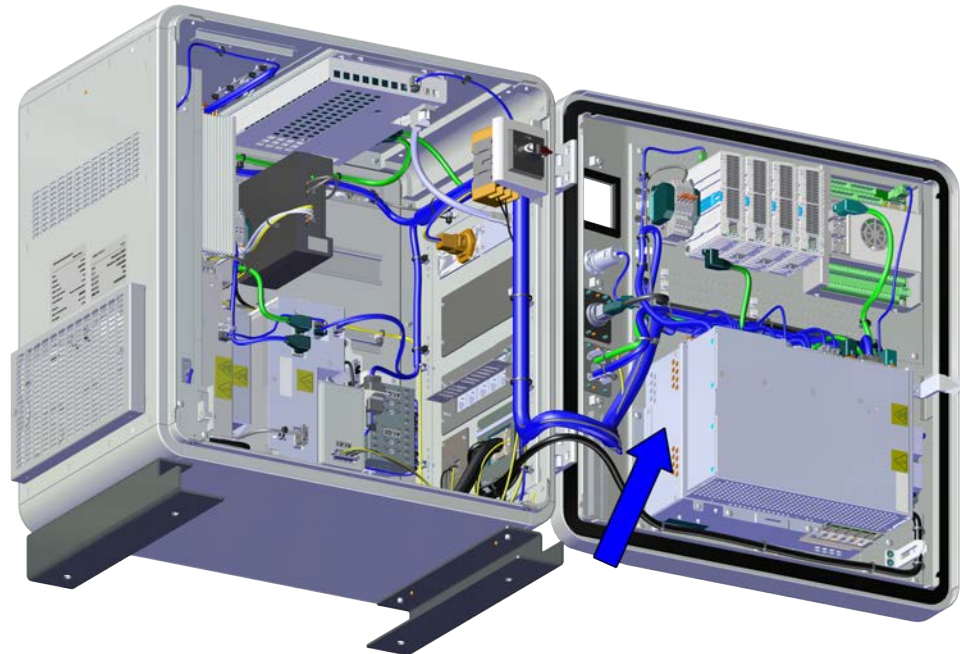

xx1900001468

Required spare parts



Note

The spare part numbers that are listed in the table can be out of date. See the latest spare parts of the OmniCore C90XT via myABB Business Portal, www.abb.com/myABB.

Spare part	Article number	Note
Main computer module assembly	3HAC063061-001	

Required tools and equipment



Note

For robots with the controller delivered to start in automatic mode, a FlexPendant is required after the replacement to be able to change to automatic mode.

Equipment	Article number	Note
Standard toolkit	-	Content is defined in section Standard toolkit for controller on page 448 .

Continues on next page

5 Repair

5.2.9 Replacing the main computer

Continued

Equipment	Article number	Note
ESD protective wrist band	-	

Required documents

Document	Article number	Note
<i>Circuit diagram - OmniCore C90XT</i>	<i>3HAC065464-009</i>	



Note



The main computer is part of an assembly group, secured on a process plate. To remove the computer, either lift out the assembly group and then remove the computer, or take out the parts on top of the computer and then the computer itself.

To remove the assembly group, see [Removing the main computer by assembly group on page 244](#).

To remove the modules on the top of the computer, see [Removing the main computer by parts on page 257](#).

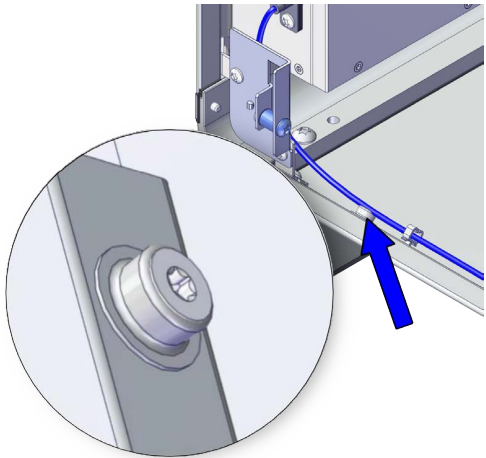

Removing the main computer by assembly group

Preparations

	Action	Note/Illustration
1	 DANGER Before doing any work inside the cabinet, disconnect the mains power. For more information, see Electrical safety on page 31 .	
2	Open the door.	Opening the door on page 188 .
3	 ELECTROSTATIC DISCHARGE (ESD) The unit is sensitive to ESD. Before handling the unit read the safety information in section The unit is sensitive to ESD on page 44 .	Location of wrist strap button:  xx1900001446

Continues on next page

Removing the main computer assembly



	Action	Note/Illustration
1	Disconnect all the connectors on the assembly group of the robot signal exchange proxy, Ethernet switch (option), connected services gateway, and main computer.	
	For the robot signal exchange proxy: <ul style="list-style-type: none"> • K2.X8 - A2.X6 • (option): K2.X2 - K4.X8, A2.X1 • K2.X12 - A2.K3.X6, A2.K3.X7 • K2.X10 - A1.X13 • K2.X21 - TempSensor • K2.X4 - A1.X9 • K2.X3 - K6.X1, A2.K3.X1, K5.1.X4, K7.X1 • K2.X1 - T2.X2 • K2.X17 - G2.X1, G1.X2 • K2.X6, K2.X11 - A1.X2 • K2.X7, K2.X22 - Harn. LV robot power • K2.X9 & X13 - FlexPendant 	
	For the Ethernet extension switch (option): <ul style="list-style-type: none"> • K2.X2 - K4.X8, A2.X1 • K4.X7 - K5.1.X5 • K4.X6 - A2.X4 	
	For the connected services gateway: <ul style="list-style-type: none"> • K7.X1 - K2.X3ⁱ • K7.X2 - A2.X5 <div style="margin-top: 10px;">  Note The connector K7.X2 is locked; grab the connector, push it in to release it and then remove the connector. </div>	
	For the main computer: <ul style="list-style-type: none"> • K2.X8 - A2.X6 • K2.X2 - K4.X8, A2.X1 • K2.X12 - A2.K3.X6, A2.K3.X7 • K6.X2 - A2.X9 • A2.X5 - K7.X2 • A2.X4 - K4.X6/K5.1.X5 <div style="margin-top: 10px;">  Note If the Ethernet extension switch is installed, connect and disconnect the connector A2.X4 to/from K4.X6. If the Ethernet extension switch is not installed, connect and disconnect the connector A2.X4 to/from K5.1.X5. </div>	

Continues on next page

5 Repair

5.2.9 Replacing the main computer

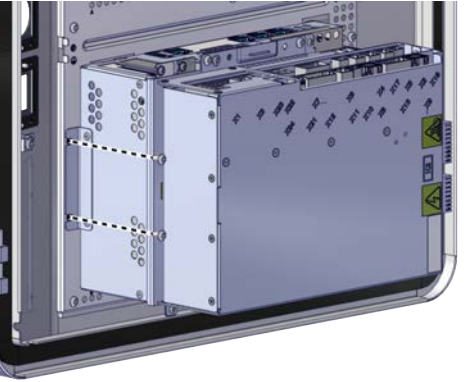
Continued

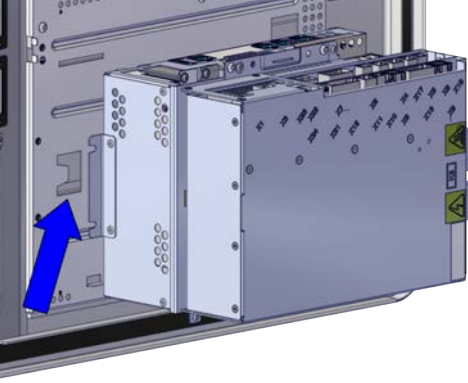
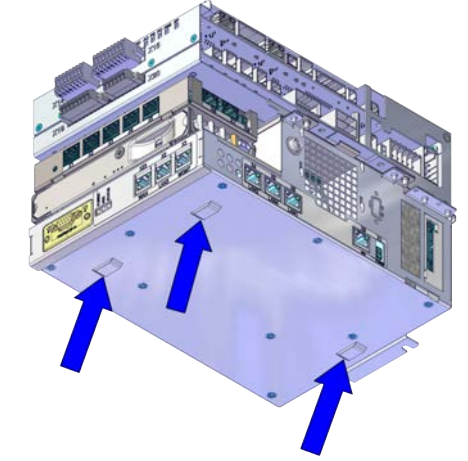
	Action	Note/Illustration
2	Remove the screws holding the main computer.	 <p>xx1900001877</p>
3	<p>Remove the assembly from the mounting plate.</p> <p> Note</p> <p>Avoid colliding with the frame when removing the unit.</p> <p> ELECTROSTATIC DISCHARGE (ESD)</p> <p>When handling the computer outside of the controller, use the wrist strap button located on the side of the computer.</p>	 <p>xx1900001878</p>  <p>xx1900001885</p>

ⁱ For connected services gateway wired, there is no power cable.

Continues on next page

Removing the robot signal exchange proxy

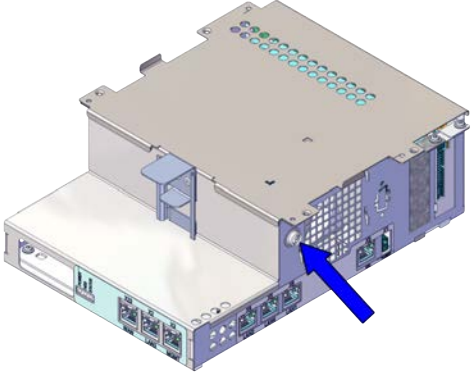
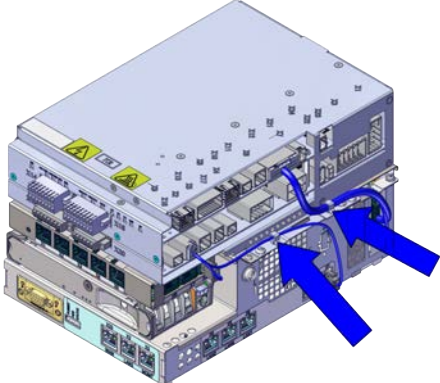
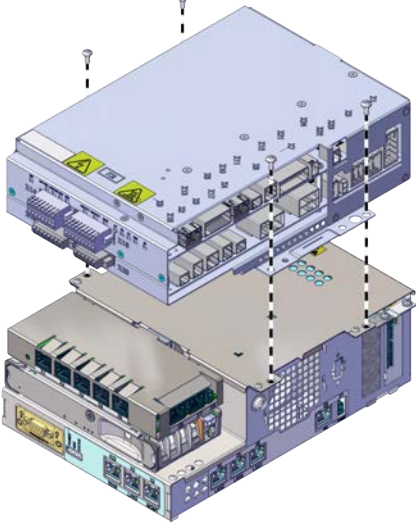
	Action	Note/Illustration
1	 <p>ELECTROSTATIC DISCHARGE (ESD)</p> <p>When handling the computer outside of the controller, use the wrist strap button located on the side of the computer.</p>	<p>Location of wrist strap button:</p>  <p>xx2000000419</p>
2	<p>Pull the cable ties out from the locking holes.</p>	 <p>xx1900001879</p>
3	<p>Remove the screws and lift out the robot signal exchange proxy.</p>	 <p>xx1900001880</p>

Continues on next page

5 Repair

5.2.9 Replacing the main computer

Continued

Removing the Ethernet extension switch (option)

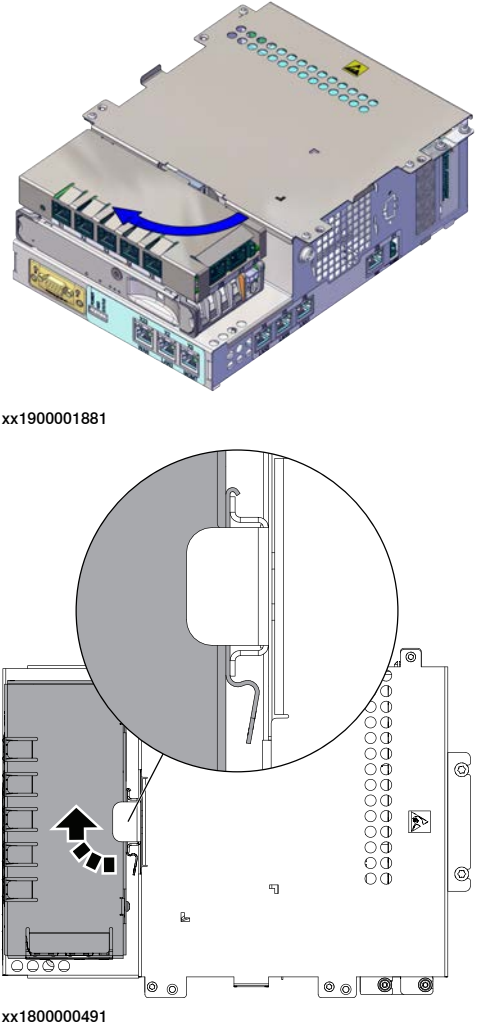
	Action	Note/Illustration
1	Carefully pull the side of the Ethernet extension switch and rotate it tightly to take it out from the bracket.	 <p>xx1900001881</p> <p>xx1800000491</p>

Continues on next page

Removing the connected services gateway

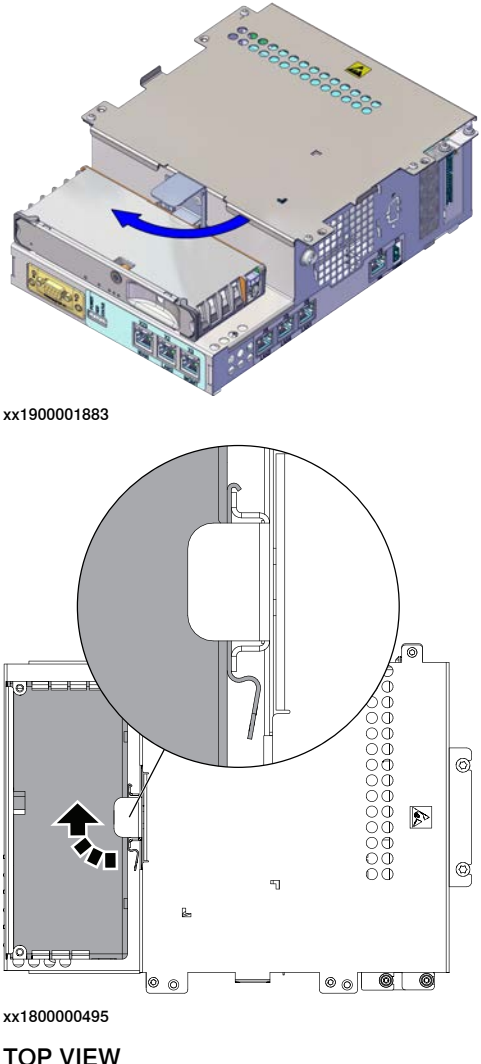
	Action	Note/Illustration
1	Carefully pull the side of the connected services gateway and rotate it tightly to take it out from the bracket.	 <p>xx1900001883</p> <p>xx1800000495</p> <p>TOP VIEW</p>

Refitting the main computer by assembly group

Refitting the connected services gateway



	Action	Note/Illustration
1	 <p>DANGER</p> <p>Before doing any work inside the cabinet, disconnect the mains power. For more information, see Electrical safety on page 31.</p>	

Continues on next page

5 Repair

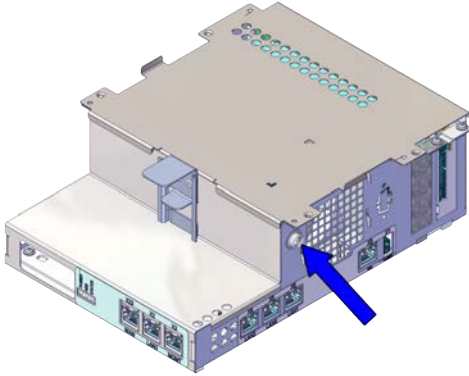

5.2.9 Replacing the main computer

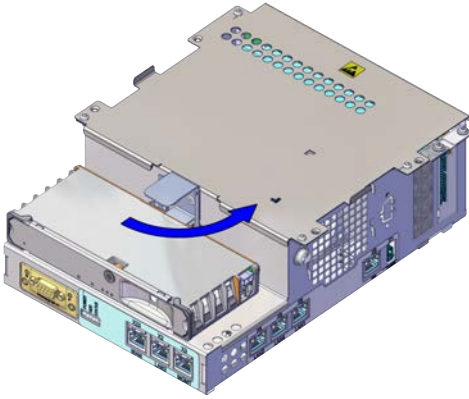
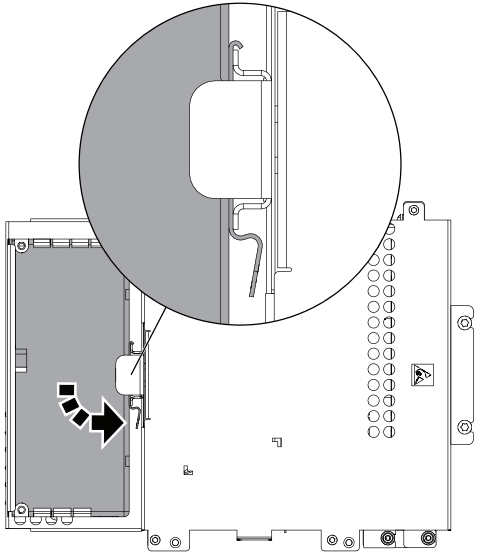
Continued

	Action	Note/Illustration
2	<p> ELECTROSTATIC DISCHARGE (ESD)</p> <p>The unit is sensitive to ESD. Before handling the unit read the safety information in section <i>The unit is sensitive to ESD on page 44.</i></p>	<p>Location of wrist strap button:</p>  <p>xx2000000419</p>
3	<p>Hook up the connected services gateway to the bracket and push carefully into position.</p> <p> Note</p> <p>During the installation, the gap between the lower surface of the connected services gateway and the upper surface of the main computer should be zero.</p>	 <p>xx1900001884</p>  <p>xx1800000497</p> <p>TOP VIEW</p>

Continues on next page

Refitting the Ethernet extension switch (option)

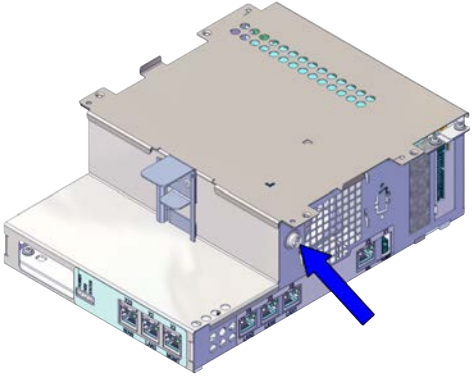
	Action	Note/Illustration
1	<p> DANGER</p> <p>Before doing any work inside the cabinet, disconnect the mains power. For more information, see Electrical safety on page 31.</p>	
2	<p> ELECTROSTATIC DISCHARGE (ESD)</p> <p>The unit is sensitive to ESD. Before handling the unit read the safety information in section The unit is sensitive to ESD on page 44.</p>	<p>Location of wrist strap button:</p>  <p>xx2000000419</p>

Continues on next page

5 Repair

5.2.9 Replacing the main computer

Continued

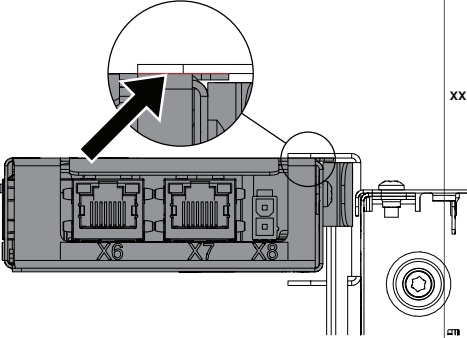
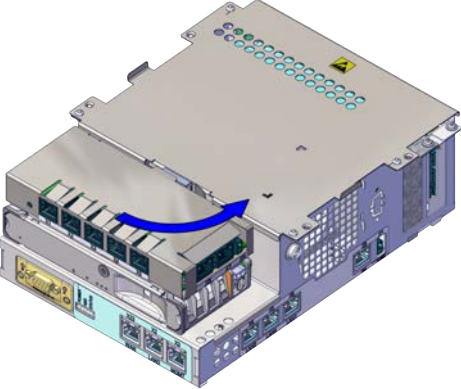
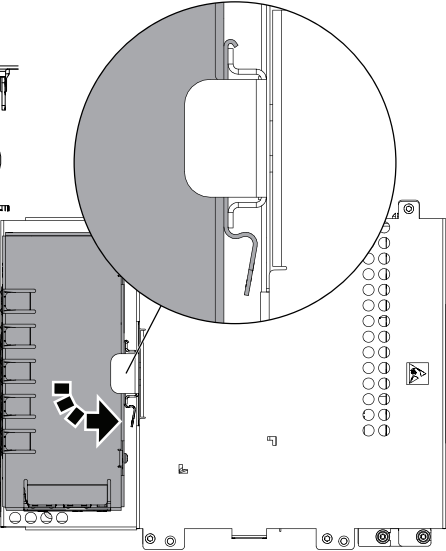
	Action	Note/Illustration
3	<p>Hook up the Ethernet extension switch to the bracket and then push the switch into position.</p> <p> Note</p> <p>During the installation, there should be no gap between the upper surface of the Ethernet extension switch and the lower surface of highest bracket on the main computer.</p>  <p>xx1800000972</p>	 <p>xx1900001882</p>  <p>xx1800000493</p>

Refitting the robot signal exchange proxy

	Action	Note/Illustration
1	<p> DANGER</p> <p>Before doing any work inside the cabinet, disconnect the mains power. For more information, see Electrical safety on page 31.</p>	

Continues on next page

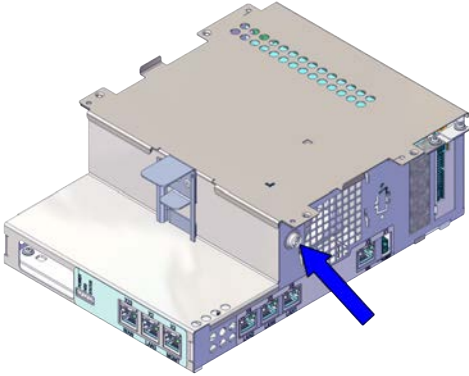
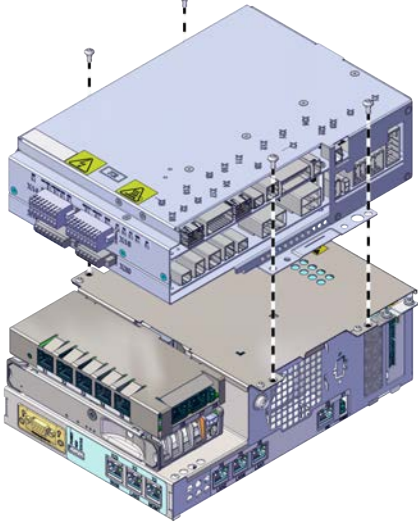
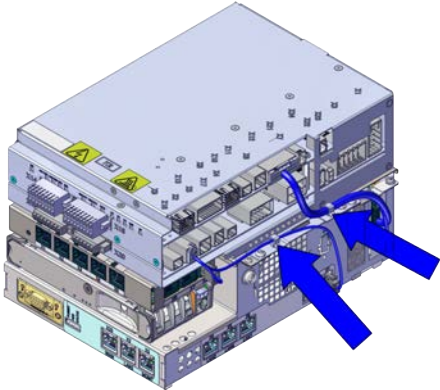
	Action	Note/Illustration
2	<p> ELECTROSTATIC DISCHARGE (ESD)</p> <p>The unit is sensitive to ESD. Before handling the unit read the safety information in section <i>The unit is sensitive to ESD on page 44</i>.</p>	<p>Location of wrist strap button:</p>  <p>xx2000000419</p>
3	<p>Fit the robot signal exchange proxy and secure the screws.</p>	<p>Screws: Torx pan head screw M4x8 (4 pcs) Tightening torque: 1.7 Nm±10%.</p>  <p>xx1900001880</p>
4	<p>Insert the cable ties into the locking holes.</p>	 <p>xx1900001879</p>



Continues on next page

5 Repair

5.2.9 Replacing the main computer

Continued

Refitting the main computer assembly to the cabinet

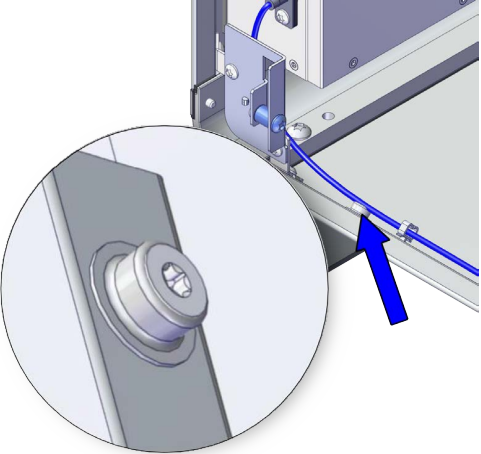
	Action	Note/Illustration
1	 DANGER Before doing any work inside the cabinet, disconnect the mains power. For more information, see Electrical safety on page 31 .	
2	 ELECTROSTATIC DISCHARGE (ESD) When handling the computer outside of the controller, use the wrist strap button located on the side of the computer.	Location of wrist strap button:  xx1900001446

Continues on next page

5.2.9 Replacing the main computer
Continued

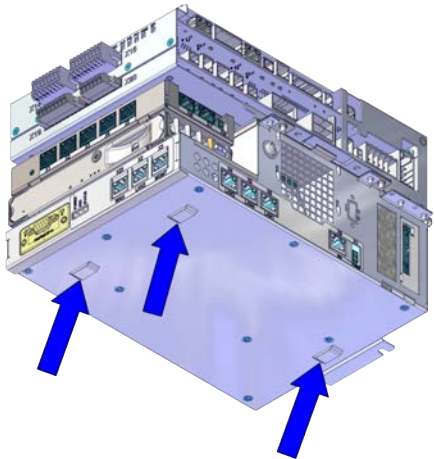
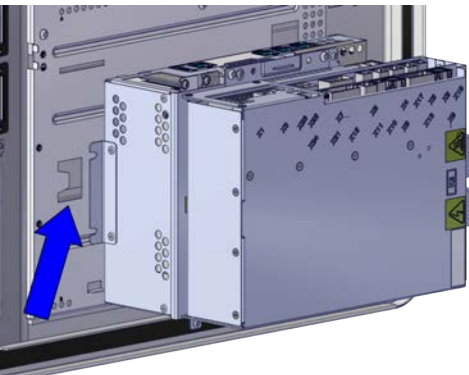
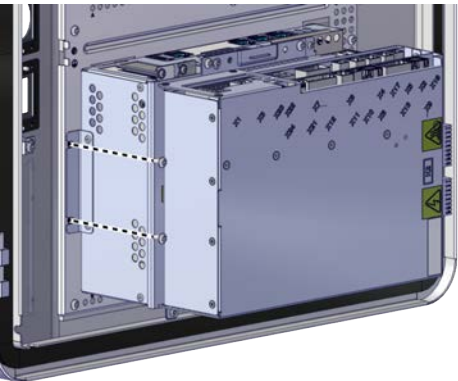

	Action	Note/Illustration
3	Refit the assembly onto the mounting plate.	 <p>xx1900001885</p>  <p>xx1900001878</p>
4	Fasten the assembly with the screws.	 <p>xx1900001877</p>
5	Reconnect all the connectors on assembly of the robot signal exchange proxy, ethernet extension-seven port switch (option), ABB ability™ connected services, and main computer.	

Continues on next page

5 Repair

5.2.9 Replacing the main computer

Continued

Action	Note/Illustration
<p>For the robot signal exchange proxy:</p> <ul style="list-style-type: none"> • K2.X8 - A2.X6 • (option): K2.X2 - K4.X8, A2.X1 • K2.X12 - A2.K3.X6, A2.K3.X7 • K2.X10 - A1.X13 • K2.X21 - TempSensor (G3.TEMP) • K2.X4 - A1.X9 • K2.X3 - K6.X1, A2.K3.X1, K5.1.X4, K7.X1 • K2.X1 - T2.X2 • K2.X17 - G3.X1, G1.X2 • K2.X6, K2.X11 - A1.X2 • K2.X7, K2.X22 - Harn. LV robot power (X1) • K2.X9 & X13 - FlexPendant (X4) 	
<p>For the Ethernet extension switch (option):</p> <ul style="list-style-type: none"> • K2.X2 - K4.X8, A2.X1 • K4.X7 - K5.1.X5 • K4.X6 - A2.X4 	
<p>For the connected services gateway:</p> <ul style="list-style-type: none"> • K7.X1 - K2.X3ⁱ • K7.X2 - A2.X5 <p> Note</p> <p>The connector K7.X2 is locked; grab the connector, push it in to release it and then remove the connector.</p>	
<p>For the main computer:</p> <ul style="list-style-type: none"> • A2.X3 - X24 • K2.X8 - A2.X6 • K2.X2 - K4.X8, A2.X1 • K2.X12 - A2.K3.X6, A2.K3.X7 • K6.X2 - A2.X9 • A2.X5 - K7.X2 • A2.X4 - K4.X6/K5.1.X5 <p> Note</p> <p>If the Ethernet extension switch is installed, connect and disconnect the connector A2.X4 to/from K4.X6.</p> <p>If the Ethernet extension switch is not installed, connect and disconnect the connector A2.X4 to/from K5.1.X5.</p>	

ⁱ For connected services gateway wired, there is no power cable.



Continues on next page

Concluding procedure

	Action	Note/Illustration
1	Close the door.	Closing the door on page 188.
2	Restore the hardware settings.	Restoring the hardware settings on page 271.
3	Create an installation package based on a local backup to restore the RobotWare system.	<i>Operating manual - Integrator's guide OmniCore, section Installing a new RobotWare system.</i>
4	Restore user configuration and RAPID programs from the backup.	<i>Operating manual - Integrator's guide OmniCore, section Backup and restore systems.</i>
5	Perform the function tests to verify that the safety features work properly.	Function tests on page 178.

Removing the main computer by parts

Preparations

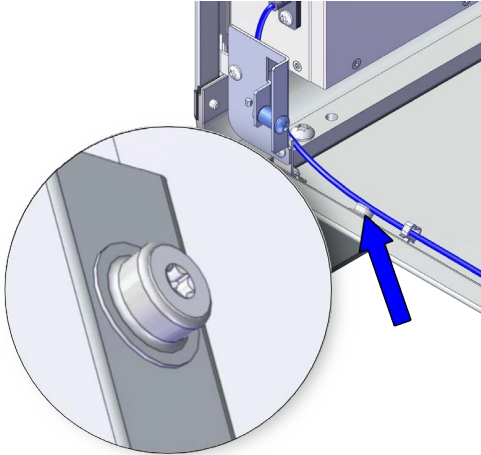
	Action	Note/Illustration
1	 DANGER Before doing any work inside the cabinet, disconnect the mains power. For more information, see Electrical safety on page 31.	
2	Open the door.	Opening the door on page 188.
3	 ELECTROSTATIC DISCHARGE (ESD) The unit is sensitive to ESD. Before handling the unit read the safety information in section The unit is sensitive to ESD on page 44.	Location of wrist strap button:  xx1900001446

Disconnecting the connectors to the main computer assembly



	Action	Note/Illustration
1	Disconnect all the connectors on the assembly group of the robot signal exchange proxy, Ethernet switch (option), connected services gateway, scalable I/O (option), and main computer.	

Continues on next page

5 Repair

5.2.9 Replacing the main computer

Continued

Action	Note/Illustration
<p>For the robot signal exchange proxy:</p> <ul style="list-style-type: none"> • K2.X8 - A2.X6 • (option): K2.X2 - K4.X8, A2.X1 • K2.X12 - A2.K3.X6, A2.K3.X7 • K2.X10 - A1.X13 • K2.X21 - TempSensor (G3.TEMP) • K2.X4 - A1.X9 • K2.X3 - K6.X1, A2.K3.X1, K5.1.X4, K7.X1 • K2.X1 - T2.X2 • K2.X17 - G3.X1, G1.X2 • K2.X6, K2.X11 - A1.X2 • K2.X7, K2.X22 - Harn. LV robot power (X1) • K2.X9 & X13 - FlexPendant (X4) 	
<p>For the Ethernet extension switch:</p> <ul style="list-style-type: none"> • K2.X2 - K4.X8, A2.X1 • K4.X7 - K5.1.X5 • K4.X6 - A2.X4 	
<p>For the connected services gateway:</p> <ul style="list-style-type: none"> • K7.X1 - K2.X3ⁱ • K7.X2 - A2.X5 <p> Note</p> <p>The connector K7.X2 is locked; grab the connector, push it in to release it and then remove the connector.</p>	
<p>For the main computer:</p> <ul style="list-style-type: none"> • A2.X3 - X24 • K2.X8 - A2.X6 • K2.X2 - K4.X8, A2.X1 • K2.X12 - A2.K3.X6, A2.K3.X7 • K6.X2 - A2.X9 • A2.X5 - K7.X2 • A2.X4 - K4.X6/K5.1.X5 <p> Note</p> <p>If the Ethernet extension switch is installed, connect and disconnect the connector A2.X4 to/from K4.X6.</p> <p>If the Ethernet extension switch is not installed, connect and disconnect the connector A2.X4 to/from K5.1.X5.</p>	

ⁱ For Connected Services Gateway wired, there is no power cable.

Continues on next page

Removing the robot signal exchange proxy

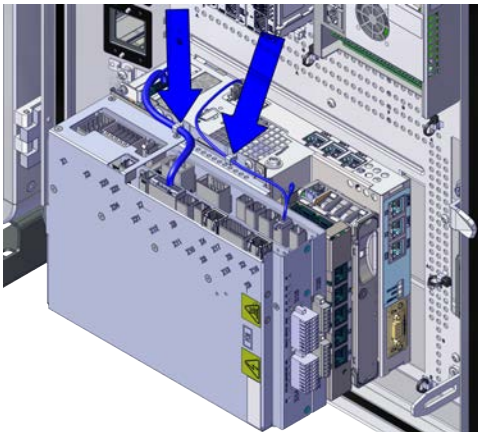
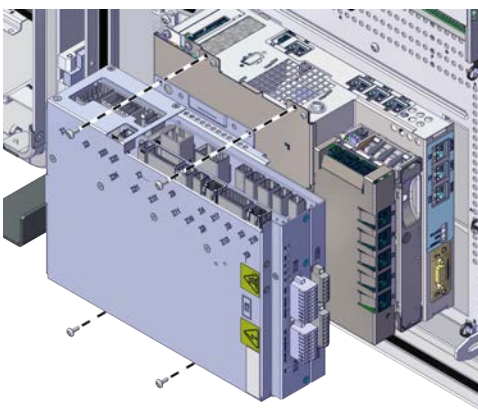
	Action	Note/Illustration
1	Pull the cable ties out from the locking holes.	 <p>xx1900001886</p>
2	Remove the screws and lift out the robot signal exchange proxy.	 <p>xx1900001887</p>

Continues on next page

5 Repair

5.2.9 Replacing the main computer

Continued

Removing the Ethernet extension switch (option)

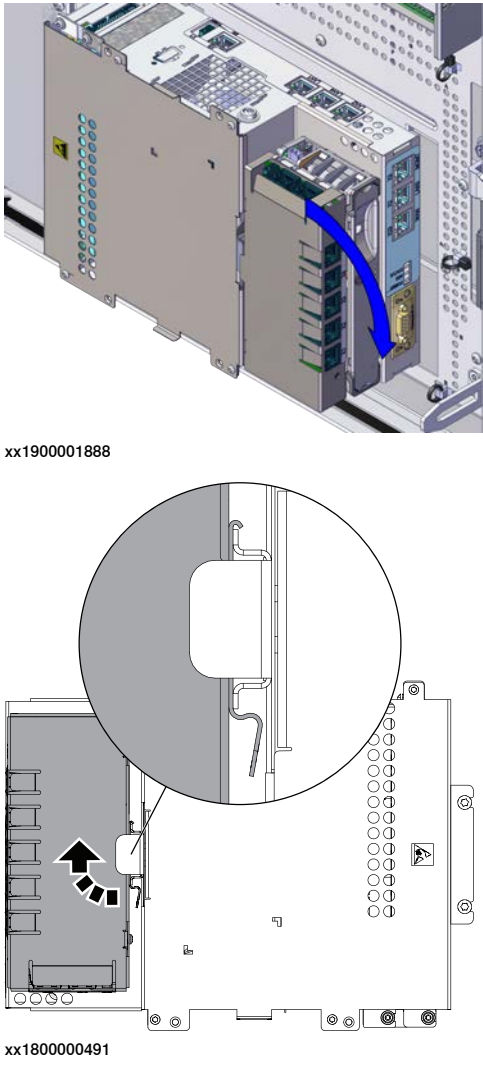
	Action	Note/Illustration
1	Carefully pull the side of the Ethernet extension switch and rotate it tightly to take it out from the bracket.	 <p>xx1900001888</p> <p>xx180000491</p>

Continues on next page

Removing the connected services gateway

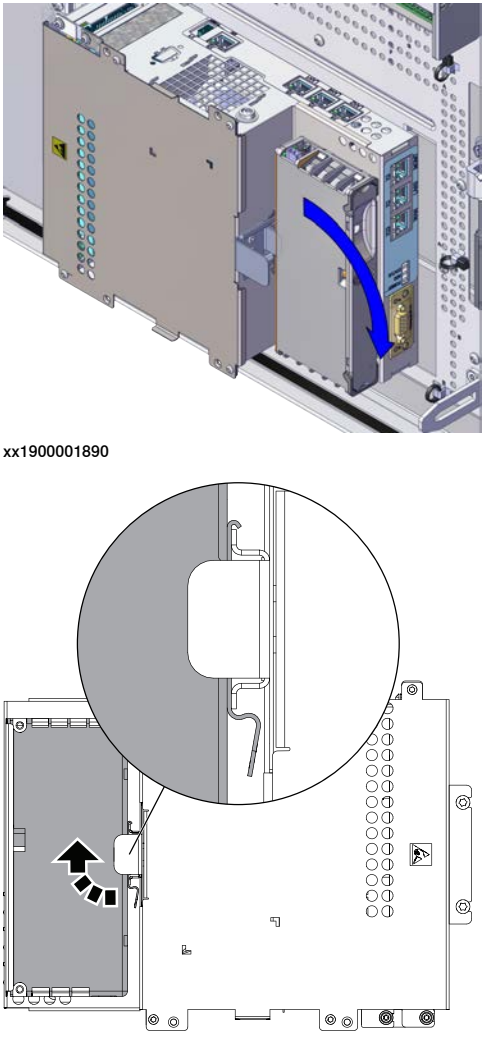
	Action	Note/Illustration
1	Carefully pull the side of the connected services gateway and rotate it tightly to take it out from the bracket.	 <p>xx1900001890</p> <p>xx1800000495</p> <p>TOP VIEW</p>



Continues on next page

5 Repair

5.2.9 Replacing the main computer

Continued

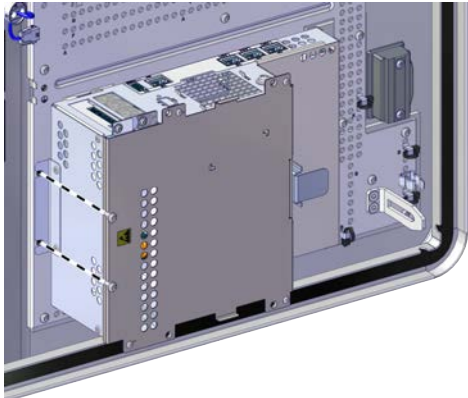

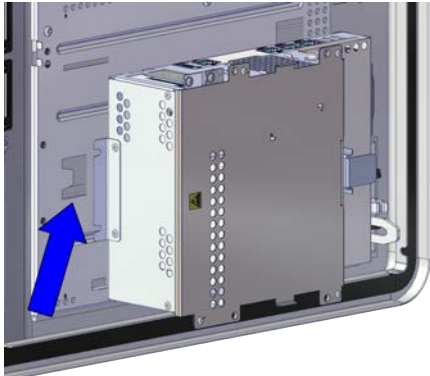
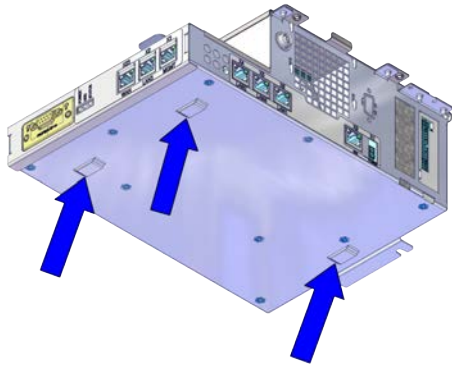
Removing the main computer

	Action	Note/Illustration
1	Remove the screws holding the main computer.	 <p>xx1900001892</p>
2	<p>Remove the main computer.</p> <p> ELECTROSTATIC DISCHARGE (ESD)</p> <p>When handling the computer outside of the controller, use the wrist strap button located on the side of the computer.</p>	 <p>xx1900001893</p>  <p>xx1900001894</p>

Continues on next page

Refitting the main computer by parts

Refitting the main computer

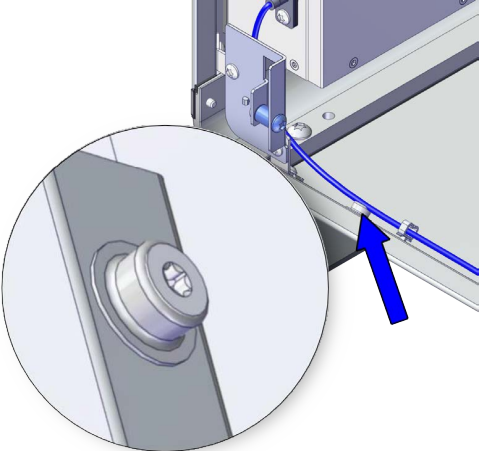
	Action	Note/Illustration
1	 <p>DANGER</p> <p>Before doing any work inside the cabinet, disconnect the mains power. For more information, see Electrical safety on page 31.</p>	
2	 <p>ELECTROSTATIC DISCHARGE (ESD)</p> <p>The unit is sensitive to ESD. Before handling the unit read the safety information in section The unit is sensitive to ESD on page 44.</p>	<p>Location of wrist strap button:</p>  <p>xx1900001446</p>

Continues on next page

5 Repair

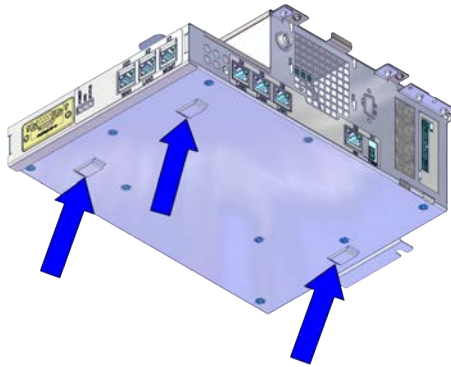
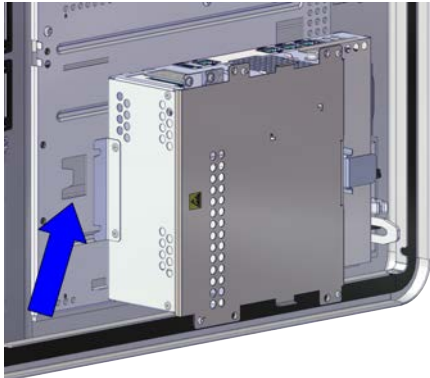
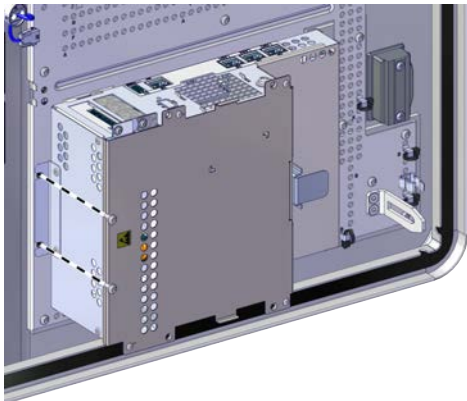

5.2.9 Replacing the main computer

Continued

	Action	Note/Illustration
3	Fit the main computer to the mounting plate.	 <p>xx1900001894</p>  <p>xx1900001893</p>
4	Fasten the main computer with the screws.	<p>Screws: Torx pan head screw M4x8 (2 pcs) Tightening torque: 1.7 Nm±10%.</p>  <p>xx1900001892</p>

Continues on next page

Refitting the connected services gateway

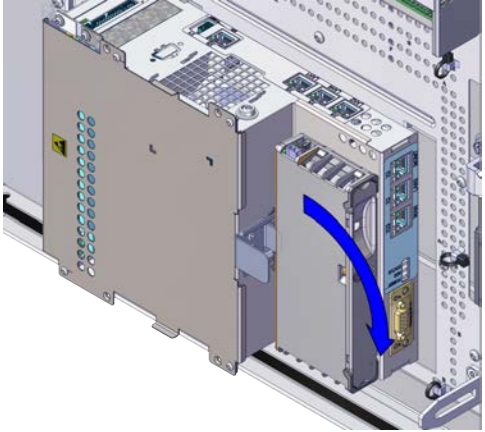
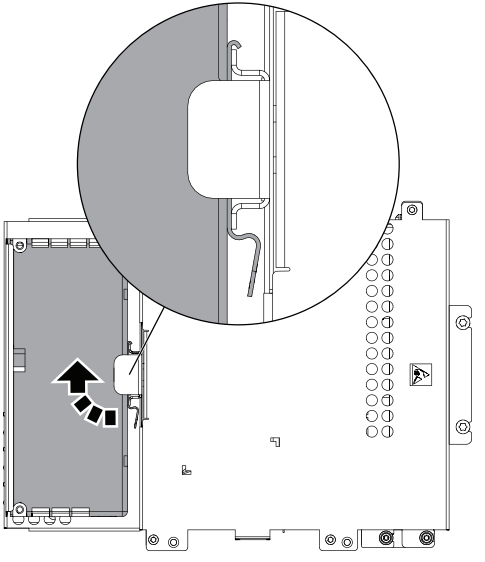
	Action	Note/Illustration
1	<p> DANGER</p> <p>Before doing any work inside the cabinet, disconnect the mains power. For more information, see Electrical safety on page 31.</p>	
2	<p> ELECTROSTATIC DISCHARGE (ESD)</p> <p>The unit is sensitive to ESD. Before handling the unit read the safety information in section The unit is sensitive to ESD on page 44.</p>	
3	<p>Hook up the connected services gateway to the bracket and push carefully into position.</p> <p> Note</p> <p>During the installation, the gap between the lower surface of the Connected Services Gateway and the upper surface of the main computer should be zero.</p>	 <p>xx1900001890</p>  <p>xx1800000495</p> <p>TOP VIEW</p>



Continues on next page

5 Repair

5.2.9 Replacing the main computer

Continued

Refitting the Ethernet extension switch (option)

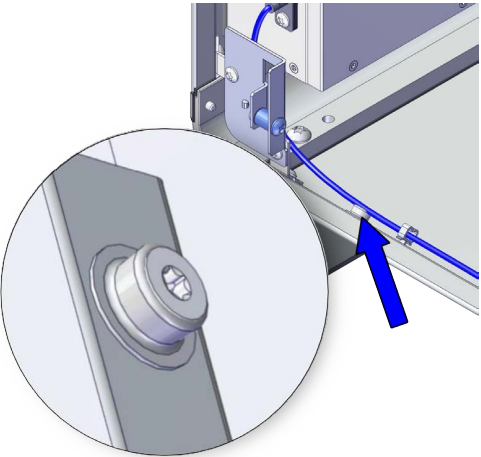
	Action	Note/Illustration
1	 DANGER Before doing any work inside the cabinet, disconnect the mains power. For more information, see Electrical safety on page 31 .	
2	 ELECTROSTATIC DISCHARGE (ESD) The unit is sensitive to ESD. Before handling the unit read the safety information in section The unit is sensitive to ESD on page 44 .	<p>Location of wrist strap button:</p>  <p>xx1900001446</p>

Continues on next page

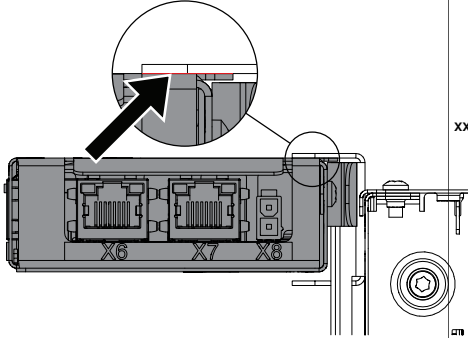
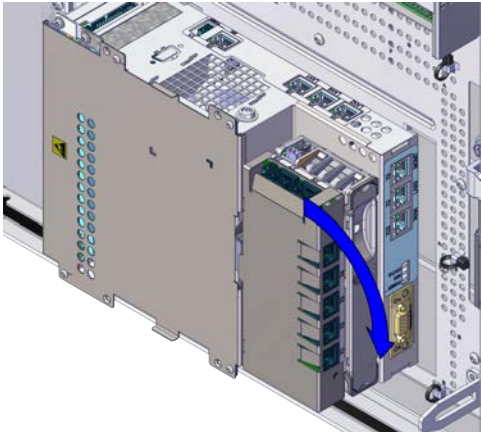
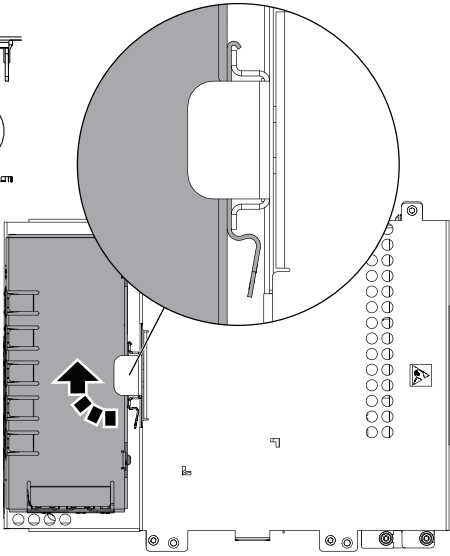
	Action	Note/Illustration
3	<p>Hook up the Ethernet extension switch to the bracket and then push the switch into position.</p> <p> Note</p> <p>During the installation, there should be no gap between the upper surface of the Ethernet extension switch and the lower surface of highest bracket on the main computer.</p>  <p>xx1800000972</p>	 <p>xx1900001888</p>  <p>xx1800000491</p>

Refitting the robot signal exchange proxy

	Action	Note/Illustration
1	<p> DANGER</p> <p>Before doing any work inside the cabinet, disconnect the mains power. For more information, see Electrical safety on page 31.</p>	

Continues on next page

5 Repair

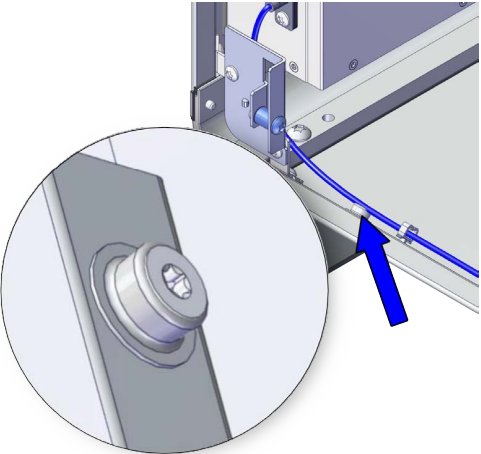
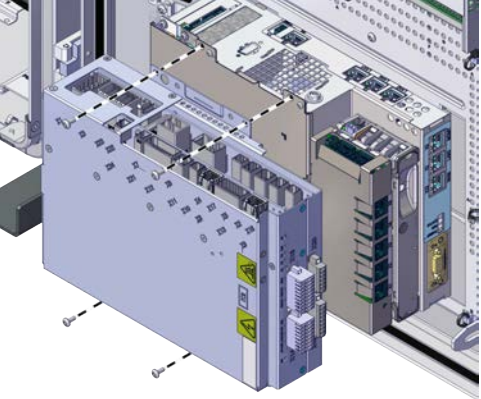
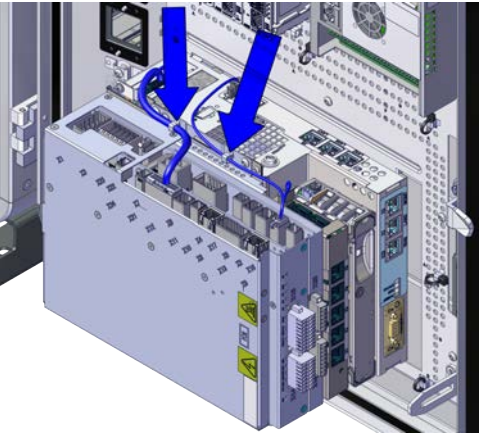

5.2.9 Replacing the main computer

Continued

	Action	Note/Illustration
2	<p> ELECTROSTATIC DISCHARGE (ESD)</p> <p>The unit is sensitive to ESD. Before handling the unit read the safety information in section <i>The unit is sensitive to ESD on page 44</i>.</p>	<p>Location of wrist strap button:</p>  <p>xx1900001446</p>
3	<p>Fit the robot signal exchange proxy and secure the screws.</p>	<p>Screws: Torx pan head screw M4x8 (4 pcs) Tightening torque: 1.7 Nm±10%.</p>  <p>xx1900001887</p>
4	<p>Insert the cable ties into the locking holes.</p>	 <p>xx1900001886</p>

Continues on next page

Reconnecting the connectors to the main computer assembly

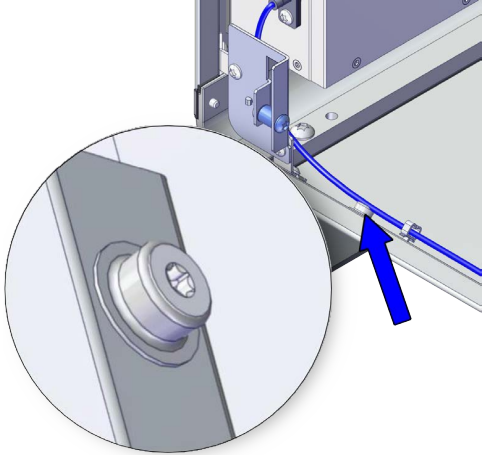

	Action	Note/Illustration
1	 <p>DANGER</p> <p>Before doing any work inside the cabinet, disconnect the mains power. For more information, see Electrical safety on page 31.</p>	
2	 <p>ELECTROSTATIC DISCHARGE (ESD)</p> <p>When handling the computer outside of the controller, use the wrist strap button located on the side of the computer.</p>	<p>Location of wrist strap button:</p>  <p>xx1900001446</p>
3	<p>Reconnect all the connectors on assembly of the robot signal exchange proxy, ethernet extension-seven port switch (option), ABB ability™ connected services, scalable I/O digital base (option), and main computer.</p> <p>For the robot signal exchange proxy:</p> <ul style="list-style-type: none"> • K2.X8 - A2.X6 • (option): K2.X2 - K4.X8, A2.X1 • K2.X12 - A2.K3.X6, A2.K3.X7 • K2.X10 - A1.X13 • K2.X21 - TempSensor (G3.TEMP) • K2.X4 - A1.X9 • K2.X3 - K6.X1, A2.K3.X1, K5.1.X4, K7.X1 • K2.X1 - T2.X2 • K2.X17 - G3.X1, G1.X2 • K2.X6, K2.X11 - A1.X2 • K2.X7, K2.X22 - Harn. LV robot power (X1) • K2.X9 & X13 - FlexPendant (X4) <p>For the Ethernet extension switch:</p> <ul style="list-style-type: none"> • K2.X2 - K4.X8, A2.X1 • K4.X7 - K5.1.X5 • K4.X6 - A2.X4 	

Continues on next page

5 Repair

5.2.9 Replacing the main computer

Continued

Action	Note/Illustration
<p>For the connected services gateway:</p> <ul style="list-style-type: none"> • K7.X1 - K2.X3ⁱ • K7.X2 - A2.X5 <p> Note</p> <p>The connector K7.X2 is locked; grab the connector, push it in to release it and then remove the connector.</p>	
<p>For the main computer:</p> <ul style="list-style-type: none"> • A2.X3 - X24 • K2.X8 - A2.X6 • K2.X2 - K4.X8, A2.X1 • K2.X12 - A2.K3.X6, A2.K3.X7 • K6.X2 - A2.X9 • A2.X5 - K7.X2 • A2.X4 - K4.X6/K5.1.X5 <p> Note</p> <p>If the Ethernet extension switch is installed, connect and disconnect the connector A2.X4 to/from K4.X6.</p> <p>If the Ethernet extension switch is not installed, connect and disconnect the connector A2.X4 to/from K5.1.X5.</p>	

ⁱ For Connected Services Gateway wired, there is no power cable.

Concluding procedure

	Action	Note/Illustration
1	Close the door.	Closing the door on page 188.
2	Restore the hardware settings.	Restoring the hardware settings on page 271.
3	Create an installation package based on a local backup to restore the RobotWare system.	<i>Operating manual - Integrator's guide OmniCore</i> , section <i>Installing a new RobotWare system</i> .
4	Restore user configuration and RAPID programs from the backup.	<i>Operating manual - Integrator's guide OmniCore</i> , section <i>Backup and restore systems</i> .
5	Perform the function tests to verify that the safety features work properly.	Function tests on page 178.



Continues on next page

Restoring the hardware settings

The controller hardware settings include information such as controller type and serial number. When the main computer has been replaced, the serial number must be restored before any software can be installed, or any licences can be imported.

**Note**

When replacing the main computer, both the serial number and licences are lost. The serial number must be restored as described below. Licences however, can either be restored automatically when the RobotWare system is installed, or manually through **Manage Licences** in RobotWare Installation Utilities.

	Action	Note/Illustration
1	Download the hardware information file (hwsettings.rsf) from MyABB, or from a previous system backup.	
2	Access the RobotWare Installation Utilities.	 xx1900000110
3	Tap Advanced , and then Restore Hardware Settings .	
4	The Restore Hardware Settings window is displayed. Follow the instructions and tap Next to proceed.	
5	Carefully read the information and then check all boxes to confirm that you agree with the ABB conditions. Tap Next to proceed.	
6	Read the serial number on the front of the controller and type it in field Serial Number . Tap Next .	 xx2000000007
7	Tap Browse to open the hardware information file from its location. The restoration of the serial number is completed.	The system compares the downloaded file and the manually entered serial number to ensure that there is a match.

5 Repair

5.2.10 Replacing the power unit

5.2.10 Replacing the power unit

Location

The illustration shows the location of the power unit in the controller.

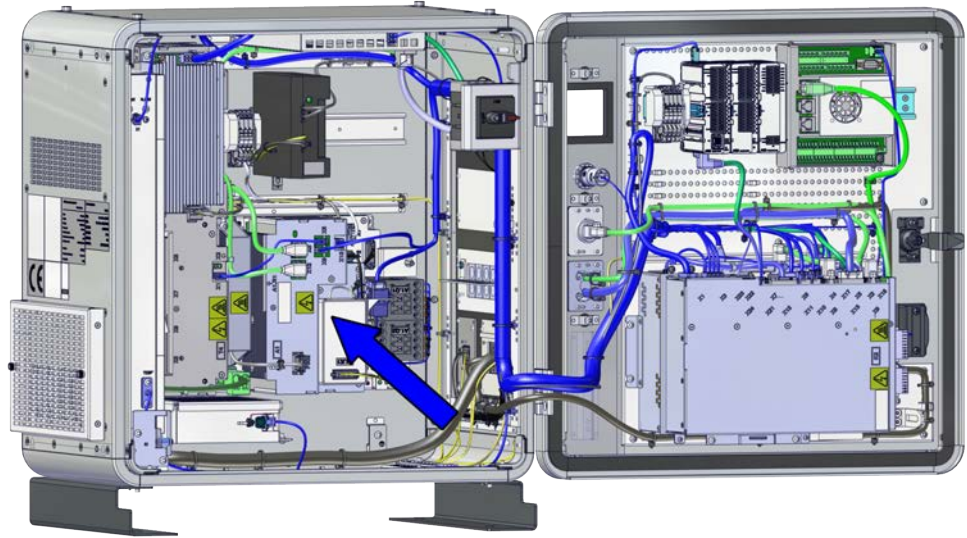

xx1900001469

Required spare parts



Note

The spare part numbers that are listed in the table can be out of date. See the latest spare parts of the OmniCore C90XT via myABB Business Portal, www.abb.com/myABB.

Spare part	Article number	Note
Power unit	3HAC059152-001	DSQC3044

Required tools and equipment

Equipment	Article number	Note
Standard toolkit	-	Content is defined in section Standard toolkit for controller on page 448 .
ESD protective wrist band	-	



Required documents

Document	Article number	Note
<i>Circuit diagram - OmniCore C90XT</i>	3HAC065464-009	

Continues on next page

Removing the power unit

Preparations

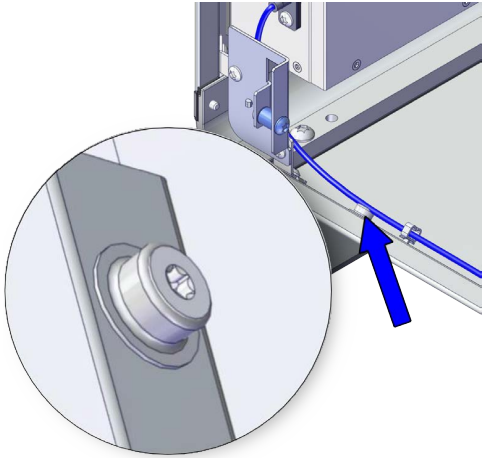
	Action	Note/Illustration
1	 DANGER Before doing any work inside the cabinet, disconnect the mains power. For more information, see Electrical safety on page 31 .	
2	Open the door.	Opening the door on page 188 .
3	 ELECTROSTATIC DISCHARGE (ESD) The unit is sensitive to ESD. Before handling the unit read the safety information in section The unit is sensitive to ESD on page 44 .	Location of wrist strap button:  xx1900001446

Removing the power unit

	Action	Note/Illustration
1	Disconnect: <ul style="list-style-type: none"> • A1.X13 - K2.X10 • A1.X9 - K2.X4 • A1.X4 - T4.X5 • A1.X5 - T4.X1 • A1.X12 - T4.X3 • A1.X1 - Incoming mains (X0) • A1.X6 A1.X7-T2.X1 and AC Terminal block 	

Continues on next page

5 Repair

5.2.10 Replacing the power unit

Continued

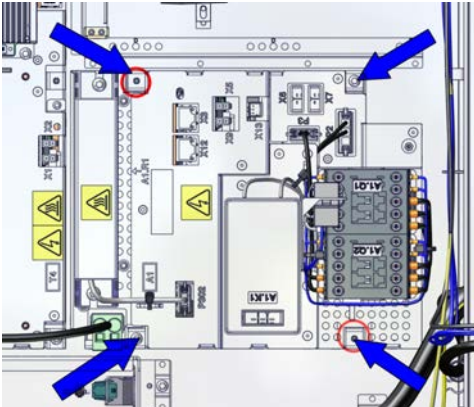
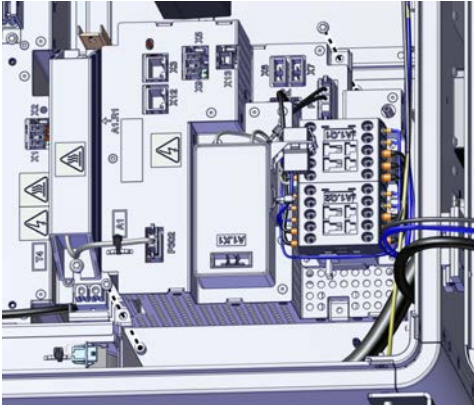
	Action	Note/Illustration
2	<p>Remove the screws and pull the power unit out from the two snaps on the mounting plate.</p> <p> CAUTION</p> <p>Only the sheet metal on the power unit can be used for holding.</p> <p>Do not touch the connectors or the filter on the power unit.</p>	 <p>xx1900001895</p>  <p>xx1900001896</p>

Refitting the power unit

Refitting the power unit

	Action	Note/Illustration
1	<p> DANGER</p> <p>Before doing any work inside the cabinet, disconnect the mains power. For more information, see Electrical safety on page 31.</p>	

Continues on next page

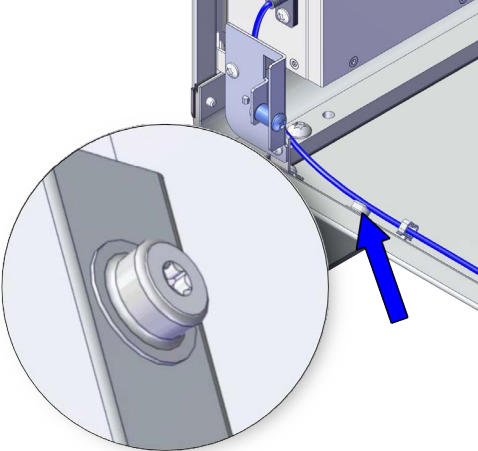
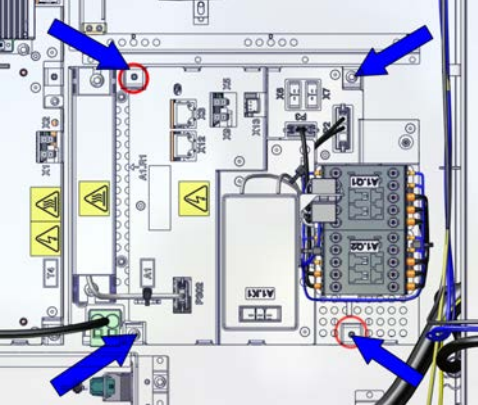
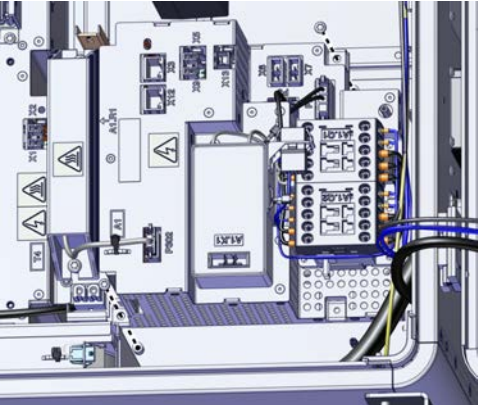
	Action	Note/Illustration
2	<p> ELECTROSTATIC DISCHARGE (ESD)</p> <p>The unit is sensitive to ESD. Before handling the unit read the safety information in section <i>The unit is sensitive to ESD on page 44.</i></p>	<p>Location of wrist strap button:</p>  <p>xx1900001446</p>
3	<p>Push the power unit until it snaps on the mounting plate and secure the screws.</p>	<p>Screws: Torx pan head screw M4x8 (2 pcs) Tightening torque: 1.7 Nm±10%.</p>  <p>xx1900001895</p>  <p>xx1900001896</p>

Continues on next page

5 Repair

5.2.10 Replacing the power unit

Continued

	Action	Note/Illustration
4	Reconnect: <ul style="list-style-type: none">• A1.X13 - K2.X10• A1.X9 - K2.X4• A1.X4 - T4.X5• A1.X5 - T4.X1• A1.X12 - T4.X3• A1.X1 - Incoming mains (X0)• A1.X6 A1.X7-T2.X1 and AC Terminal block	

Concluding procedure

	Action	Note/Illustration
1	Close the door.	Closing the door on page 188.
2	Perform the function tests to verify that the safety features work properly, see Function tests on page 178.	

5.2.11 Replacing the power supply

Location

The illustration shows the location of the power supply in the controller.

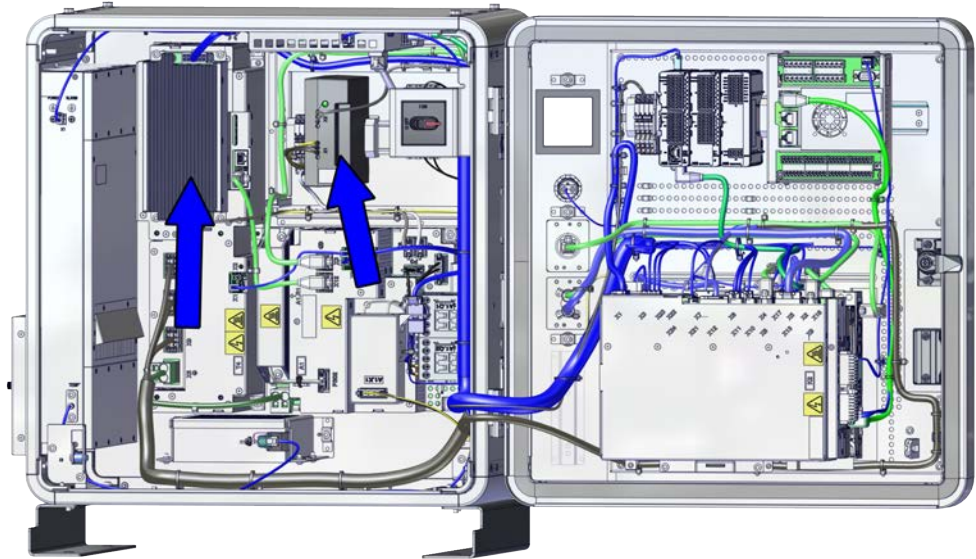

xx1900001470



WARNING

Do not touch the power supply when the DC OK LED is on.

There is residual voltage in the power supply even if the main switch is in the OFF position.

Required spare parts



Note

The spare part numbers that are listed in the table can be out of date. See the latest spare parts of the OmniCore C90XT via myABB Business Portal, www.abb.com/myABB.

Spare part	Article number	Note
Power supply	3HAC071301-001	DSQC3035
DSQC 609 power supply	3HAC14178-1	DSQC 609
DSQC 634 power supply	3HAC13398-2	DSQC 634
Harness AC input of power supply	3HAC069617-001	
End clamp	3HAB7983-1	

Continues on next page

5 Repair

5.2.11 Replacing the power supply

Continued

Required tools and equipment



Equipment	Article number	Note
Standard toolkit	-	Content is defined in section Standard toolkit for controller on page 448 .
ESD protective wrist band	-	

Required documents

Document	Article number	Note
<i>Circuit diagram - OmniCore C90XT</i>	3HAC065464-009	

Removing the power supply baseline

Preparations

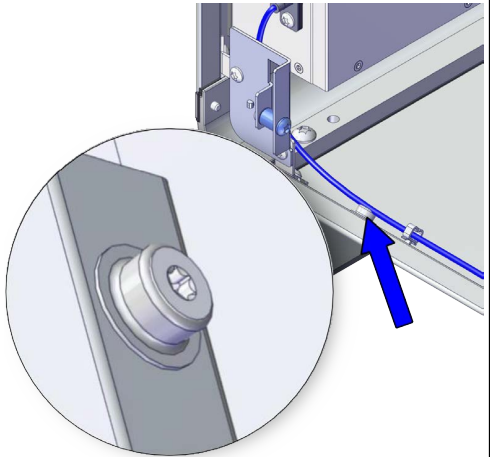
	Action	Note/Illustration
1	 DANGER Before doing any work inside the cabinet, disconnect the mains power. For more information, see Electrical safety on page 31 .	
2	Open the door.	Opening the door on page 188 .
3	 ELECTROSTATIC DISCHARGE (ESD) The unit is sensitive to ESD. Before handling the unit read the safety information in section The unit is sensitive to ESD on page 44 .	Location of wrist strap button:  xx1900001446

Removing the power supply baseline

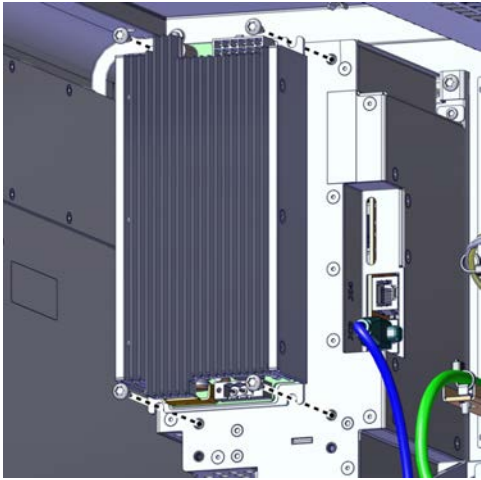

	Action	Note/Illustration
1	Disconnect: <ul style="list-style-type: none"> • T2.X1 - A1.X6 • T2.X2 - K2.X1 	

Continues on next page

	Action	Note/Illustration
2	Remove the screws and the power supply.	 <p>xx1900001897</p>

Refitting the power supply baseline

Refitting the power supply

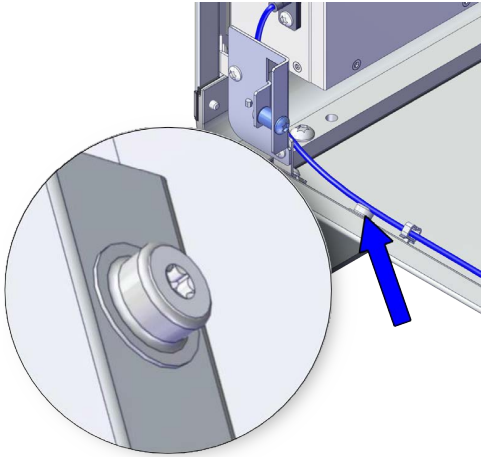
	Action	Note/Illustration
1	 <p>DANGER</p> <p>Before doing any work inside the cabinet, disconnect the mains power. For more information, see Electrical safety on page 31.</p>	
2	 <p>ELECTROSTATIC DISCHARGE (ESD)</p> <p>The unit is sensitive to ESD. Before handling the unit read the safety information in section The unit is sensitive to ESD on page 44.</p>	<p>Location of wrist strap button:</p>  <p>xx1900001446</p>

Continues on next page

5 Repair

5.2.11 Replacing the power supply

Continued

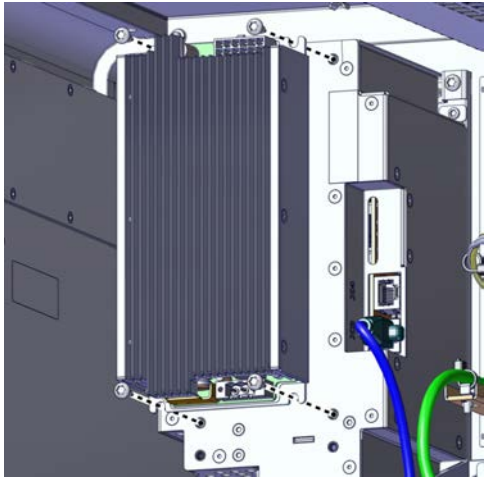
	Action	Note/Illustration
3	Fit the power supply and fasten it with screws.	<p>Screws: Torx pan head screw M4x8 (4 pcs) Tightening torque: 1.7 Nm±10%.</p>  <p>xx1900001897</p>
4	Reconnect and secure: <ul style="list-style-type: none"> • T2.X1 - A1.X6 • T2.X2 - K2.X1. 	

Concluding procedure

	Action	Note/Illustration
1	Close the door.	Closing the door on page 188.
2	Perform the function tests to verify that the safety features work properly, see Function tests on page 178.	

Removing the DSQC 609 power supply

Preparations

	Action	Note/Illustration
1	 DANGER Before doing any work inside the cabinet, disconnect the mains power. For more information, see Electrical safety on page 31.	
2	Open the door.	Opening the door on page 188.

Continues on next page

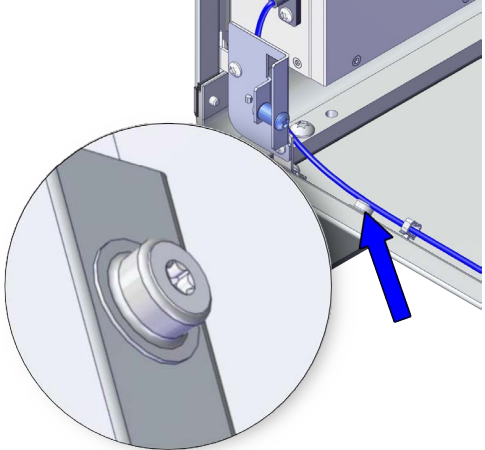
	Action	Note/Illustration
3	<p> ELECTROSTATIC DISCHARGE (ESD)</p> <p>The unit is sensitive to ESD. Before handling the unit read the safety information in section <i>The unit is sensitive to ESD on page 44.</i></p>	<p>Location of wrist strap button:</p>  <p>xx1900001446</p>

Removing the power supply

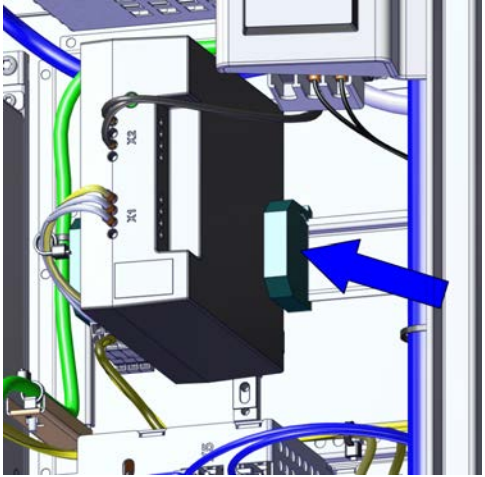
	Action	Note/Illustration
1	<p>Remove the end clamp besides the power supply with a screwdriver.</p>	 <p>xx1900001907</p>

Continues on next page

5 Repair

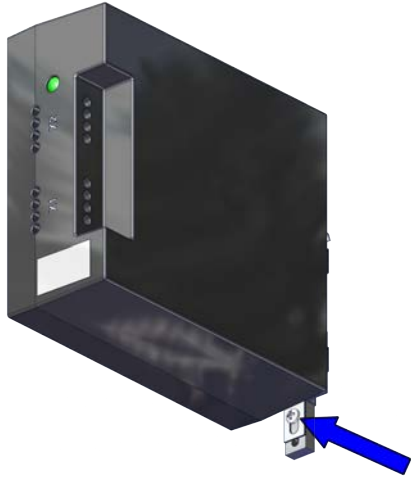

5.2.11 Replacing the power supply

Continued

	Action	Note/Illustration
2	Disconnect: <ul style="list-style-type: none"> • T5.X1-AC Terminal block • T5.X2-24V Terminal block 	 <p>xx1900001908</p>
3	Remove the screw and the power supply.	

Refitting the DSQC 609 power supply

Refitting the power supply

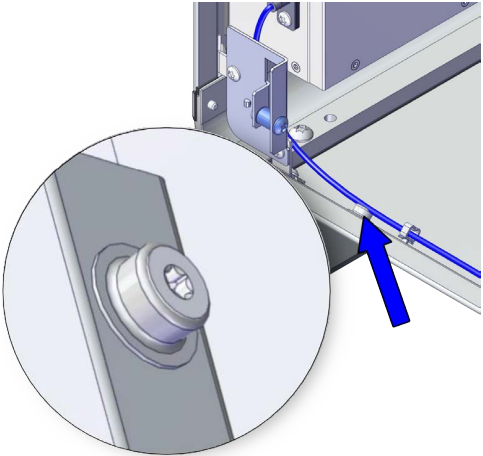
	Action	Note/Illustration
1	 DANGER Before doing any work inside the cabinet, disconnect the mains power. For more information, see Electrical safety on page 31 .	
2	 ELECTROSTATIC DISCHARGE (ESD) The unit is sensitive to ESD. Before handling the unit read the safety information in section The unit is sensitive to ESD on page 44 .	Location of wrist strap button:  <p>xx1900001446</p>

Continues on next page

5.2.11 Replacing the power supply
Continued

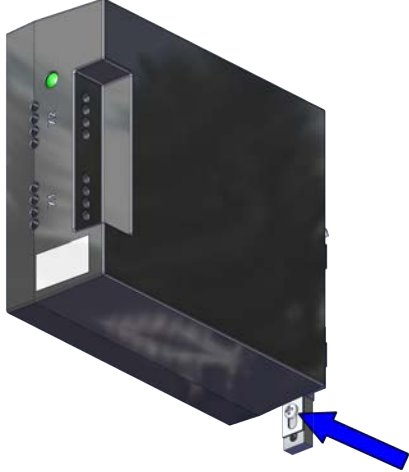
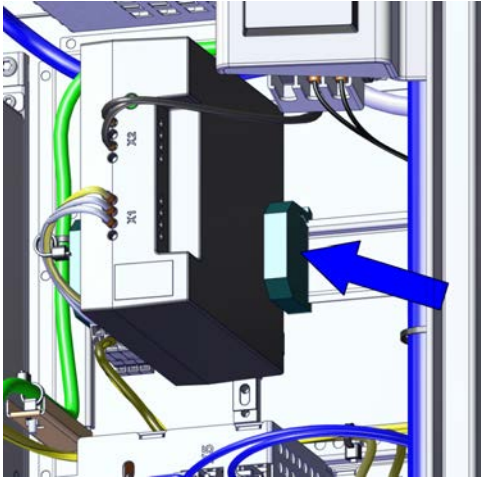
	Action	Note/Illustration
3	Fit the power supply to the bracket and fasten it with screw.	Screws: Cross recessed cheese head screw M4x8 (1 pcs)
4	Reconnect: <ul style="list-style-type: none"> • T5.X1-AC Terminal block • T5.X2-24V Terminal block 	Tightening torque: 1.7 Nm±10%.  xx1900001908
5	Refit the end clamp besides the power supply.	 xx1900001907

Concluding procedure

	Action	Note/Illustration
1	Close the door.	Closing the door on page 188.
2	Perform the function tests to verify that the safety features work properly, see Function tests on page 178.	

5 Repair

5.2.12 Replacing the drive unit

5.2.12 Replacing the drive unit

Location

The illustration shows the location of the drive unit in the controller.

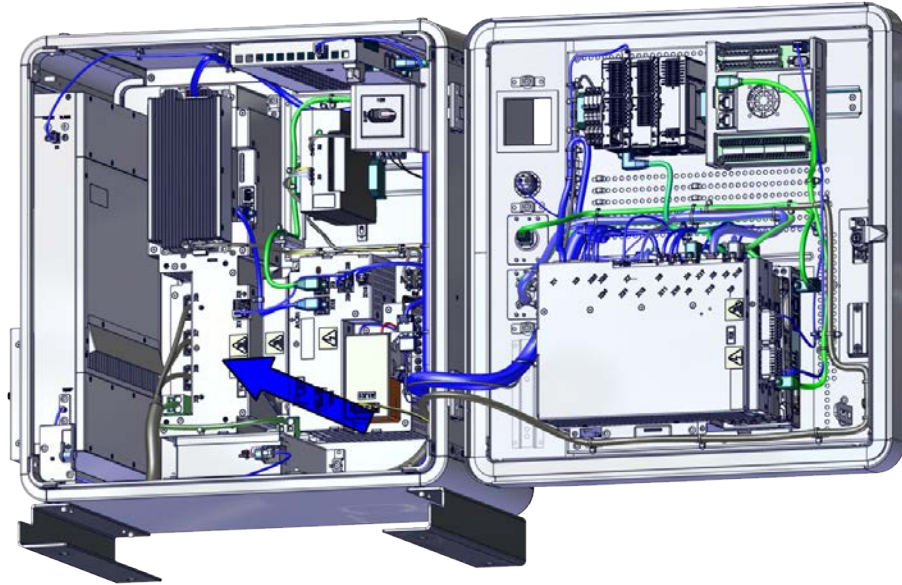

xx1900001471

Required spare parts



Note

The spare part numbers that are listed in the table can be out of date. See the latest spare parts of the OmniCore C90XT via myABB Business Portal, www.abb.com/myABB.

Spare part	Article number	Note
Drive	3HAC063913-001	DSQC3041
Harness DC-BUS	3HAC063344-001	Harness A1.X4 - T4.X5
Harness 24_SYS_DRV	3HAC064389-001	Harness A1.X5 - T4.X1
Harness EtherCAT	3HAC059894-001	Harness T4.X3 - A1.X12

Required tools and equipment

Equipment	Article number	Note
Standard toolkit	-	Content is defined in section Standard toolkit for controller on page 448 .
ESD protective wrist band	-	



Continues on next page

Required documents

Document	Article number	Note
Circuit diagram - OmniCore C90XT	3HAC065464-009	

Removing the drive unit

Preparations

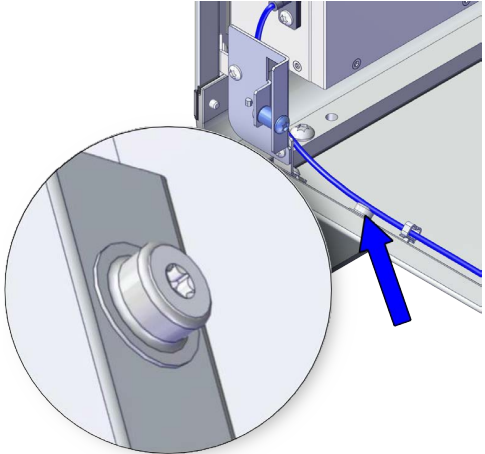
	Action	Note/Illustration
1	 DANGER Before doing any work inside the cabinet, disconnect the mains power. For more information, see Electrical safety on page 31 .	
2	Open the door.	Opening the door on page 188 .
3	 ELECTROSTATIC DISCHARGE (ESD) The unit is sensitive to ESD. Before handling the unit read the safety information in section The unit is sensitive to ESD on page 44 .	Location of wrist strap button:  xx1900001446

Removing the power supply baseline

	Action	Note/Illustration
1	Disconnect: <ul style="list-style-type: none"> • T2.X1 - A1.X6 • T2.X2 - K2.X1 	

Continues on next page

5 Repair

5.2.12 Replacing the drive unit

Continued

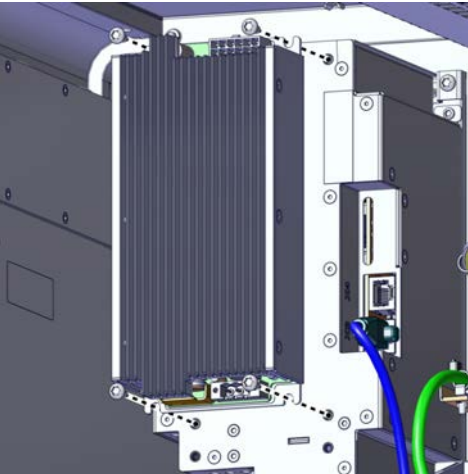
	Action	Note/Illustration
2	Remove the screws and the power supply.	 <p>xx1900001897</p>

Removing the drive unit

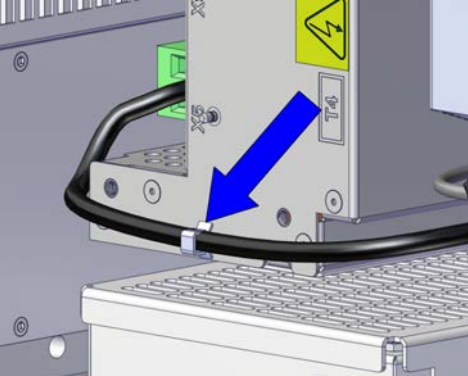
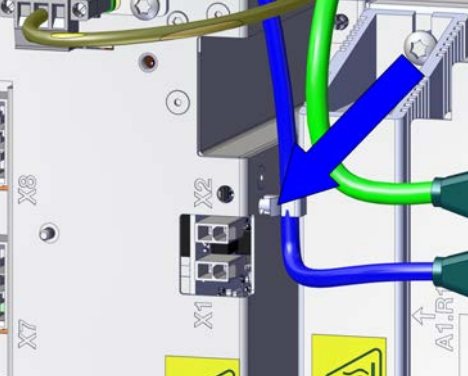
	Action	Note/Illustration
1	Disconnect: <ul style="list-style-type: none"> • X1 - T4.X7, T4.X8, T4.X9 • T4.X5 - A1.X4 • T4.X3 - A1.X12 • T4.X1 - A1.X5 	
2	Cut the cable tie for the DC-bus cable and move it to the other side.	 <p>xx1900001900</p>
3	Cut the cable tie for the EtherCAT cable.	 <p>xx1900002338</p>

Continues on next page

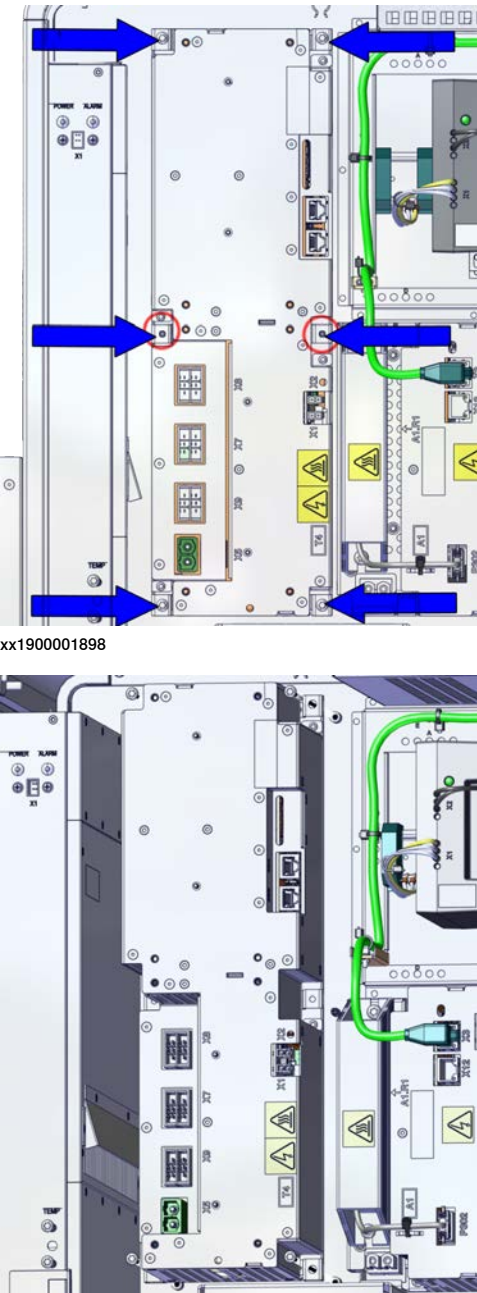
	Action	Note/Illustration
4	Remove the attachment screws and pull the drive unit out from the two snaps.	<p>Lengthened screwdriver</p>  <p>xx1900001898</p> <p>xx1900001899</p>

Continues on next page



5 Repair

5.2.12 Replacing the drive unit

Continued

Refitting the drive unit

Refitting the drive unit

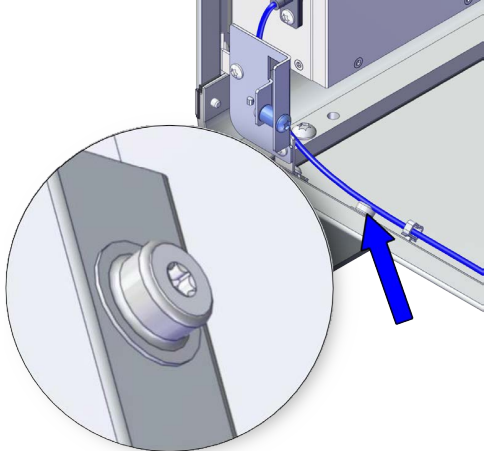
	Action	Note/Illustration
1	 DANGER Before doing any work inside the cabinet, disconnect the mains power. For more information, see Electrical safety on page 31 .	
2	 ELECTROSTATIC DISCHARGE (ESD) The unit is sensitive to ESD. Before handling the unit read the safety information in section The unit is sensitive to ESD on page 44 .	Location of wrist strap button:  xx1900001446

Continues on next page

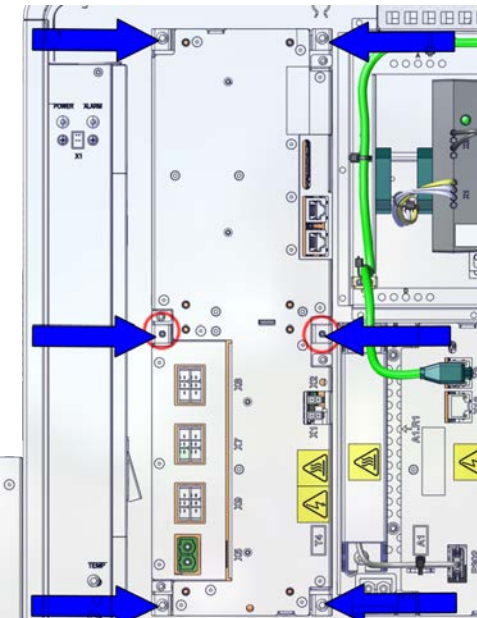
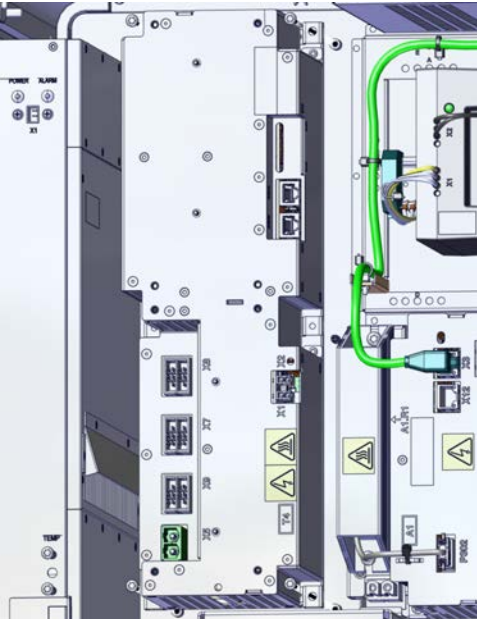
	Action	Note/Illustration
3	Push the drive unit into the snaps on the mounting plate and secure the screws.	<p>Screws: Torx pan head screw M4x8 (4 pcs) Tightening torque: 1.7 Nm±10%.</p>  <p>xx1900001898</p>  <p>xx1900001899</p>

Continues on next page

5 Repair

5.2.12 Replacing the drive unit

Continued

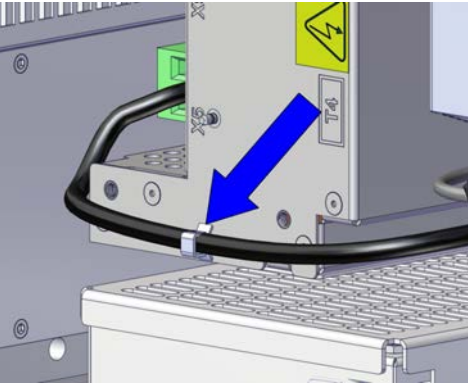
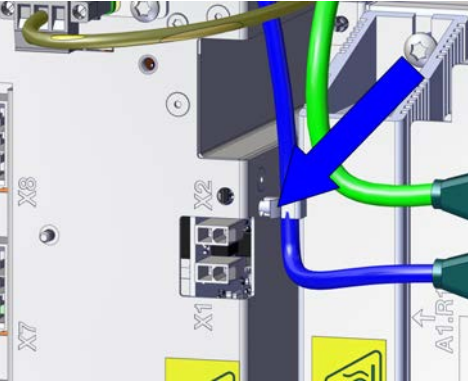
	Action	Note/Illustration
4	Fasten the DC-bus cable with a new cable tie to the drive unit.	 <p>xx1900001900</p>
5	Fasten the EtherCAT cable with a new cable tie to the drive unit.	 <p>xx1900002338</p>
6	Reconnect: <ul style="list-style-type: none"> • T4.X7, T4.X8, T4.X9 • T4.X5 - A1.X4 • T4.X3 - A1.X12 • T4.X1 - A1.X5 	

Refitting the power supply

	Action	Note/Illustration
1	 <p>DANGER</p> <p>Before doing any work inside the cabinet, disconnect the mains power. For more information, see Electrical safety on page 31.</p>	

Continues on next page

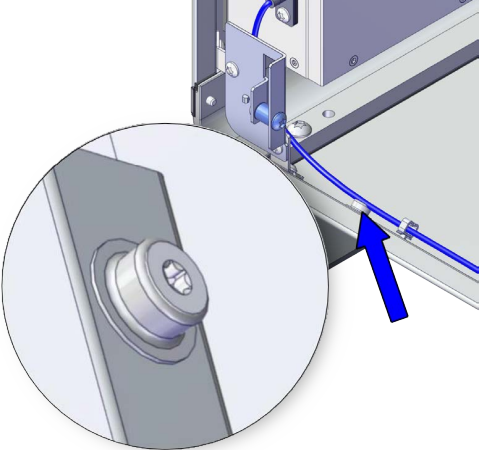
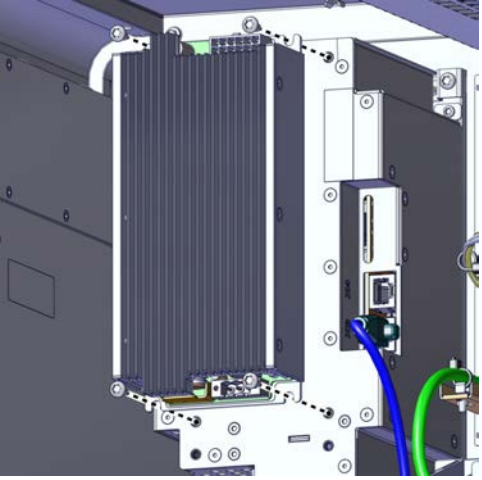
	Action	Note/Illustration
2	<p> ELECTROSTATIC DISCHARGE (ESD)</p> <p>The unit is sensitive to ESD. Before handling the unit read the safety information in section The unit is sensitive to ESD on page 44.</p>	<p>Location of wrist strap button:</p>  <p>xx1900001446</p>
3	<p>Fit the power supply and fasten it with screws.</p>	<p>Screws: Torx pan head screw M4x8 (4 pcs)</p>  <p>xx1900001897</p>
4	<p>Reconnect:</p> <ul style="list-style-type: none"> • T2.X1 - A1.X6 • T2.X2 - K2.X1. 	

Concluding procedure

	Action	Note/Illustration
1	<p>Close the door.</p>	<p>Closing the door on page 188.</p>
2	<p>Perform the function tests to verify that the safety features work properly, see Function tests on page 178.</p>	

5 Repair

5.2.13 Replacing the fieldbus master

5.2.13 Replacing the fieldbus master

Location

The illustration shows the location of the fieldbus master in the controller.

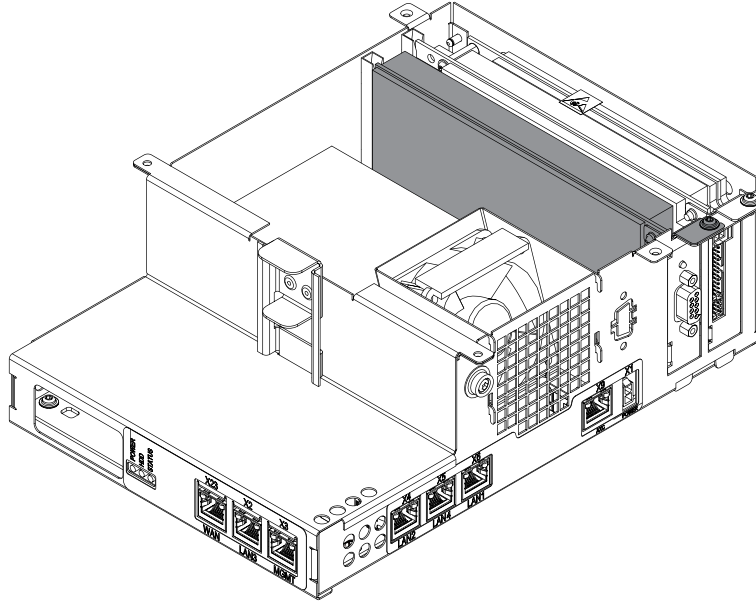

xx1800003420

Required spare parts



Note

The spare part numbers that are listed in the table can be out of date. See the latest spare parts of the OmniCore C90XT via myABB Business Portal, www.abb.com/myABB.

Spare part	Article number	Note
DeviceNet Board	3HAC043383-001	DSQC1006

Required tools and equipment

Equipment	Article number	Note
Standard toolkit	-	Content is defined in section Standard toolkit for controller on page 448 .
ESD protective wrist band	-	

Required documents

Document	Article number	Note
<i>Circuit diagram - OmniCore C90XT</i>	3HAC065464-009	

Continues on next page



Removing the fieldbus master



Note

The fieldbus master is part of an assembly group, secured on a process plate. To remove the fieldbus master, either lift out the assembly group and then remove the fieldbus master, or take out the parts on top of the main computer and then remove the fieldbus master.

Preparations

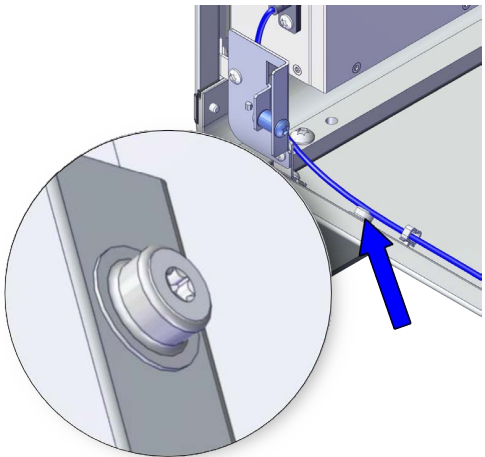
	Action	Note/Illustration
1	 DANGER Before doing any work inside the cabinet, disconnect the mains power. For more information, see Electrical safety on page 31 .	
2	Open the door.	Opening the door on page 188 .
3	 ELECTROSTATIC DISCHARGE (ESD) The unit is sensitive to ESD. Before handling the unit read the safety information in section The unit is sensitive to ESD on page 44 .	Location of wrist strap button:  xx1900001446

Removing the main computer assembly



	Action	Note/Illustration
1	Disconnect all the connectors on the assembly group of the robot signal exchange proxy, Ethernet switch (option), connected services gateway, and main computer.	

Continues on next page



5 Repair

5.2.13 Replacing the fieldbus master

Continued

Action	Note/Illustration
<p>For the robot signal exchange proxy:</p> <ul style="list-style-type: none"> • K2.X8 - A2.X6 • (option): K2.X2 - K4.X8, A2.X1 • K2.X12 - A2.K3.X6, A2.K3.X7 • K2.X10 - A1.X13 • K2.X21 - TempSensor • K2.X4 - A1.X9 • K2.X3 - K6.X1, A2.K3.X1, K5.1.X4, K7.X1 • K2.X1 - T2.X2 • K2.X17 - G2.X1, G1.X2 • K2.X6, K2.X11 - A1.X2 • K2.X7, K2.X22 - Harn. LV robot power • K2.X9 & X13 - FlexPendant 	
<p>For the Ethernet extension switch (option):</p> <ul style="list-style-type: none"> • K2.X2 - K4.X8, A2.X1 • K4.X7 - K5.1.X5 • K4.X6 - A2.X4 	
<p>For the connected services gateway:</p> <ul style="list-style-type: none"> • K7.X1 - K2.X3ⁱ • K7.X2 - A2.X5 <p> Note</p> <p>The connector K7.X2 is locked; grab the connector, push it in to release it and then remove the connector.</p>	
<p>For the main computer:</p> <ul style="list-style-type: none"> • K2.X8 - A2.X6 • K2.X2 - K4.X8, A2.X1 • K2.X12 - A2.K3.X6, A2.K3.X7 • K6.X2 - A2.X9 • A2.X5 - K7.X2 • A2.X4 - K4.X6/K5.1.X5 <p> Note</p> <p>If the Ethernet extension switch is installed, connect and disconnect the connector A2.X4 to/from K4.X6.</p> <p>If the Ethernet extension switch is not installed, connect and disconnect the connector A2.X4 to/from K5.1.X5.</p>	

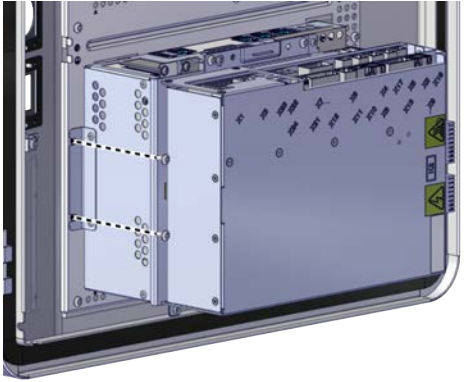
Continues on next page

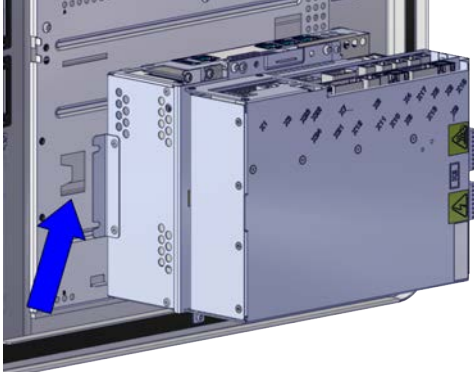
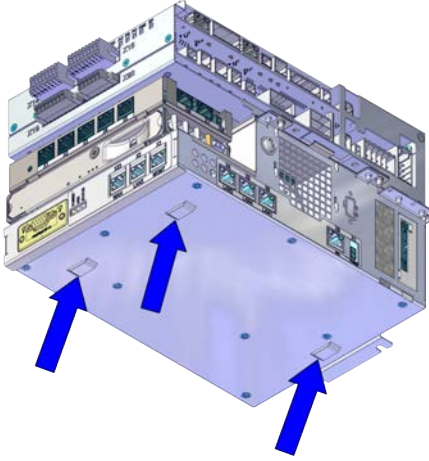
	Action	Note/Illustration
2	Remove the screws holding the main computer.	 <p>xx1900001877</p>
3	Remove the assembly from the mounting plate.  Note Avoid colliding with the frame when removing the unit.  ELECTROSTATIC DISCHARGE (ESD) When handling the computer outside of the controller, use the wrist strap button located on the side of the computer.	 <p>xx1900001878</p>  <p>xx1900001885</p>

ⁱ For connected services gateway wired, there is no power cable.

5 Repair

5.2.13 Replacing the fieldbus master

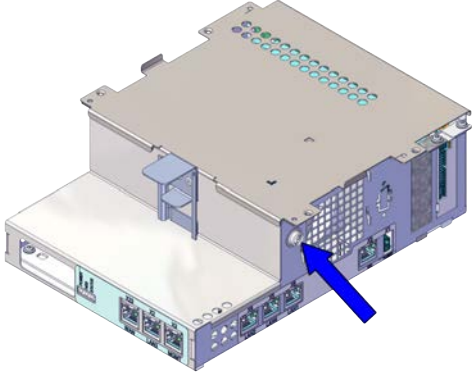
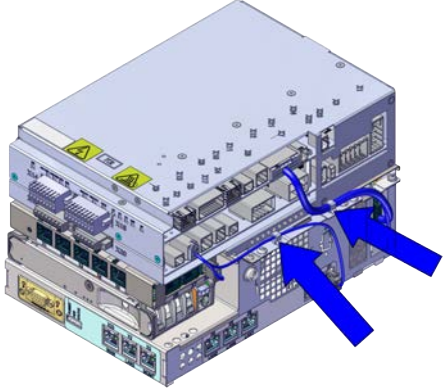
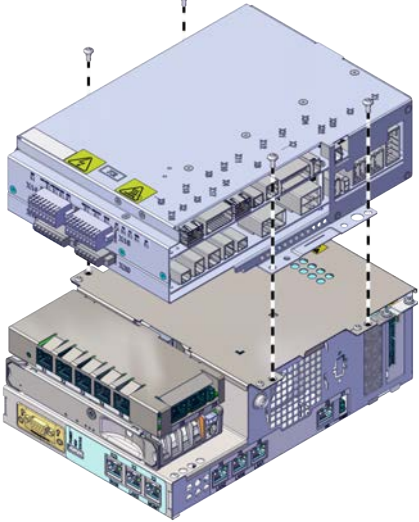

Continued

Removing the robot signal exchange proxy

	Action	Note/Illustration
1	 <p>ELECTROSTATIC DISCHARGE (ESD)</p> <p>When handling the computer outside of the controller, use the wrist strap button located on the side of the computer.</p>	<p>Location of wrist strap button:</p>  <p>xx2000000419</p>
2	<p>Pull the cable ties out from the locking holes.</p>	 <p>xx1900001879</p>
3	<p>Remove the screws and lift out the robot signal exchange proxy.</p>	 <p>xx1900001880</p>

Continues on next page

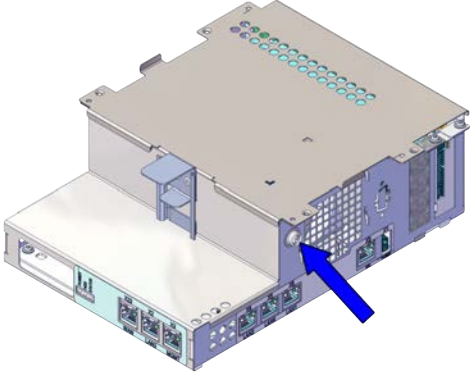
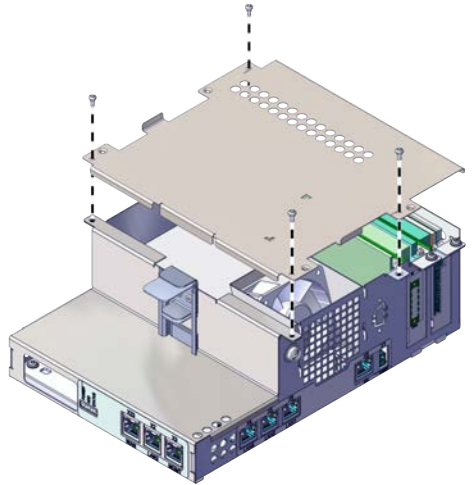
Removing the fieldbus master



	Action	Note/Illustration
1	<p> ELECTROSTATIC DISCHARGE (ESD)</p> <p>When handling the computer outside of the controller, use the wrist strap button located on the side of the computer.</p>	<p>Location of wrist strap button:</p>  <p>xx2000000419</p>
2	<p>Remove the attachment screws and take the cover off.</p>	 <p>xx1900001909</p> <p> Note</p> <p>The Connected Services Gateway and Ethernet extension switch are omitted on the illustration to make it more clear.</p>

Continues on next page

5 Repair

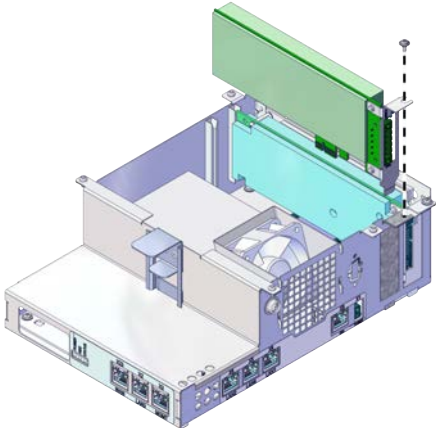

5.2.13 Replacing the fieldbus master

Continued

	Action	Note/Illustration
3	<p>Remove the attachment screw on the fieldbus master and take out the fieldbus master.</p> <p> Note</p> <p>Be careful when you pull it out from the card slot.</p>	 <p>xx1900001910</p> <p> Note</p> <p>The Connected Services Gateway and Ethernet extension switch are omitted on the illustration to make it more clear.</p>

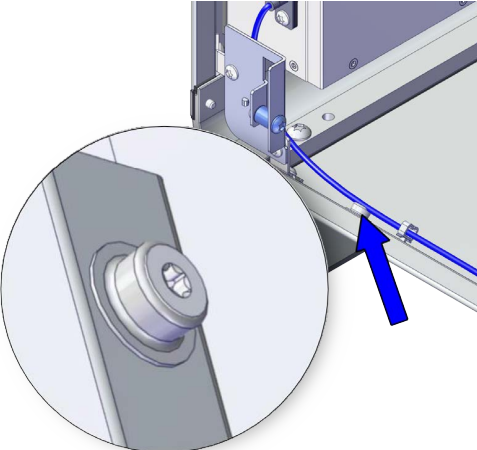

Refitting the fieldbus master

Preparations

	Action	Note/Illustration
1	<p> DANGER</p> <p>Before doing any work inside the cabinet, disconnect the mains power. For more information, see Electrical safety on page 31.</p>	
2	<p> ELECTROSTATIC DISCHARGE (ESD)</p> <p>The unit is sensitive to ESD. Before handling the unit read the safety information in section The unit is sensitive to ESD on page 44.</p>	 <p>xx1900001446</p>

Continues on next page

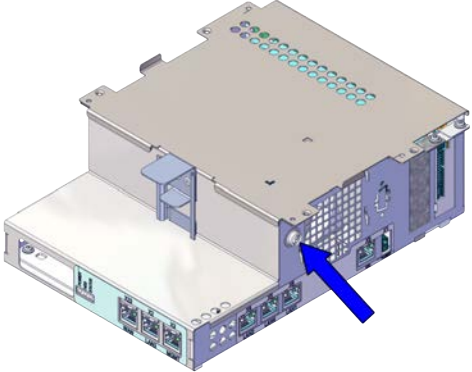
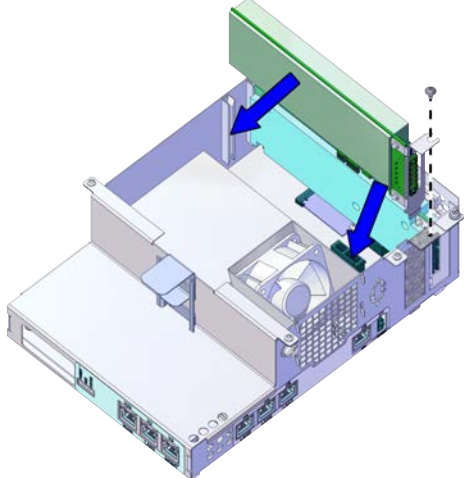
Refitting the fieldbus master





	Action	Note/Illustration
1	<p> ELECTROSTATIC DISCHARGE (ESD)</p> <p>When handling the computer outside of the controller, use the wrist strap button located on the side of the computer.</p>	<p>Location of wrist strap button:</p>  <p>xx2000000419</p>
2	<p>Insert the fieldbus master straight into the card slots along the guide rail.</p>	 <p>xx1900001911</p> <p> Note</p> <p>The Connected Services Gateway and Ethernet extension switch are omitted on the illustration to make it more clear.</p>

Continues on next page

5 Repair

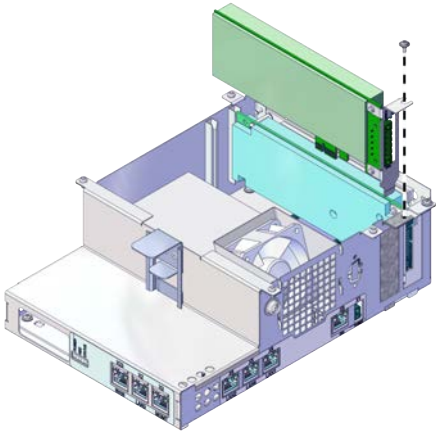

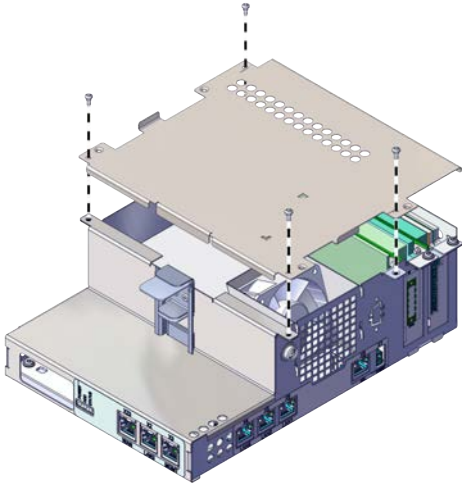
5.2.13 Replacing the fieldbus master

Continued

	Action	Note/Illustration
3	Secure the fieldbus adapter with the screw.	<p>Screws: Screw with flange M3x6 (1 pcs) Tightening torque: 1.7 Nm±10%.</p>  <p>xx1900001910</p> <p> Note</p> <p>The Connected Services Gateway and Ethernet extension switch are omitted on the illustration to make it more clear.</p>
4	Refit the cover of the main computer and secure the screws.	<p>Screws: Hexalobular socket pan head screw M3x6 (4 pcs) Tightening torque: 1.7 Nm±10%.</p>  <p>xx1900001909</p> <p> Note</p> <p>The Connected Services Gateway and Ethernet extension switch are omitted on the illustration to make it more clear.</p>

Continues on next page

Refitting the robot signal exchange proxy

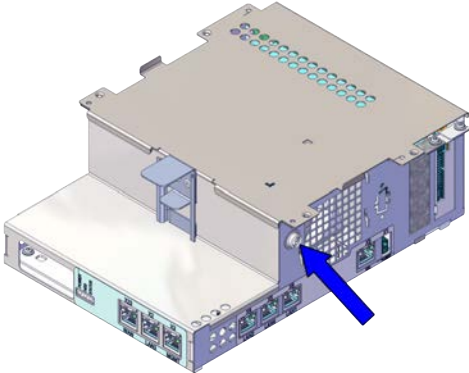
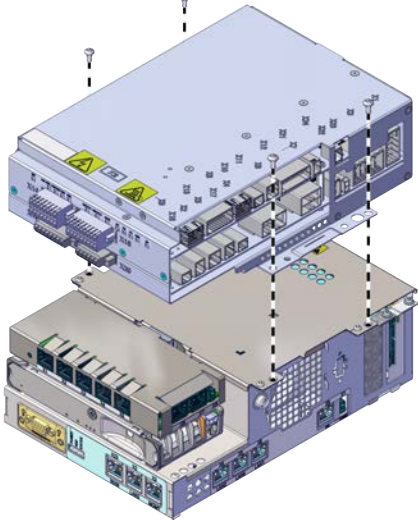
	Action	Note/Illustration
1	<p> DANGER</p> <p>Before doing any work inside the cabinet, disconnect the mains power. For more information, see Electrical safety on page 31.</p>	
2	<p> ELECTROSTATIC DISCHARGE (ESD)</p> <p>The unit is sensitive to ESD. Before handling the unit read the safety information in section The unit is sensitive to ESD on page 44.</p>	<p>Location of wrist strap button:</p>  <p>xx2000000419</p>
3	<p>Fit the robot signal exchange proxy and secure the screws.</p>	<p>Screws: Torx pan head screw M4x8 (4 pcs) Tightening torque: 1.7 Nm±10%.</p>  <p>xx1900001880</p>

Continues on next page



5 Repair

5.2.13 Replacing the fieldbus master

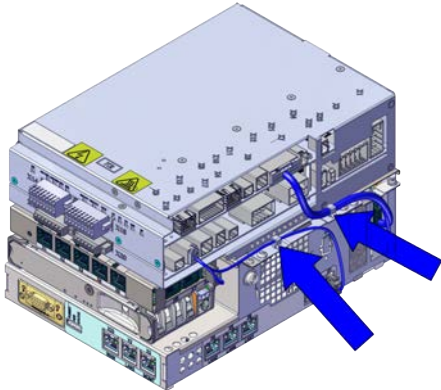
Continued

	Action	Note/Illustration
4	Insert the cable ties into the locking holes.	 <p>xx1900001879</p>

Refitting the main computer assembly to the cabinet

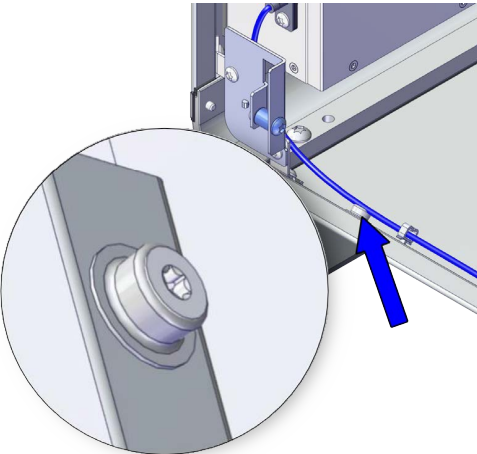
	Action	Note/Illustration
1	 <p>DANGER</p> <p>Before doing any work inside the cabinet, disconnect the mains power. For more information, see Electrical safety on page 31.</p>	
2	 <p>ELECTROSTATIC DISCHARGE (ESD)</p> <p>When handling the computer outside of the controller, use the wrist strap button located on the side of the computer.</p>	<p>Location of wrist strap button:</p>  <p>xx1900001446</p>

Continues on next page

Action	Note/Illustration
3	<p>Refit the assembly onto the mounting plate.</p>
4	<p>Fasten the assembly with the screws.</p>
5	<p>Reconnect all the connectors on assembly of the robot signal exchange proxy, ethernet extension-seven port switch (option), ABB ability™ connected services, and main computer.</p>

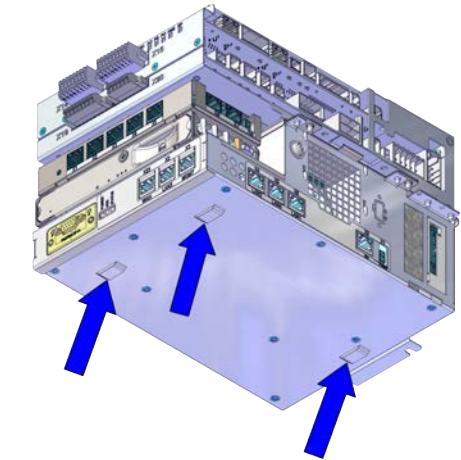

xx1900001885

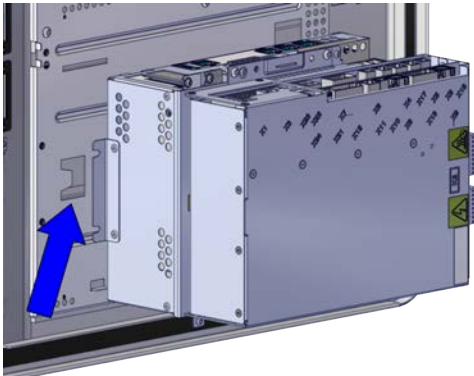

xx1900001878





xx1900001877

Continues on next page

5 Repair

5.2.13 Replacing the fieldbus master

Continued

Action	Note/Illustration
<p>For the robot signal exchange proxy:</p> <ul style="list-style-type: none"> • K2.X8 - A2.X6 • (option): K2.X2 - K4.X8, A2.X1 • K2.X12 - A2.K3.X6, A2.K3.X7 • K2.X10 - A1.X13 • K2.X21 - TempSensor (G3.TEMP) • K2.X4 - A1.X9 • K2.X3 - K6.X1, A2.K3.X1, K5.1.X4, K7.X1 • K2.X1 - T2.X2 • K2.X17 - G3.X1, G1.X2 • K2.X6, K2.X11 - A1.X2 • K2.X7, K2.X22 - Harn. LV robot power (X1) • K2.X9 & X13 - FlexPendant (X4) 	
<p>For the Ethernet extension switch (option):</p> <ul style="list-style-type: none"> • K2.X2 - K4.X8, A2.X1 • K4.X7 - K5.1.X5 • K4.X6 - A2.X4 	
<p>For the connected services gateway:</p> <ul style="list-style-type: none"> • K7.X1 - K2.X3ⁱ • K7.X2 - A2.X5 <p> Note</p> <p>The connector K7.X2 is locked; grab the connector, push it in to release it and then remove the connector.</p>	
<p>For the main computer:</p> <ul style="list-style-type: none"> • A2.X3 - X24 • K2.X8 - A2.X6 • K2.X2 - K4.X8, A2.X1 • K2.X12 - A2.K3.X6, A2.K3.X7 • K6.X2 - A2.X9 • A2.X5 - K7.X2 • A2.X4 - K4.X6/K5.1.X5 <p> Note</p> <p>If the Ethernet extension switch is installed, connect and disconnect the connector A2.X4 to/from K4.X6.</p> <p>If the Ethernet extension switch is not installed, connect and disconnect the connector A2.X4 to/from K5.1.X5.</p>	

ⁱ For connected services gateway wired, there is no power cable.

Continues on next page

Concluding procedure

	Action	Note/Illustration
1	Close the door.	Closing the door on page 188.
2	Perform the function tests to verify that the safety features work properly, see Function tests on page 178.	

5 Repair

5.2.14 Replacing the conveyor tracking module (CTM)

5.2.14 Replacing the conveyor tracking module (CTM)

Location

The illustration shows the location of the conveyor tracking module in the controller.

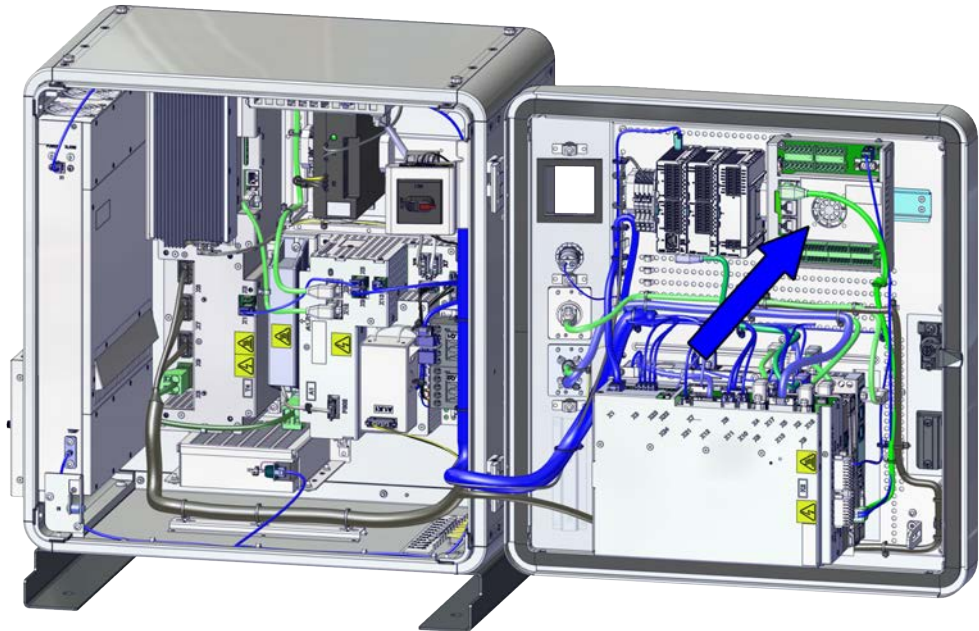

xx1900001472

Required spare parts



Note

The spare part numbers that are listed in the table can be out of date. See the latest spare parts of the OmniCore C90XT via myABB Business Portal, www.abb.com/myABB.

Spare part	Article number	Note
Conveyor tracking module [3103-1]	3HNA027579-001	DSQC2000
CONNECTOR KIT - DSQC2000	3HNA029345-001	
Harness 24V_CTM	3HAC069618-001	Power cable of CTM

Required tools and equipment

Equipment	Article number	Note
Standard toolkit	-	Content is defined in section Standard toolkit for controller on page 448 .
ESD protective wrist band	-	



Continues on next page

Required documents

Document	Article number	Note
Circuit diagram - OmniCore C90XT	3HAC065464-009	
Application manual - Conveyor tracking	3HAC066561-001	

Removing the conveyor tracking module (option)

Preparations

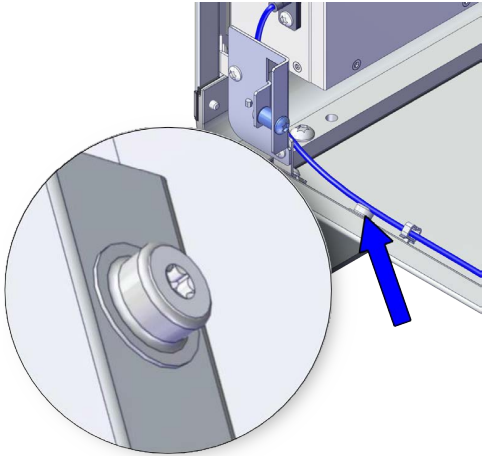
Action	Note/Illustration
<p>1</p>  <p>DANGER</p> <p>Before doing any work inside the cabinet, disconnect the mains power. For more information, see Electrical safety on page 31.</p>	
<p>2</p> <p>Open the door.</p>	<p>Opening the door on page 188.</p>
<p>3</p>  <p>ELECTROSTATIC DISCHARGE (ESD)</p> <p>The unit is sensitive to ESD. Before handling the unit read the safety information in section The unit is sensitive to ESD on page 44.</p>	<p>Location of wrist strap button:</p>  <p>xx1900001446</p>

Removing the conveyor tracking module (option)



Action	Note/Illustration
<p>1</p> <p>Disconnect:</p> <ul style="list-style-type: none"> • B1.X1 - K2.X19.1 & K2.X19.2 • B1.X7 - K4.X1-X5 	

Continues on next page

5 Repair

5.2.14 Replacing the conveyor tracking module (CTM)

Continued

	Action	Note/Illustration
2	<p>Pull on the lower side of the conveyor tracking module slightly and take out the conveyor tracking module.</p> <p> Note</p> <p>The conveyor tracking module is secured by the buckles.</p> <p>Be careful with the direction of the buckles when doing assembling/disassembling work.</p>	 <p>xx1900001912</p>  <p>xx1900001913</p>

Refitting the conveyor tracking module (option)

Refitting the conveyor tracking module (option)

	Action	Note/Illustration
1	<p> DANGER</p> <p>Before doing any work inside the cabinet, disconnect the mains power. For more information, see Electrical safety on page 31.</p>	

Continues on next page

5.2.14 Replacing the conveyor tracking module (CTM)

Continued

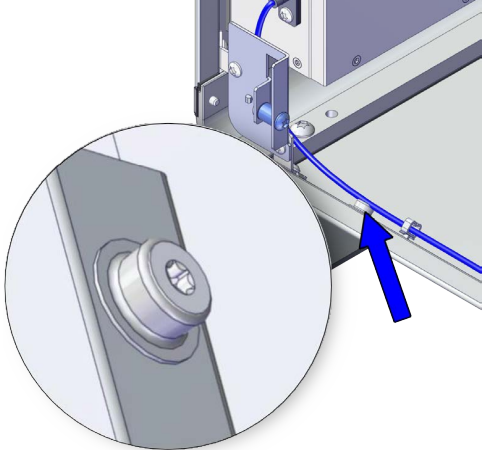
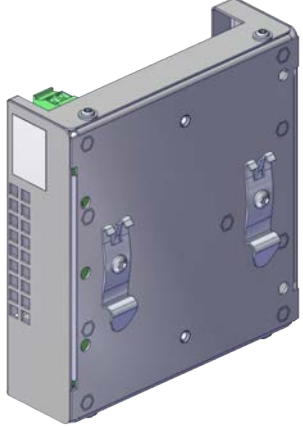
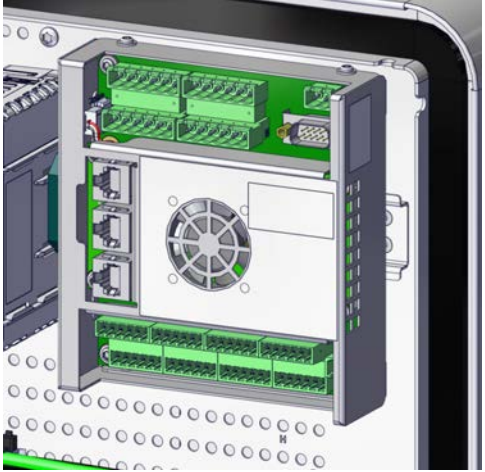
	Action	Note/Illustration
2	<p> ELECTROSTATIC DISCHARGE (ESD)</p> <p>The unit is sensitive to ESD. Before handling the unit read the safety information in section <i>The unit is sensitive to ESD on page 44.</i></p>	<p>Location of wrist strap button:</p>  <p>xx1900001446</p>
3	<p>Hang the conveyor tracking module into the bracket and push the lower of it until you hear a clear clicking sound.</p>	 <p>xx1900001913</p>  <p>xx1900001912</p>

Continues on next page

5 Repair

5.2.14 Replacing the conveyor tracking module (CTM)

Continued

	Action	Note/Illustration
4	Connect the adapter cable to the conveyor tracking module. <ul style="list-style-type: none">• B1.X1 - K2.X19.1 & K2.X19.2• B1.X7 - K4.X1-X5	
5	Stick the other connector onto the side of the digital base with the self-adhesive part.	

Concluding procedure

	Action	Note/Illustration
1	Close the door.	Closing the door on page 188.
2	Perform the function tests to verify that the safety features work properly, see Function tests on page 178.	

5.2.15 Replacing the air filter

Location

The illustration shows the location of the air filter on the controller.

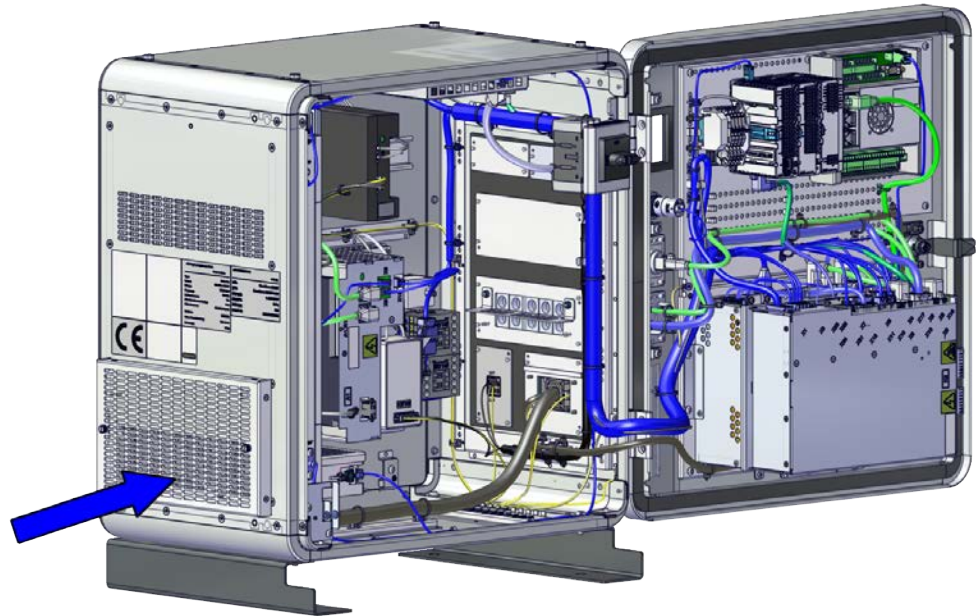

xx1900001473

Required spare parts



Note

The spare part numbers that are listed in the table can be out of date. See the latest spare parts of the OmniCore C90XT via myABB Business Portal, www.abb.com/myABB.

Spare part	Article number	Note
Air filter-coarse filter	3HAC068415-001	
Air filter-Fine filter	3HAC068416-001	
Air filter (Polymeric)	3HAC068543-001	Filter element of fine filter

Required tools and equipment

Equipment	Article number	Note
Standard toolkit	-	Content is defined in section Standard toolkit for controller on page 448 .
ESD protective wrist band	-	

Continues on next page

5 Repair

5.2.15 Replacing the air filter

Continued

Required documents



Document	Article number	Note
Circuit diagram - OmniCore C90XT	3HAC065464-009	

Removing the air filter

Preparations

Action	Note/Illustration
1  DANGER Before doing any work inside the cabinet, disconnect the mains power. For more information, see Electrical safety on page 31 .	

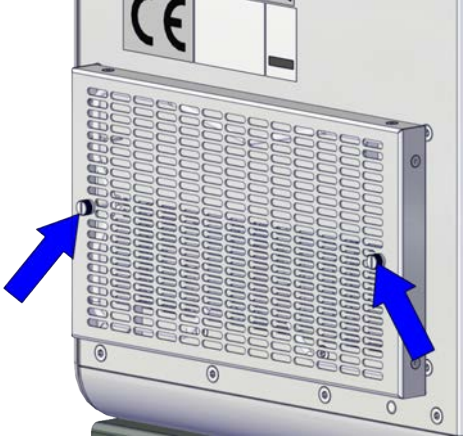
Removing the air filter

Action	Note/Illustration
1 Loosen the attachment screws on the air filter.	 xx1900001491
2 Remove the air filter unit.	 xx1900001492

Continues on next page

Removing the polymeric filter element

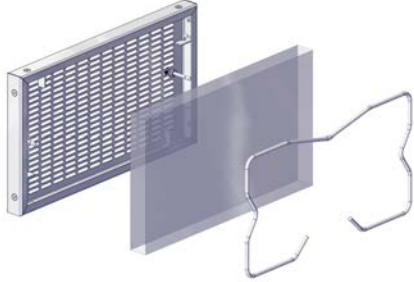
	Action	Note/Illustration
1	Take out the polymeric filter element from the filter.	 <p data-bbox="954 707 1059 725">xx2000000421</p>

Refitting the air filter

Refitting the polymeric filter element

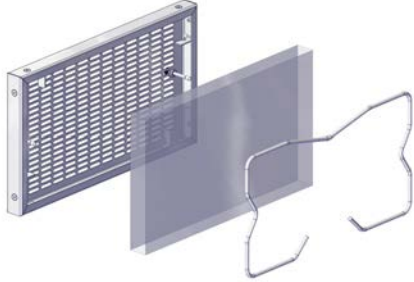
	Action	Note/Illustration
1	Insert the polymeric filter element to the filter and secure with the metallic line.	 <p data-bbox="954 1285 1059 1303">xx2000000421</p>

Refitting the air filter

	Action	Note/Illustration
1	 <p data-bbox="592 1487 699 1514">DANGER</p> <p data-bbox="501 1547 943 1655">Before doing any work inside the cabinet, disconnect the mains power. For more information, see Electrical safety on page 31.</p>	
2	Refit the air filter unit to the cabinet.	

Continues on next page

5 Repair

5.2.15 Replacing the air filter

Continued

	Action	Note/Illustration
3	Secure it with the screws.	 <p>xx1900001492</p>

Concluding procedure

	Action	Note/Illustration
1	Perform the function tests to verify that the safety features work properly, see Function tests on page 178 .	

5.3 Replacing parts on the panels

5.3.1 Replacing the manipulator signal connector (SMB)

Location

The illustration shows the location of the manipulator signal connector.



xx1900001476

Required spare parts



Note

The spare part numbers that are listed in the table can be out of date. See the latest spare parts of the OmniCore C90XT via myABB Business Portal, www.abb.com/myABB.

Spare part	Article number	Note
Harness Single SMB connection	3HAC069674-001	Harness single SMB
Harness Double SMB connection	3HAC069675-001	Harness double SMB

Continues on next page

5 Repair

5.3.1 Replacing the manipulator signal connector (SMB)

Continued

Required tools and equipment



Equipment	Article number	Note
Standard toolkit	-	Content is defined in section Standard toolkit for controller on page 448 .
ESD protective wrist band	-	

Required documents

Document	Article number	Note
<i>Circuit diagram - OmniCore C90XT</i>	3HAC065464-009	

Removing the manipulator signal connector

Preparations

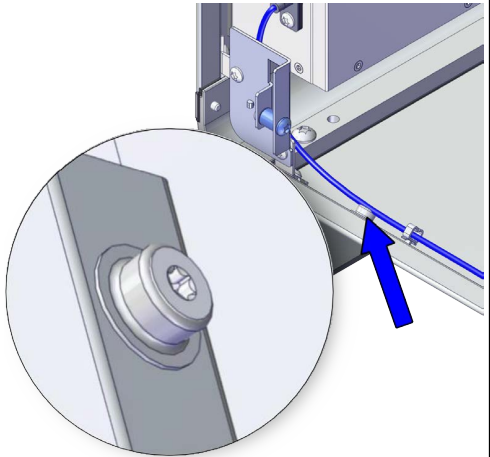
	Action	Note/Illustration
1	 DANGER Before doing any work inside the cabinet, disconnect the mains power. For more information, see Electrical safety on page 31 .	
2	Open the door.	Opening the door on page 188 .
3	 ELECTROSTATIC DISCHARGE (ESD) The unit is sensitive to ESD. Before handling the unit read the safety information in section The unit is sensitive to ESD on page 44 .	Location of wrist strap button:  xx1900001446

Continues on next page

5.3.1 Replacing the manipulator signal connector (SMB)

Continued

Removing the manipulator signal connector

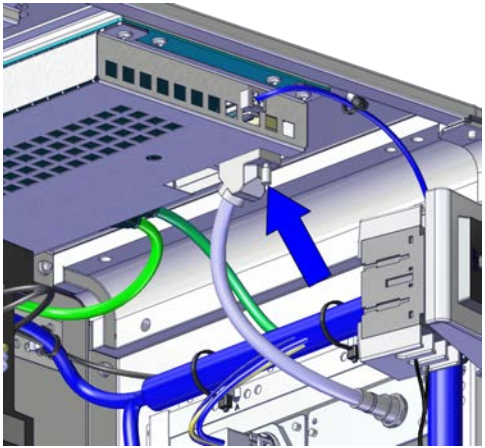
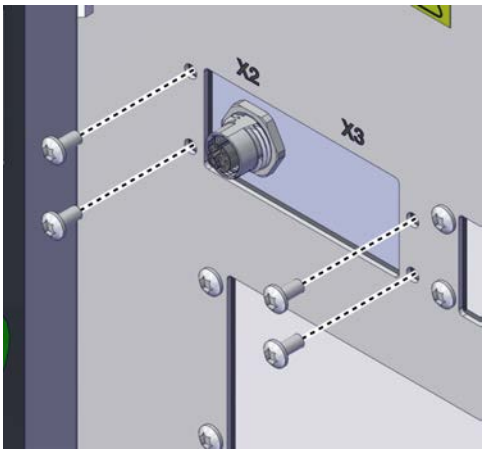
	Action	Note/Illustration
1	Loosen the screw and disconnect: <ul style="list-style-type: none"> • K6.X4, K6.X5 - SMB. 	 <p>xx1900001914</p>
2	Remove the attachment screws on the cover.	 <p>xx1900001915</p>
3	Push the manipulator signal connector into the cabinet.	
4	Take the manipulator signal connector out.	

Refitting the manipulator signal connector

Refitting the manipulator signal connector

	Action	Note/Illustration
1	 <p>DANGER</p> <p>Before doing any work inside the cabinet, disconnect the mains power. For more information, see Electrical safety on page 31.</p>	

Continues on next page

5 Repair

5.3.1 Replacing the manipulator signal connector (SMB)

Continued

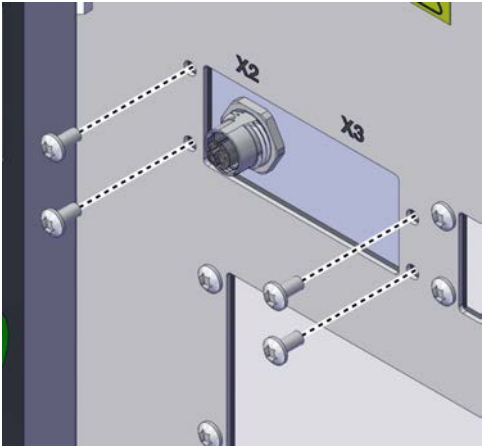
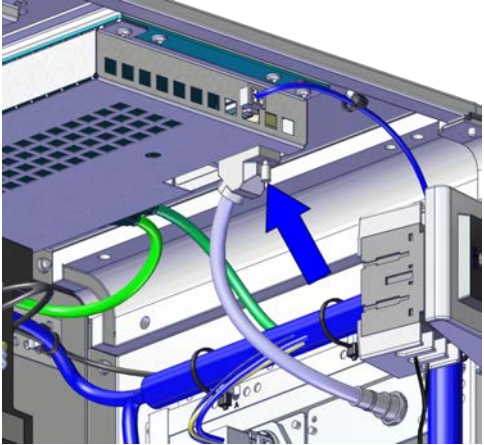
	Action	Note/Illustration
2	 ELECTROSTATIC DISCHARGE (ESD) The unit is sensitive to ESD. Before handling the unit read the safety information in section <i>The unit is sensitive to ESD on page 44.</i>	
3	Insert the manipulator signal connector into the cover from inner side of the cabinet.	
4	Secure it with the attachment screws.	Screws: Torx pan head screw M4x8 (4 pcs) Tightening torque: 2.7 Nm±10%.  xx1900001915
5	Reconnect and secure: <ul style="list-style-type: none"> • K6.X4, K6.X5 - SMB. 	 xx1900001914

Concluding procedure

	Action	Note/Illustration
1	Close the door.	<i>Closing the door on page 188.</i>
2	Perform the function tests to verify that the safety features work properly, see <i>Function tests on page 178.</i>	

5.3.2 Replacing the motor connector

Location

The illustration shows the location of the motor connector in the controller.



xx1900001478

Required spare parts



Note

The spare part numbers that are listed in the table can be out of date. See the latest spare parts of the OmniCore C90XT via myABB Business Portal, www.abb.com/myABB.

Spare part	Article number	Note
Harness Motors power LV 6-axis	3HAC069672-001	

Required tools and equipment

Equipment	Article number	Note
Standard toolkit	-	Content is defined in section Standard toolkit for controller on page 448 .
ESD protective wrist band	-	

Continues on next page

5 Repair

5.3.2 Replacing the motor connector

Continued

Required documents



Document	Article number	Note
<i>Circuit diagram - OmniCore C90XT</i>	3HAC065464-009	

Continues on next page

5.3.2.1 Replacing the motor connector

Removing the motor connector

Preparations

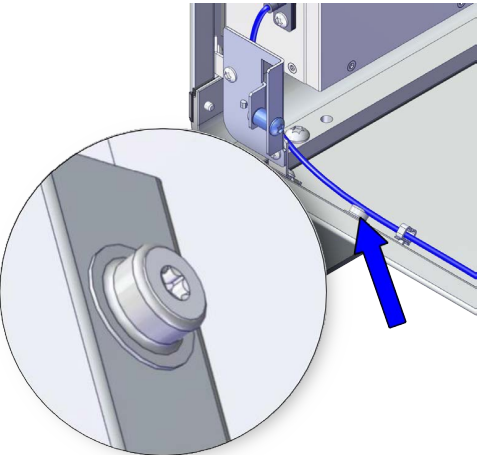
	Action	Note/Illustration
1	 DANGER Before doing any work inside the cabinet, disconnect the mains power. For more information, see Electrical safety on page 31 .	
2	Open the door.	Opening the door on page 188 .
3	 ELECTROSTATIC DISCHARGE (ESD) The unit is sensitive to ESD. Before handling the unit read the safety information in section The unit is sensitive to ESD on page 44 .	Location of wrist strap button:  xx1900001446

Removing the motor connector



	Action	Note/Illustration
1	Disconnect the following connectors for the motor connector: <ul style="list-style-type: none"> • T4.X7, T4.X8, T4.X9 • X1 - K2.X7 & X22 • PE.5 & PE.6 	

Continues on next page

5 Repair

5.3.2.1 Replacing the motor connector

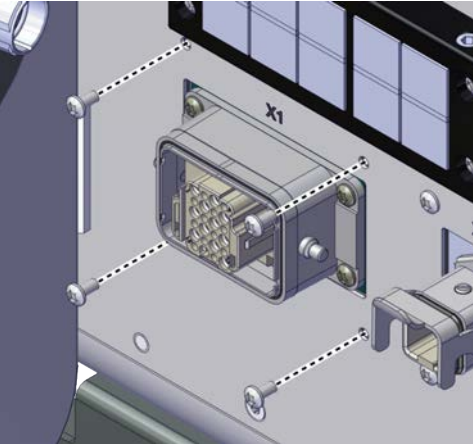
Continued

	Action	Note/Illustration
2	Remove the attachment screws on the cover.	 <p>xx1900001916</p>
3	Push the motor connector into the cabinet.	
4	Take the motor connector cable out from the velcro in the cabinet.  Note Make records about the sequence that cables are removed. The cables need to be installed in the same position.	
5	Take out the motor connector.	



Refitting the motor connector

Refitting the motor connector

	Action	Note/Illustration
1	 DANGER Before doing any work inside the cabinet, disconnect the mains power. For more information, see Electrical safety on page 31 .	

Continues on next page

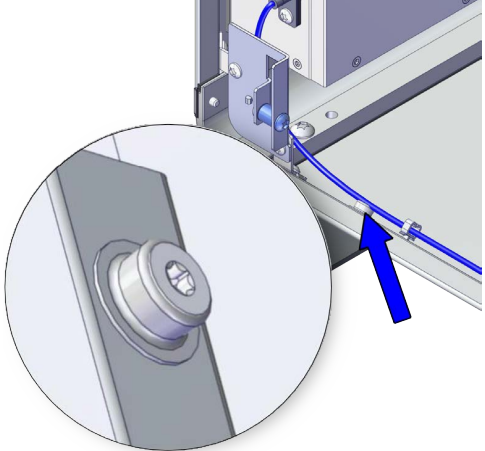
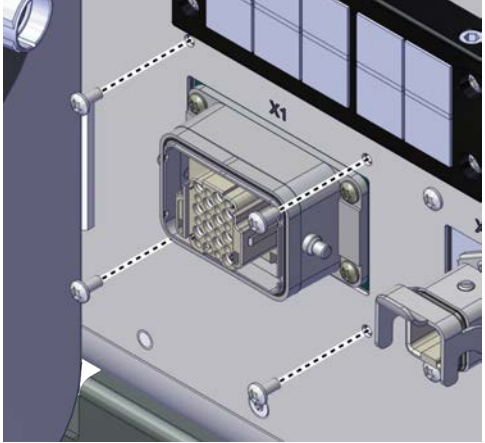
5.3.2.1 Replacing the motor connector
Continued

	Action	Note/Illustration
2	 <p>ELECTROSTATIC DISCHARGE (ESD)</p> <p>The unit is sensitive to ESD. Before handling the unit read the safety information in section <i>The unit is sensitive to ESD on page 44.</i></p>	<p>Location of wrist strap button:</p>  <p>xx1900001446</p>
3	<p>Insert the motor connector into the cover from inner side of the cabinet and fasten it with the screws.</p>	<p>Screws: Torx pan head screw M4x8 (4 pcs) Tightening torque: 2.7 Nm±10%.</p>  <p>xx1900001916</p>
4	<p>Reconnect:</p> <ul style="list-style-type: none"> • T4.X7, T4.X8, T4.X9 • X1 - K2.X7 & X22 • PE.5 & PE.6 	
5	<p>Secure the motor connector cables with the velcro on the frame of the cabinet.</p>  <p>Tip</p> <p>Use the same position as from removing the motor connector.</p>	

Concluding procedure

	Action	Note/Illustration
1	Close the door.	<i>Closing the door on page 188.</i>

Continues on next page

5 Repair

5.3.2.1 Replacing the motor connector

Continued

	Action	Note/Illustration
2	Perform the function tests to verify that the safety features work properly, see Function tests on page 178 .	

5.3.3 Replacing the fieldbus adapter slave

Location

The illustration shows the location of the fieldbus adapter slave in the controller.

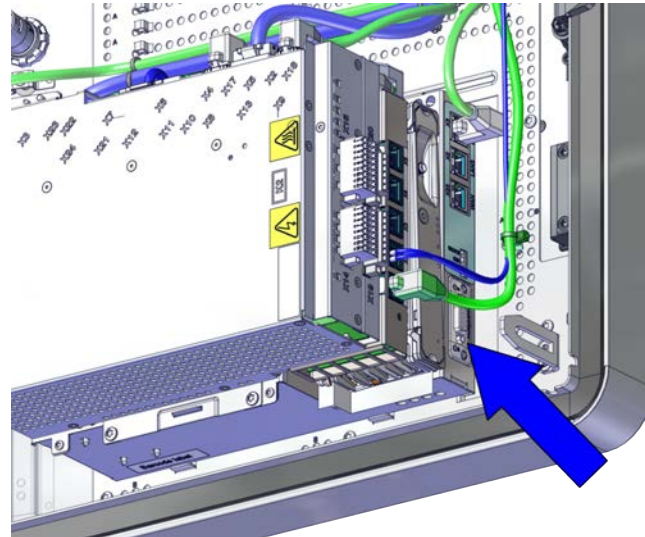

xx1900001474

Required spare parts



Note

The spare part numbers that are listed in the table can be out of date. See the latest spare parts of the OmniCore C90XT via myABB Business Portal, www.abb.com/myABB.

Spare part	Article number	Note
Fieldbus slot cover	3HAC062390-001	
DeviceNet Slave Fieldbus adaptor [3030-1]	3HAC045973-001	DSQC1004
ProfiNet Board [3022-1]	3HAC031670-001	DSQC 688
Ethernet Unit [3025-1]	3HAC027652-001	DSQC 669

Required tools and equipment

Equipment	Article number	Note
Standard toolkit	-	Content is defined in section Standard toolkit for controller on page 448 .
ESD protective wrist band	-	

Required documents

Document	Article number	Note
Circuit diagram - OmniCore C90XT	3HAC065464-009	



Continues on next page

5 Repair

5.3.3 Replacing the fieldbus adapter slave

Continued

Removing the fieldbus slot cover (baseline)

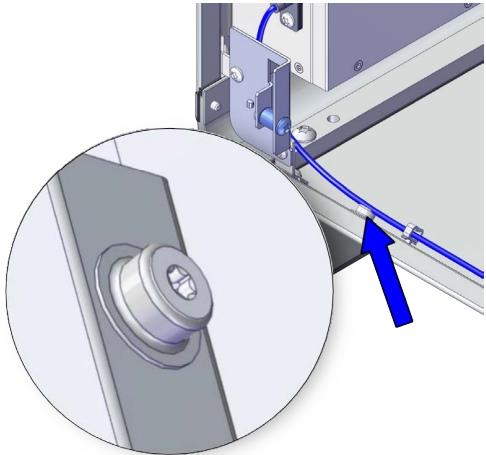
	Action	Note/Illustration
1	 DANGER Before doing any work inside the cabinet, disconnect the mains power. For more information, see Electrical safety on page 31 .	
2	Open the door.	Opening the door on page 188 .
3	 ELECTROSTATIC DISCHARGE (ESD) The unit is sensitive to ESD. Before handling the unit read the safety information in section The unit is sensitive to ESD on page 44 .	Location of wrist strap button:  <small>xx1900001446</small>
4	Remove the fieldbus slot cover with a screwdriver.	



Refitting the fieldbus slot cover (baseline)

	Action	Note/Illustration
1	 DANGER Before doing any work inside the cabinet, disconnect the mains power. For more information, see Electrical safety on page 31 .	

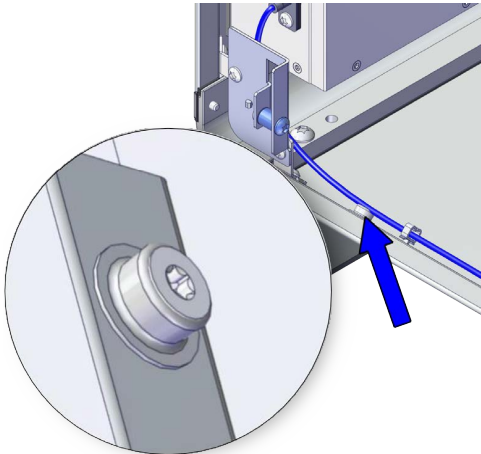
Continues on next page

	Action	Note/Illustration
2	 <p>ELECTROSTATIC DISCHARGE (ESD)</p> <p>The unit is sensitive to ESD. Before handling the unit read the safety information in section The unit is sensitive to ESD on page 44.</p>	<p>Location of wrist strap button:</p>  <p>xx1900001446</p>
3	<p>Push the fieldbus slot cover into the main computer until you hear a clear 'click' sound.</p>	
4	<p>Close the door.</p>	<p>Closing the door on page 188.</p>
5	<p>Perform the function tests to verify that the safety features work properly, see Function tests on page 178.</p>	

Removing the fieldbus adapter slave (option)

	Action	Note/Illustration
1	 <p>DANGER</p> <p>Before doing any work inside the cabinet, disconnect the mains power. For more information, see Electrical safety on page 31.</p>	
2	<p>Open the door.</p>	<p>Opening the door on page 188.</p>
3	 <p>ELECTROSTATIC DISCHARGE (ESD)</p> <p>The unit is sensitive to ESD. Before handling the unit read the safety information in section The unit is sensitive to ESD on page 44.</p>	

Continues on next page



5 Repair

5.3.3 Replacing the fieldbus adapter slave

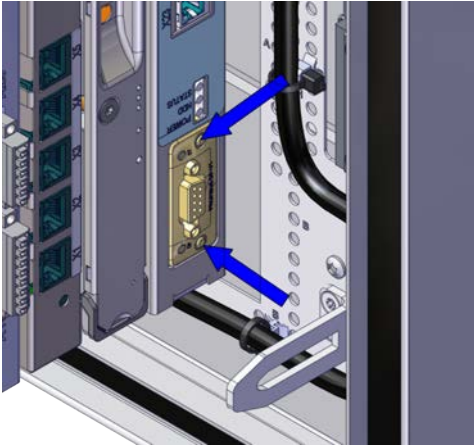
Continued

	Action	Note/Illustration
4	Loosen the screws and take the fieldbus adapter slave out.	 <p data-bbox="924 757 1031 779">xx1900001917</p>

Refitting the fieldbus adapter slave (option)

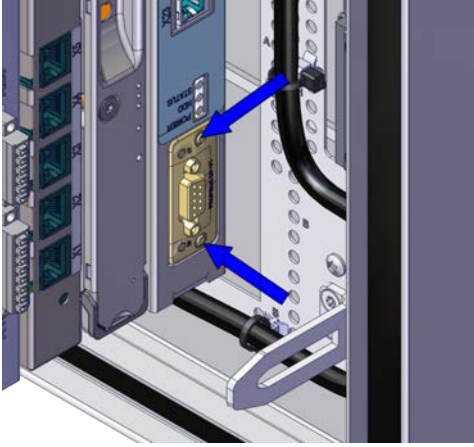
	Action	Note/Illustration
1	 <p data-bbox="560 976 671 1003">DANGER</p> <p data-bbox="469 1034 912 1144">Before doing any work inside the cabinet, disconnect the mains power. For more information, see Electrical safety on page 31.</p>	
2	 <p data-bbox="560 1200 912 1256">ELECTROSTATIC DISCHARGE (ESD)</p> <p data-bbox="469 1276 912 1386">The unit is sensitive to ESD. Before handling the unit read the safety information in section The unit is sensitive to ESD on page 44.</p>	
3	Insert the fieldbus adapter slave tighten the screws.	 <p data-bbox="924 1863 1031 1886">xx1900001917</p>
4	Close the door.	Closing the door on page 188 .

Continues on next page

	Action	Note/Illustration
5	Perform the function tests to verify that the safety features work properly, see Function tests on page 178	

5 Repair

5.3.4 Replacing the incoming mains connector

5.3.4 Replacing the incoming mains connector

Location

The illustration shows the location of the incoming mains connector in the controller.



xx1900001479

Required spare parts



Note

The spare part numbers that are listed in the table can be out of date. See the latest spare parts of the OmniCore C90XT via myABB Business Portal, www.abb.com/myABB.

Spare part	Article number	Note
Harness AC input with SW	3HAC067661-001	Harness-Mains connection
Connector AC power inlet	3HAC070308-001	
Handle for 6 mm switch	3HAC037699-001	

Required tools and equipment

Equipment	Article number	Note
Standard toolkit	-	Content is defined in section Standard toolkit for controller on page 448 .
ESD protective wrist band	-	



Continues on next page

Required documents

Document	Article number	Note
Circuit diagram - OmniCore C90XT	3HAC065464-009	

Removing the incoming mains connector

Preparations

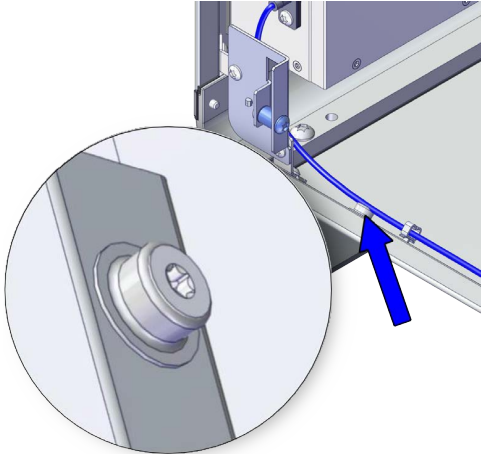
	Action	Note/Illustration
1	 DANGER Before doing any work inside the cabinet, disconnect the mains power. For more information, see Electrical safety on page 31 .	
2	Open the door.	Opening the door on page 188 .
3	 ELECTROSTATIC DISCHARGE (ESD) The unit is sensitive to ESD. Before handling the unit read the safety information in section The unit is sensitive to ESD on page 44 .	Location of wrist strap button:  xx1900001446

Removing the incoming mains connector

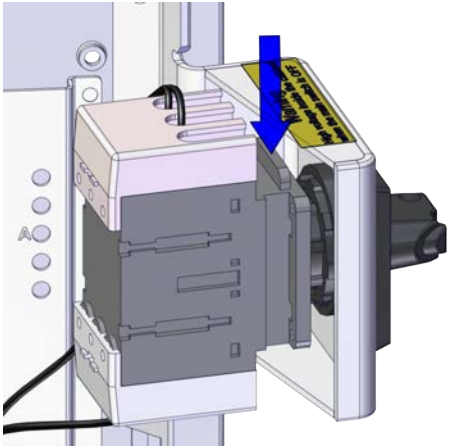
	Action	Note/Illustration
1	Disconnect the mains switch from the handle for 6 switch by pressing the push hook.	 xx1900001919

Continues on next page

5 Repair

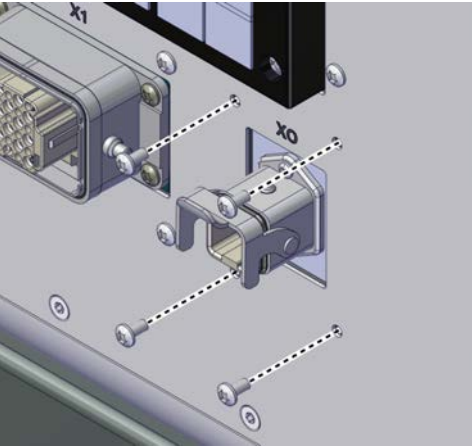

5.3.4 Replacing the incoming mains connector

Continued

	Action	Note/Illustration
2	Disconnect: <ul style="list-style-type: none"> • X0 - Q0. • X0 - A1.X1. • PE.3 & PE.4. 	
3	Remove the attachment screws.	 <p>xx1900001918</p>
4	Push the incoming mains connector into the cabinet.	
5	Take out the incoming mains connector.	

Refitting the incoming mains connector

Refitting the incoming mains connector

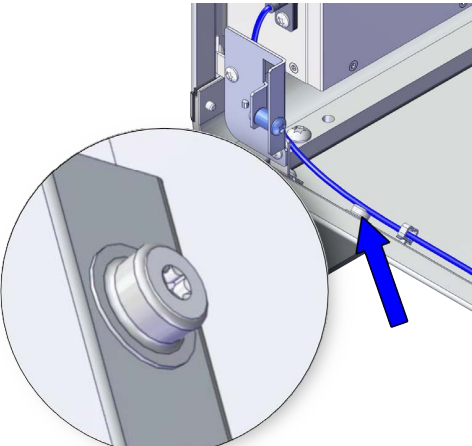
	Action	Note/Illustration
1	 <p>DANGER</p> <p>Before doing any work inside the cabinet, disconnect the mains power. For more information, see Electrical safety on page 31.</p>	
2	 <p>ELECTROSTATIC DISCHARGE (ESD)</p> <p>The unit is sensitive to ESD. Before handling the unit read the safety information in section The unit is sensitive to ESD on page 44.</p>	<p>Location of wrist strap button:</p>  <p>xx1900001446</p>

Continues on next page

5.3.4 Replacing the incoming mains connector
Continued

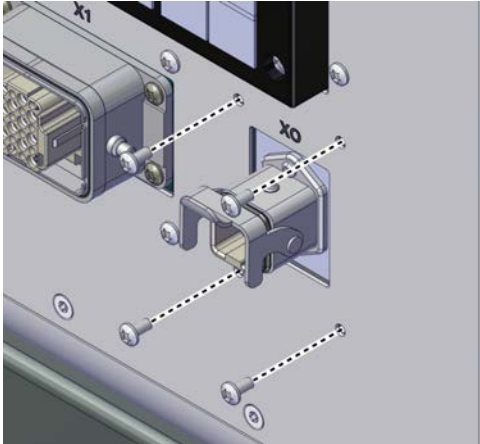
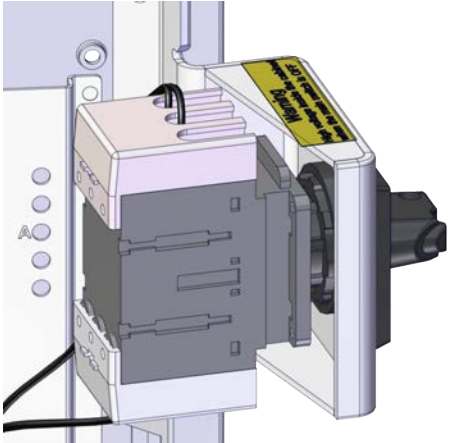
	Action	Note/Illustration
3	Insert the incoming mains connector into the cover of the cabinet.	
4	Secure it with the screws.	<p>Screws: Torx pan head screw M4x8 (4 pcs) Tightening torque: 2.7 Nm±10%.</p>  <p>xx1900001918</p>
5	<p>Reconnect:</p> <ul style="list-style-type: none"> • X0 - Q0. • X0 - A1.X1. • PE.3 & PE.4. 	
6	Reconnect the mains switch to the handle for 6 switch.	 <p>xx1900001920</p>

Concluding procedure

	Action	Note/Illustration
1	Close the door.	Closing the door on page 188.
2	Perform the function tests to verify that the safety features work properly, see Function tests on page 178.	

5 Repair

5.3.5 Replacing the HMI signal (FlexPendant) connector

5.3.5 Replacing the HMI signal (FlexPendant) connector

Location

The illustration shows the location of the HMI signal connector in the controller.



xx1900001475

Required spare parts



Note

The spare part numbers that are listed in the table can be out of date. See the latest spare parts of the OmniCore C90XT via myABB Business Portal, www.abb.com/myABB.

Spare part	Article number	Note
Harness TPU connection	3HAC069673-001	Harness-TPU

Required tools and equipment

Equipment	Article number	Note
Standard toolkit	-	Content is defined in section Standard toolkit for controller on page 448 .
ESD protective wrist band	-	

Continues on next page



5.3.5 Replacing the HMI signal (FlexPendant) connector
Continued

Required documents

Document	Article number	Note
Circuit diagram - OmniCore C90XT	3HAC065464-009	

Removing the HMI signal connector

Preparations

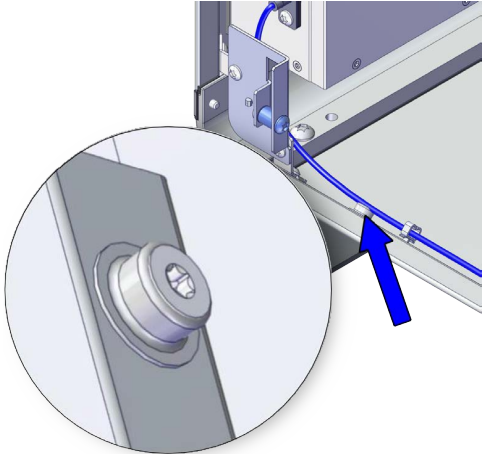
	Action	Note/Illustration
1	 DANGER Before doing any work inside the cabinet, disconnect the mains power. For more information, see Electrical safety on page 31 .	
2	Open the door.	Opening the door on page 188 .
3	 ELECTROSTATIC DISCHARGE (ESD) The unit is sensitive to ESD. Before handling the unit read the safety information in section The unit is sensitive to ESD on page 44 .	Location of wrist strap button:  xx1900001446

Removing the HMI signal connector

	Action	Note/Illustration
1	Remove the cables out from the clips in the cabinet carefully.  Note Make records about the sequence that cables are removed. The cables need to be installed in the same position.	
2	Disconnect: <ul style="list-style-type: none"> • TPU (X4) - K2.X9 & X13 	

Continues on next page

5 Repair

5.3.5 Replacing the HMI signal (FlexPendant) connector

Continued

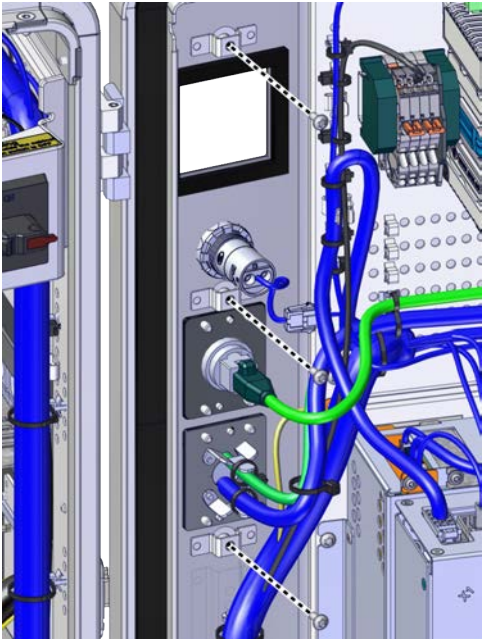
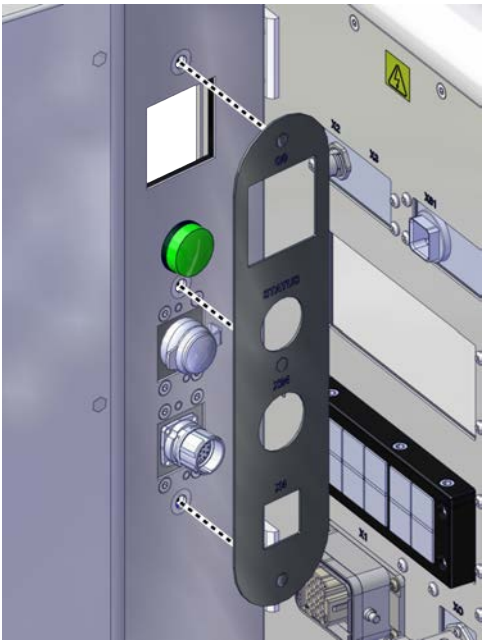
	Action	Note/Illustration
3	Remove the screws.	 <p>xx1900001921</p>
4	Remove the cover plate.	 <p>xx1900001922</p>

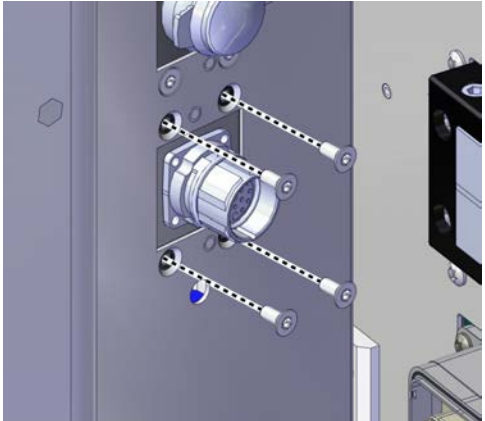

Continues on next page

5.3.5 Replacing the HMI signal (FlexPendant) connector
Continued

	Action	Note/Illustration
5	Remove the attachment screws on the door.	 <p>xx1900001923</p>
6	Push the HMI signal connector into the cabinet.	
7	Take out the HMI signal connector.	

Refitting the HMI signal connector

Refitting the HMI signal connector

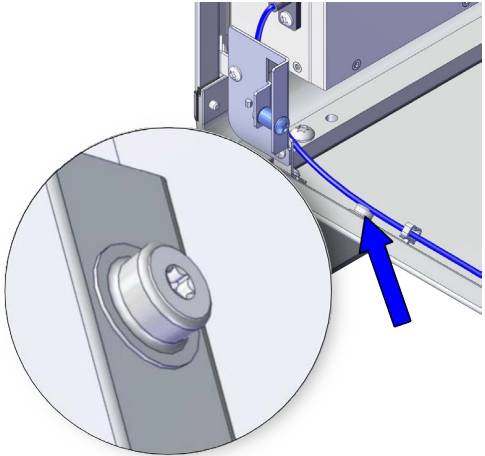

	Action	Note/Illustration
1	 <p>DANGER</p> <p>Before doing any work inside the cabinet, disconnect the mains power. For more information, see Electrical safety on page 31.</p>	
2	 <p>ELECTROSTATIC DISCHARGE (ESD)</p> <p>The unit is sensitive to ESD. Before handling the unit read the safety information in section The unit is sensitive to ESD on page 44.</p>	<p>Location of wrist strap button:</p>  <p>xx1900001446</p>

Continues on next page

5 Repair

5.3.5 Replacing the HMI signal (FlexPendant) connector

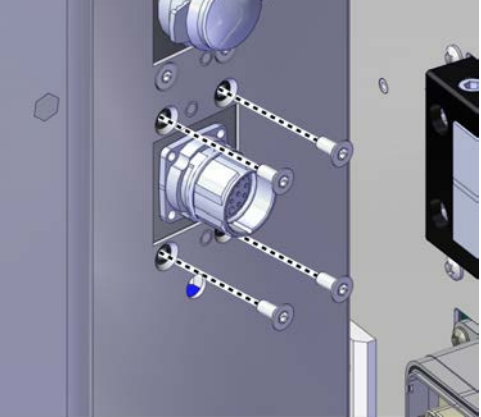
Continued

	Action	Note/Illustration
3	Insert the HMI signal connector into the cover from inside the cabinet. Secure it with the screws.	<p>Screws: Torx, countersunk screw M4x10 (4 pcs) Tightening torque: 1.7 Nm±10%.</p>  <p>xx1900001923</p>
4	Connect: <ul style="list-style-type: none">• TPU (X4) - K2.X9 & X13	
5	Secure the cables on HMI signal connector into the clips on the cabinet.  Tip Use the same position as from removing the HMI signal connector.	
6	Refit the cover plate.	 <p>xx1900001922</p>

Continues on next page

5.3.5 Replacing the HMI signal (FlexPendant) connector
Continued

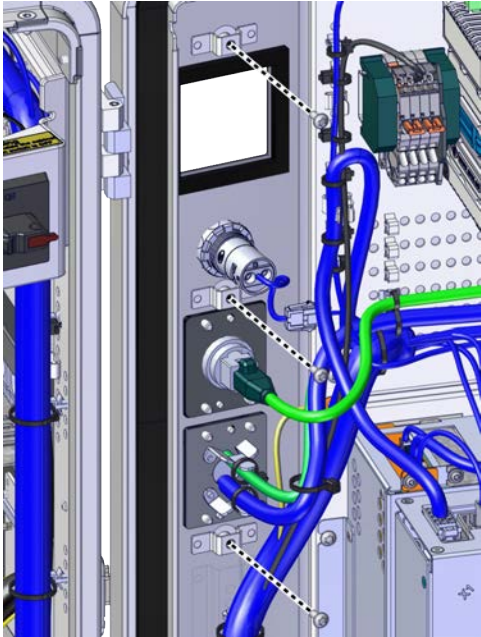
	Action	Note/Illustration
7	Secure it with the screws.	<p>Screws: Torx pan head screw M4x8 (3 pcs) Tightening torque: 1.7 Nm±10%.</p>  <p>xx1900001921</p>

Concluding procedure

	Action	Note/Illustration
1	Close the door.	Closing the door on page 188.
2	Perform the function tests to verify that the safety features work properly, see Function tests on page 178.	

5 Repair

5.3.6 Replacing the cable grommet assembly

5.3.6 Replacing the cable grommet assembly

Location

The illustration shows the location of the cable grommet assembly on the controller.



xx1900001481



Note

The end user needs to install proper grommets according to the diameter of the cables which need to go through the grommet.

Incorrect use of grommets will affect ingress protection, EMI/EMC and temperature.

It is recommended to use icotek KT grommet.

Required spare parts



Note

The spare part numbers that are listed in the table can be out of date. See the latest spare parts of the OmniCore C90XT via myABB Business Portal, www.abb.com/myABB.

Continues on next page

5.3.6 Replacing the cable grommet assembly
Continued

Spare part	Article number	Note
Cable grommet asm	3HAC066396-001	

Required tools and equipment



Equipment	Article number	Note
Standard toolkit	-	Content is defined in section Standard toolkit for controller on page 448 .
ESD protective wrist band	-	

Required documents

Document	Article number	Note
Circuit diagram - OmniCore C90XT	3HAC065464-009	

Removing the cable grommet assembly

Preparations

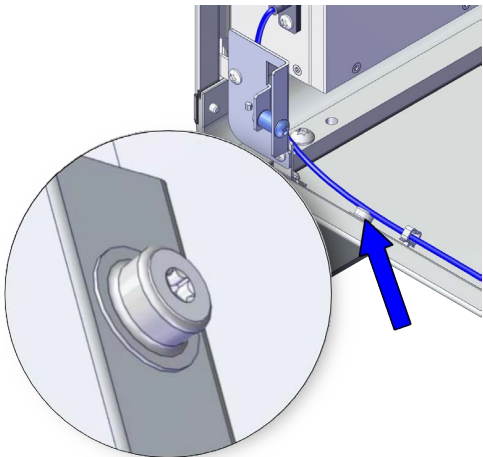
	Action	Note/Illustration
1	 <p>DANGER</p> <p>Before doing any work inside the cabinet, disconnect the mains power. For more information, see Electrical safety on page 31.</p>	
2	Open the door.	Opening the door on page 188 .
3	 <p>ELECTROSTATIC DISCHARGE (ESD)</p> <p>The unit is sensitive to ESD. Before handling the unit read the safety information in section The unit is sensitive to ESD on page 44.</p>	<p>Location of wrist strap button:</p>  <p>xx1900001446</p>

Continues on next page

5 Repair

5.3.6 Replacing the cable grommet assembly

Continued

Removing the cable grommet assembly

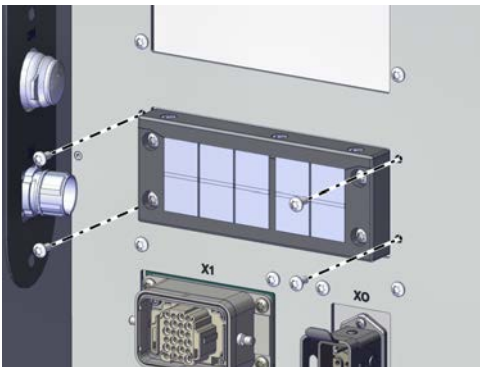
	Action	Note/Illustration
1	Remove the cables out from the clips in the cabinet carefully.  Note Make records about the sequence that cables are removed. The cables need to be installed in the same position.	
2	Remove the attachment screws on the cover.	 xx1900002340
3	Push the cable grommet assembly into the cabinet.	
4	Take the cable grommet assembly out.	

Releasing the cables from the cable grommet assembly

	Action	Note/Illustration
1	Unscrew the cable entry frame from the enclosure wall.	 xx1900002332

Continues on next page

5.3.6 Replacing the cable grommet assembly
Continued

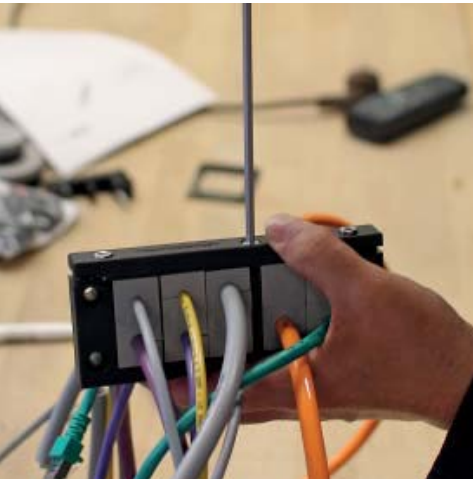
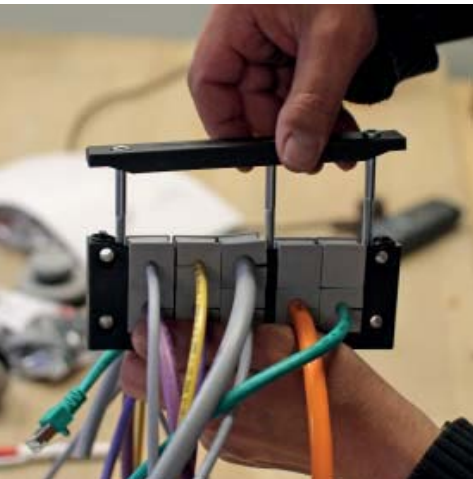

	Action	Note/Illustration
2	Take out the cables with the cable entry frame through the cut-out.	 xx1900002333
3	Remove the attachment screws on the frame and cover strip.	 xx1900002334
4	Remove the cover strip from the frame.	 xx1900002335

Continues on next page

5 Repair

5.3.6 Replacing the cable grommet assembly

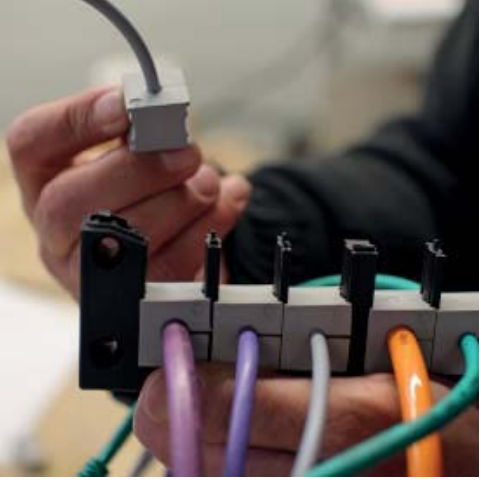

Continued

	Action	Note/Illustration
5	<p>Take out the grommets with the cables that need to be removed one by one.</p> <p> Tip</p> <p>Remove the grommets in the upper row first and then the second row.</p>	 <p>xx1900002336</p>
6	<p>Remove the cable from the corresponding KT grommet.</p>	 <p>xx1900002337</p>

Continues on next page

Refitting the cable grommet assembly

Refitting the cables to the cable grommet assembly

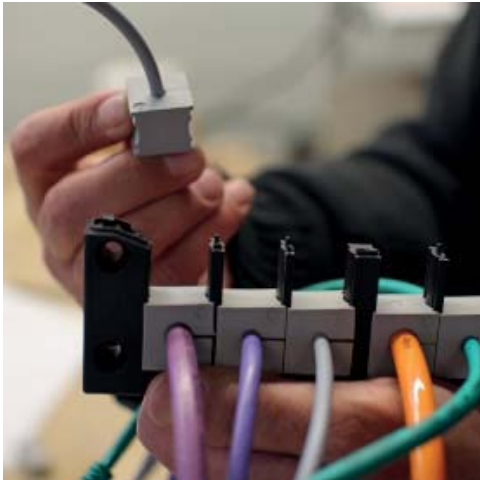
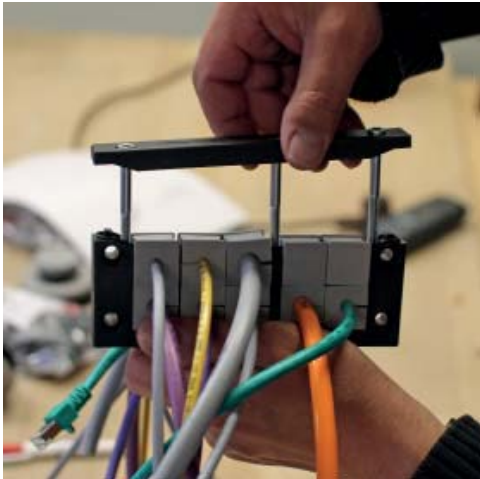

	Action	Note/Illustration
1	Insert and equip the cable to the corresponding KT grommet.	 <p data-bbox="954 907 1061 929">xx1900002337</p>
2	Slide the grommets into the frame halves.  Note It must be ensured that the flat side of the grommets in the lower row are pointing to the open side of the frame half (flat sides pointing upwards).  Note The flat side of the grommets in the upper row have to point downwards so that all flat sides rest on each other. When using single row frames the flat side has to point towards the cover strip.	 <p data-bbox="954 1453 1061 1476">xx1900002336</p>
3	Refit the cover strip onto the frame.	 <p data-bbox="954 1998 1061 2020">xx1900002335</p>

Continues on next page

5 Repair

5.3.6 Replacing the cable grommet assembly

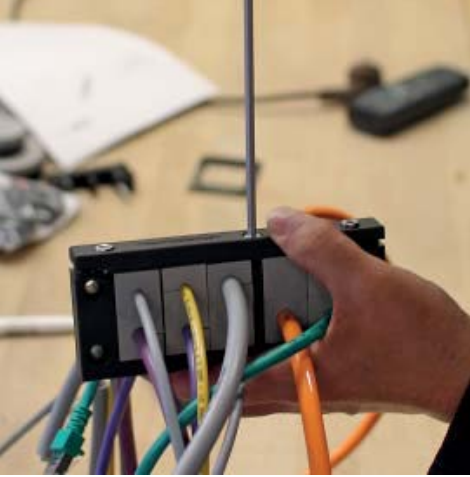
Continued



	Action	Note/Illustration
4	Secure the frame and cover strip with the screws.	<p data-bbox="927 315 1398 405">Screws: Hex socket head cap screw M5x50 12.9 Lafre 2C2B/FC6.9 (3 pcs) Tightening torque: 2 Nm - 3 Nm.</p>  <p data-bbox="927 898 1031 920">xx1900002334</p>
5	Route the cables through the cut-out.	 <p data-bbox="927 1442 1031 1464">xx1900002333</p>

Continues on next page

5.3.6 Replacing the cable grommet assembly
Continued

	Action	Note/Illustration
6	Refit the cable entry frame to the enclosure wall and secure with the screws.	<p>Screws: Torx pan head screw M4x8 (4 pcs) Tightening torque: 1.5 Nm.</p>  <p>xx1900002332</p>

Refitting the cable grommet assembly

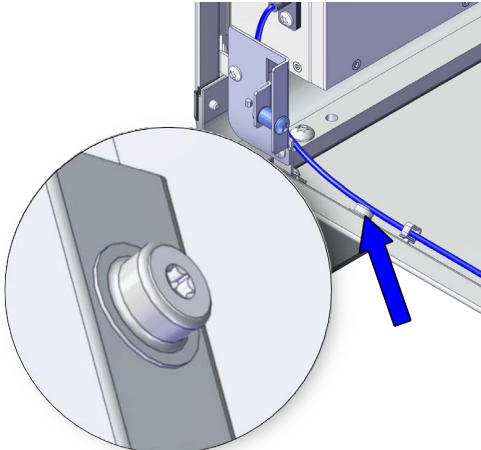
	Action	Note/Illustration
1	 <p>DANGER</p> <p>Before doing any work inside the cabinet, disconnect the mains power. For more information, see Electrical safety on page 31.</p>	
2	 <p>ELECTROSTATIC DISCHARGE (ESD)</p> <p>The unit is sensitive to ESD. Before handling the unit read the safety information in section The unit is sensitive to ESD on page 44.</p>	<p>Location of wrist strap button:</p>  <p>xx1900001446</p>

Continues on next page

5 Repair

5.3.6 Replacing the cable grommet assembly

Continued

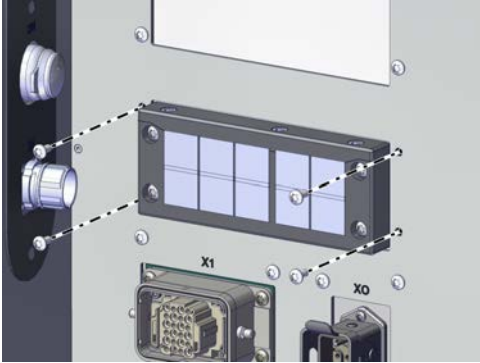
	Action	Note/Illustration
3	Insert the cable grommet assembly into the cover of the cabinet. Secure it with the screws.	Screws: Torx pan head screw M4x8 (4 pcs) Tightening torque: 2.7 Nm±10%.  xx1900002340

Concluding procedure

	Action	Note/Illustration
1	Close the door.	Closing the door on page 188.
2	Perform the function tests to verify that the safety features work properly, see Function tests on page 178.	

5.3.7 Replacing the cable grommet assembly

Location

The illustration shows the location of the cable grommet assembly on the controller.



xx1900001480



Note

The end user needs to install proper grommets according to the diameter of the cables which need to go through the grommet.

Incorrect use of grommets will affect ingress protection, EMI/EMC and temperature.

It is recommended to use icotek KT grommet.

Required spare parts



Note

The spare part numbers that are listed in the table can be out of date. See the latest spare parts of the OmniCore C90XT via myABB Business Portal, www.abb.com/myABB.

Continues on next page

5 Repair

5.3.7 Replacing the cable grommet assembly

Continued

Spare part	Article number	Note
Blind plate	3HAC069954-001	
Cable grommet asm	3HAC066396-001	

Required tools and equipment



Equipment	Article number	Note
Standard toolkit	-	Content is defined in section Standard toolkit for controller on page 448 .
ESD protective wrist band	-	

Required documents

Document	Article number	Note
<i>Circuit diagram - OmniCore C90XT</i>	3HAC065464-009	

Removing the cable grommet assembly

Preparations

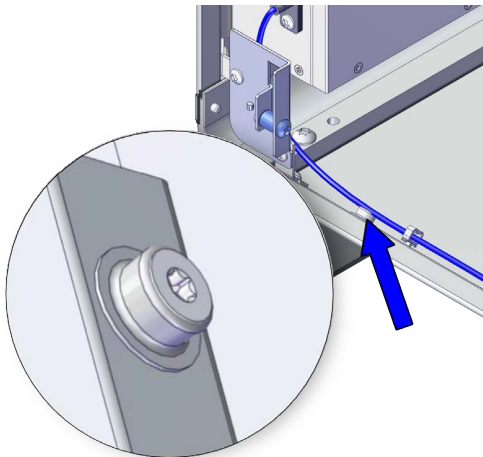
	Action	Note/Illustration
1	 DANGER Before doing any work inside the cabinet, disconnect the mains power. For more information, see Electrical safety on page 31 .	
2	Open the door.	Opening the door on page 188 .
3	 ELECTROSTATIC DISCHARGE (ESD) The unit is sensitive to ESD. Before handling the unit read the safety information in section The unit is sensitive to ESD on page 44 .	Location of wrist strap button:  xx1900001446

Continues on next page

Removing the cable grommet assembly

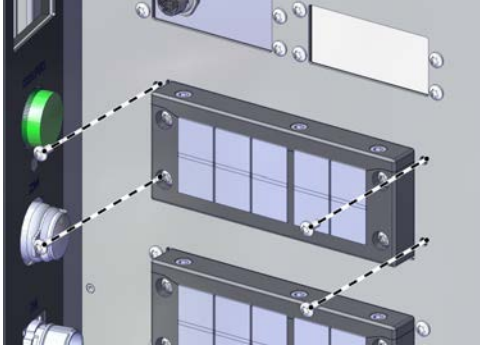
	Action	Note/Illustration
1	Remove the cables out from the clips in the cabinet carefully.  Note Make records about the sequence that cables are removed. The cables need to be installed in the same position.	
2	Remove the attachment screws on the cover.	 <p>xx1900002445</p>
3	Push the cable grommet assembly into the cabinet.	
4	Take the cable grommet assembly out.	

Releasing the cables from the cable grommet assembly

	Action	Note/Illustration
1	Unscrew the cable entry frame from the enclosure wall.	 <p>xx1900002332</p>

Continues on next page

5 Repair

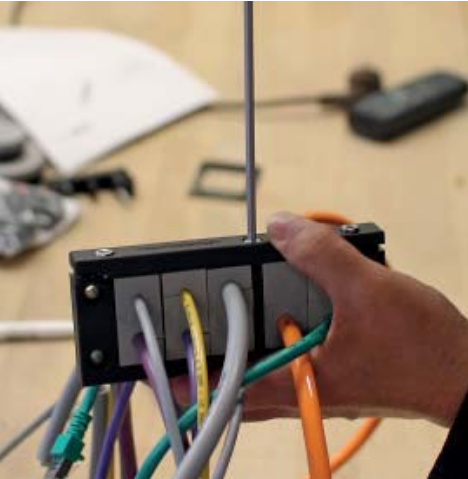
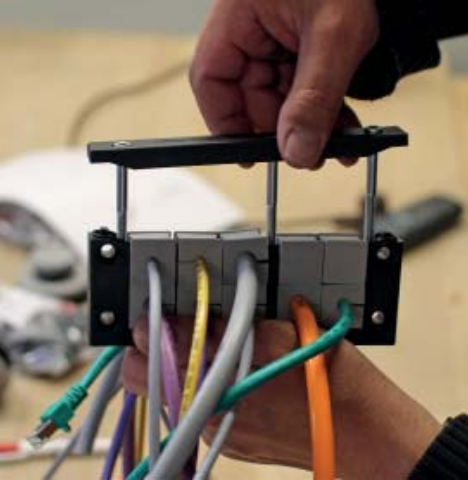

5.3.7 Replacing the cable grommet assembly

Continued

	Action	Note/Illustration
2	Take out the cables with the cable entry frame through the cut-out.	 xx1900002333
3	Remove the attachment screws on the frame and cover strip together.	 xx1900002334
4	Remove the cover strip from the frame.	 xx1900002335

Continues on next page

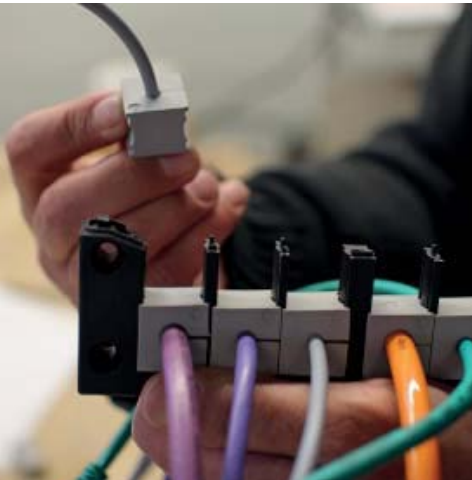
5.3.7 Replacing the cable grommet assembly
Continued

	Action	Note/Illustration
5	<p>Take out the grommets with the cables that need to be removed one by one.</p> <p> Tip</p> <p>Remove the grommets in the upper row first and then the second row.</p>	 <p>xx1900002336</p>
6	<p>Remove the cable from the corresponding KT grommet.</p>	 <p>xx1900002337</p>

Continues on next page



5 Repair

5.3.7 Replacing the cable grommet assembly

Continued

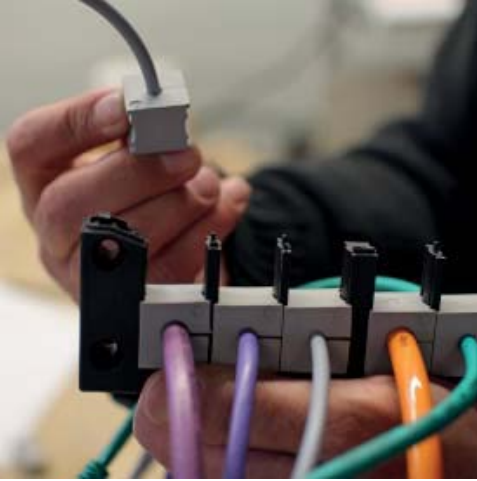
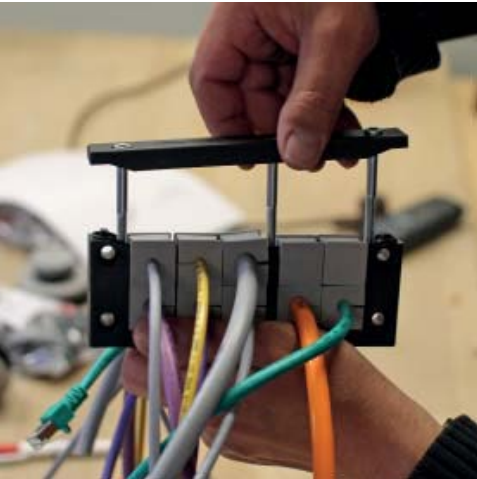

Refitting the cable grommet assembly

Refitting the cables to the cable grommet assembly

	Action	Note/Illustration
1	Insert and equip the cable to the corresponding KT grommet.	 <p data-bbox="927 909 1034 927">xx1900002337</p>
2	<p data-bbox="475 965 911 994">Slide the grommets into the frame halves.</p> <p data-bbox="475 1010 533 1066"> Note</p> <p data-bbox="475 1081 911 1189">It must be ensured that the flat side of the grommets in the lower row are pointing to the open side of the frame half (flat sides pointing upwards).</p> <p data-bbox="475 1205 533 1261"> Note</p> <p data-bbox="475 1276 911 1413">The fl at side of the grommets in the upper row have to point downwards so that all flat sides rest on each other. When using single row frames the fl at side has to point towards the cover strip.</p>	 <p data-bbox="927 1458 1034 1476">xx1900002336</p>
3	Refit the cover strip onto the frame.	 <p data-bbox="927 2000 1034 2018">xx1900002335</p>

Continues on next page

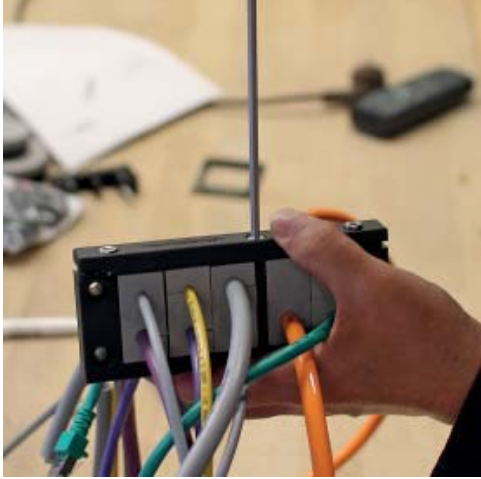
5.3.7 Replacing the cable grommet assembly
Continued

	Action	Note/Illustration
4	Secure the frame and cover strip with the screws.	<p>Screws: Hex socket head cap screw M5x50 12.9 Lafre 2C2B/FC6.9 (3 pcs) Tightening torque: 2 Nm - 3 Nm.</p>  <p>xx1900002334</p>
5	Route the cables through the cut-out.	 <p>xx1900002333</p>

Continues on next page



5 Repair

5.3.7 Replacing the cable grommet assembly

Continued

	Action	Note/Illustration
6	Refit the cable entry frame to the enclosure wall and secure with the screws.	<p>Screws: Torx pan head screw M4x8 (4 pcs) Tightening torque: 1.5 Nm.</p>  <p>xx1900002332</p>

Refitting the cable grommet assembly

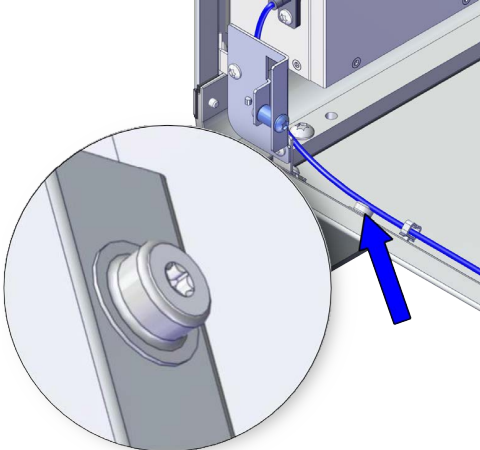
	Action	Note/Illustration
1	 <p>DANGER</p> <p>Before doing any work inside the cabinet, disconnect the mains power. For more information, see Electrical safety on page 31.</p>	
2	 <p>ELECTROSTATIC DISCHARGE (ESD)</p> <p>The unit is sensitive to ESD. Before handling the unit read the safety information in section The unit is sensitive to ESD on page 44.</p>	<p>Location of wrist strap button:</p>  <p>xx1900001446</p>

Continues on next page

5.3.7 Replacing the cable grommet assembly
Continued

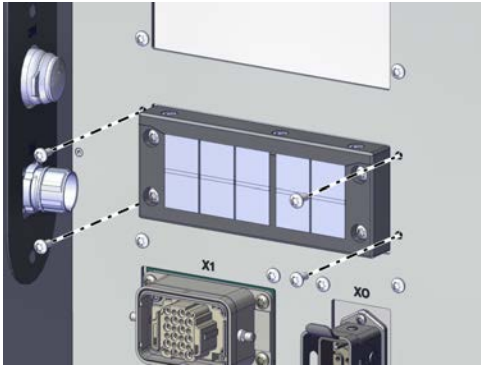
	Action	Note/Illustration
3	Insert the cable grommet assembly into the cover of the cabinet. Secure it with the screws.	Screws: Torx pan head screw M4x8 (4 pcs)  xx1900002340

Concluding procedure

	Action	Note/Illustration
1	Close the door.	Closing the door on page 188.
2	Perform the function tests to verify that the safety features work properly, see Function tests on page 178.	

5 Repair

5.3.8 Replacing the Ethernet outlet connector with cable

5.3.8 Replacing the Ethernet outlet connector with cable

Location

The illustration shows the location of the Ethernet outlet connector with cable.



xx1900001482

Required spare parts



Note

The spare part numbers that are listed in the table can be out of date. See the latest spare parts of the OmniCore C90XT via myABB Business Portal, www.abb.com/myABB.

Spare part	Article number	Note
Harness ETH outlet with cable	3HAC070053-001	

Required tools and equipment

Equipment	Article number	Note
Standard toolkit	-	Content is defined in section Standard toolkit for controller on page 448 .
ESD protective wrist band	-	

Continues on next page



5.3.8 Replacing the Ethernet outlet connector with cable
Continued

Required documents

Document	Article number	Note
Circuit diagram - OmniCore C90XT	3HAC065464-009	

Removing the Ethernet outlet connector with cable

Preparations

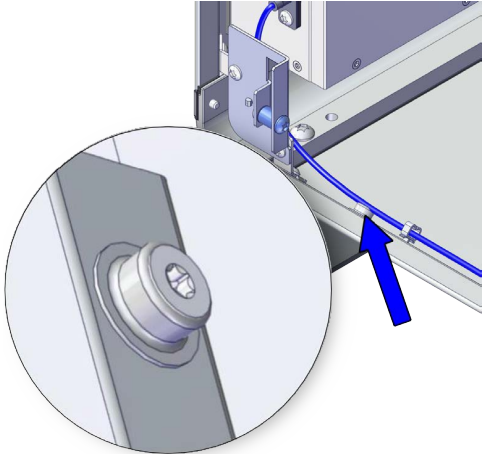
	Action	Note/Illustration
1	 <p>DANGER</p> <p>Before doing any work inside the cabinet, disconnect the mains power. For more information, see Electrical safety on page 31.</p>	
2	Open the door.	Opening the door on page 188 .
3	 <p>ELECTROSTATIC DISCHARGE (ESD)</p> <p>The unit is sensitive to ESD. Before handling the unit read the safety information in section The unit is sensitive to ESD on page 44.</p>	<p>Location of wrist strap button:</p>  <p>xx1900001446</p>



Continues on next page

5 Repair

5.3.8 Replacing the Ethernet outlet connector with cable

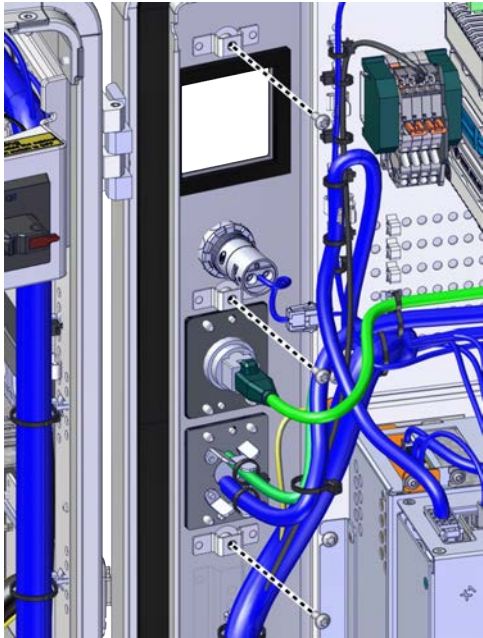

Continued

Removing the Ethernet outlet connector with cable

	Action	Note/Illustration
1	Remove the screws.	 <p>xx1900001921</p>
2	Remove the cover plate.	 <p>xx1900001922</p>

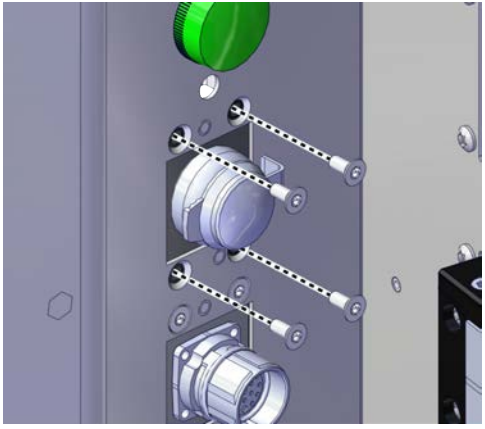

Continues on next page

5.3.8 Replacing the Ethernet outlet connector with cable
Continued

	Action	Note/Illustration
3	Remove the attachment screws on the door.	 <p>xx1900001924</p>
4	Push the Ethernet outlet connector with cable into the cabinet.	
5	Disconnect: <ul style="list-style-type: none"> • X24 - A2.X3 	
6	Remove the cables out from the clips in the cabinet carefully.  Note Make records about the sequence that cables are removed. The cables need to be installed in the same position.	
7	Take the Ethernet outlet connector with cable out from the upper side.	

Refitting the Ethernet outlet connector with cable

Refitting the Ethernet outlet connector with cable



	Action	Note/Illustration
1	 DANGER Before doing any work inside the cabinet, disconnect the mains power. For more information, see Electrical safety on page 31 .	
2	 ELECTROSTATIC DISCHARGE (ESD) The unit is sensitive to ESD. Before handling the unit read the safety information in section The unit is sensitive to ESD on page 44 .	
3	Insert the Ethernet outlet connector with cable into the cover from inner side of the cabinet.	

Continues on next page

5 Repair

5.3.8 Replacing the Ethernet outlet connector with cable

Continued

	Action	Note/Illustration
4	Secure it with the attachment screws.	<p>Screws: Torx, countersunk screw M4x10 (4 pcs)</p>  <p>xx1900001924</p>
5	Connect: <ul style="list-style-type: none">• X24 - A2.X3	
6	Secure the Ethernet outlet connector with cables with the clips on the cabinet.  Tip Use the same position as from removing the harness ETH outlet with cable.	
7	Refit the cover plate.	 <p>xx1900001922</p>

Continues on next page

5.3.8 Replacing the Ethernet outlet connector with cable

Continued

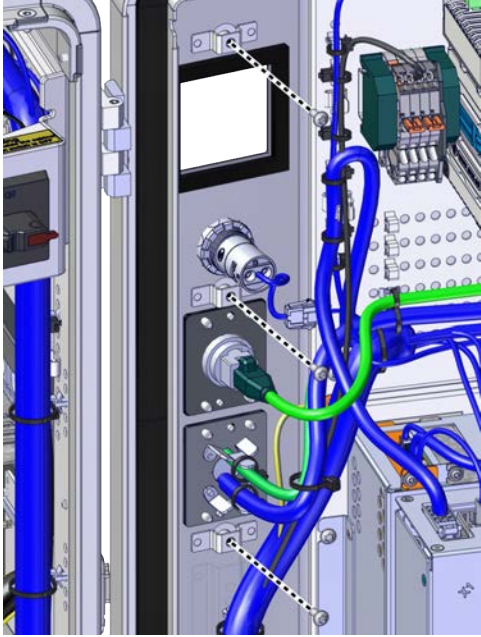
	Action	Note/Illustration
8	Secure it with the screws.	<p>Screws: Torx pan head screw M4x8 (3 pcs)</p>  <p>xx1900001921</p>

Concluding procedure

	Action	Note/Illustration
1	Close the door.	<i>Closing the door on page 188.</i>
2	Perform the function tests to verify that the safety features work properly, see <i>Function tests on page 178.</i>	

5 Repair

5.3.9 Replacing the LED indicator

5.3.9 Replacing the LED indicator

Location

The illustration shows the location of the LED indicator.



xx1900001483

Required spare parts



Note

The spare part numbers that are listed in the table can be out of date. See the latest spare parts of the OmniCore C90XT via myABB Business Portal, www.abb.com/myABB.

Spare part	Article number	Note
LED indicator	3HAC065549-001	

Required tools and equipment

Equipment	Article number	Note
Standard toolkit	-	Content is defined in section Standard toolkit for controller on page 448 .
ESD protective wrist band	-	



Continues on next page

Required documents

Document	Article number	Note
Circuit diagram - OmniCore C90XT	3HAC065464-009	

Removing the LED indicator

Preparations

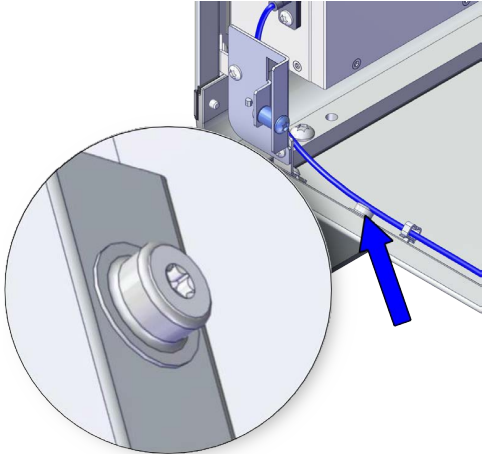
	Action	Note/Illustration
1	 DANGER Before doing any work inside the cabinet, disconnect the mains power. For more information, see Electrical safety on page 31 .	
2	Open the door.	Opening the door on page 188 .
3	 ELECTROSTATIC DISCHARGE (ESD) The unit is sensitive to ESD. Before handling the unit read the safety information in section The unit is sensitive to ESD on page 44 .	Location of wrist strap button:  xx1900001446



Continues on next page

5 Repair

5.3.9 Replacing the LED indicator

Continued

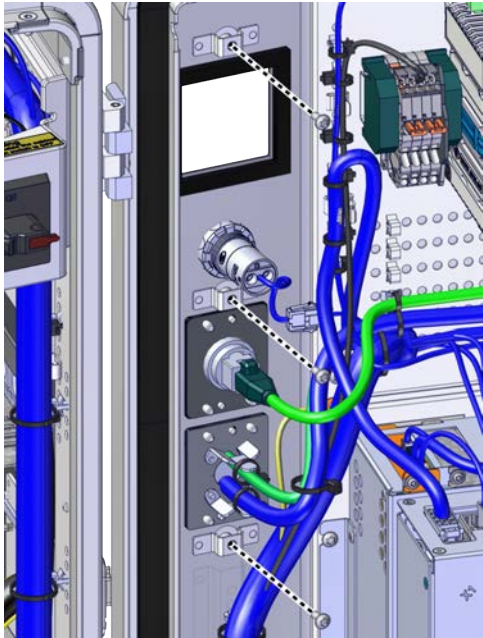
Removing the LED indicator

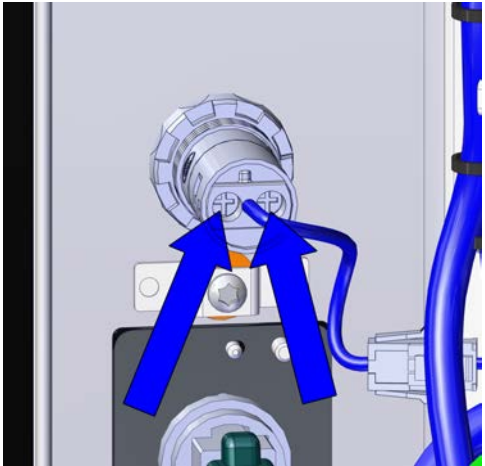

	Action	Note/Illustration
1	Remove the screws.	 <p>xx1900001921</p>
2	Remove the cover plate.	 <p>xx1900001922</p>

Continues on next page

	Action	Note/Illustration
3	Loose the attachment screws locking the cable.	 <p>xx1900001926</p>
4	Remove the terminals (X1&X2) of the cable from the lamp.	
5	Turn the MON_LAMP screw anti-clockwise to remove the screw.	
6	Take the LED indicator out.	

Refitting the LED indicator

Refitting the LED indicator

	Action	Note/Illustration
1	 <p>DANGER</p> <p>Before doing any work inside the cabinet, disconnect the mains power. For more information, see Electrical safety on page 31.</p>	
2	 <p>ELECTROSTATIC DISCHARGE (ESD)</p> <p>The unit is sensitive to ESD. Before handling the unit read the safety information in section The unit is sensitive to ESD on page 44.</p>	
3	Insert the LED indicator into the cover from outer side of the door and the screw from inner side and screw them up.	

Continues on next page

5 Repair

5.3.9 Replacing the LED indicator

Continued

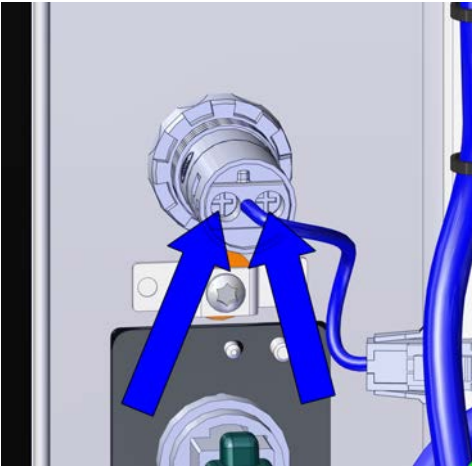
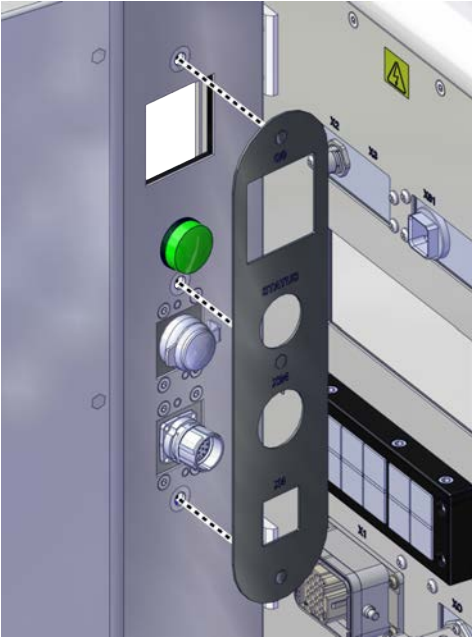
	Action	Note/Illustration
4	Insert the terminals (X1 & X2) of cables into the lamp and secure with the screws.	 <p>The illustration shows a close-up of a lamp assembly with two terminals labeled X1 and X2. Two blue cables are being inserted into these terminals. Two blue arrows point to the terminals. Below the illustration is the reference code xx1900001926.</p>
5	Refit the cover plate.	 <p>The illustration shows a grey metal cover plate being refitted to a device. The cover plate has several circular and rectangular cutouts. A green button is visible on the left side of the cover plate. Below the illustration is the reference code xx1900001922.</p>

Continues on next page

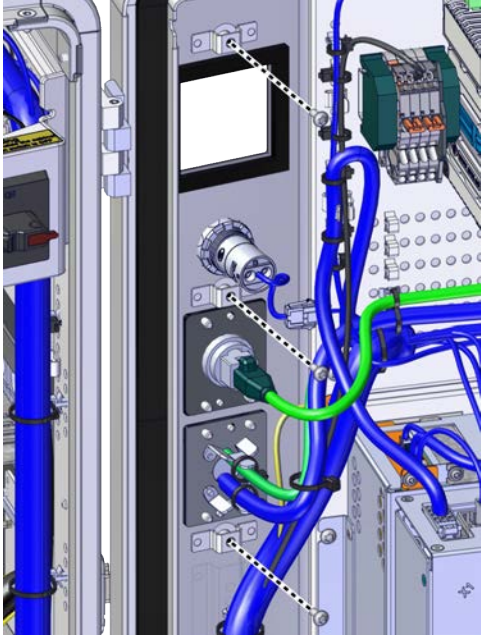
	Action	Note/Illustration
6	Secure it with the screws.	<p>Screws: Torx pan head screw M4x8 (3 pcs)</p>  <p>xx1900001921</p>

Concluding procedure

	Action	Note/Illustration
1	Close the door.	<i>Closing the door on page 188.</i>
2	Perform the function tests to verify that the safety features work properly, see <i>Function tests on page 178.</i>	

5 Repair

5.4.1 Replacing the power cable and power cable cover

5.4 Replacing parts on the FlexPendant

5.4.1 Replacing the power cable and power cable cover

Location

The illustration shows the location of the power cable, power cable gasket, and power cable cover in the FlexPendant.

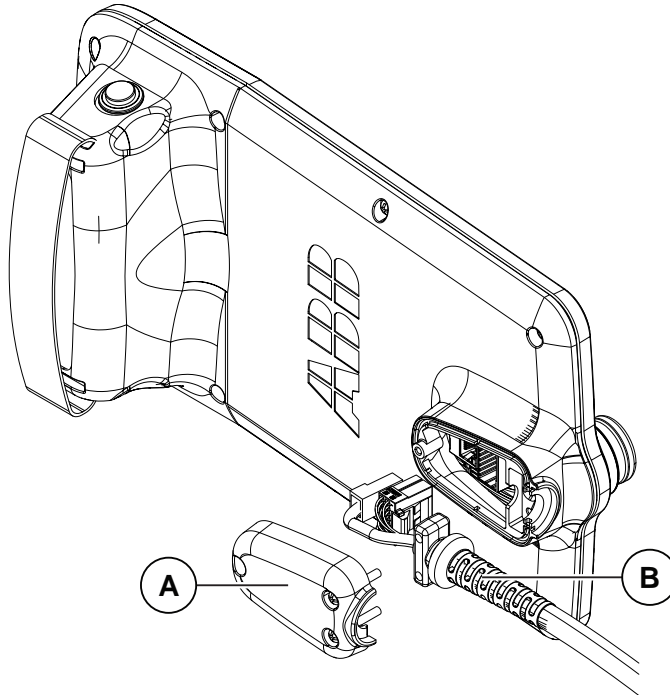

xx1800001154

A	Power cable cover
B	Power cable

Required spare parts



Note

The spare part numbers that are listed in the table can be out of date. See the latest spare parts of the OmniCore C90XT via myABB Business Portal, www.abb.com/myABB.

Spare part	Article number	Note
FlexPendant	3HAC086996-001	DSQC3124
Power cable cover	3HAC065401-001	
FlexPendant power cable 3 m	3HAC064448-002	
FlexPendant power cable 10 m	3HAC064448-001	

Continues on next page

5.4.1 Replacing the power cable and power cable cover

Continued

Required tools and equipment

Equipment	Article number	Note
Standard toolkit	-	Content is defined in section Standard toolkit for controller on page 448 .
ESD protective wrist band	-	

Required documents

Document	Article number	Note
<i>Circuit diagram - OmniCore C90XT</i>	3HAC065464-009	

Removing the power cable and power cable cover

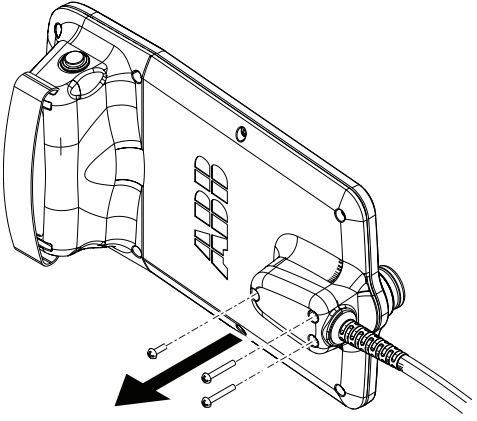
	Action	Note/Illustration
1	 ELECTROSTATIC DISCHARGE (ESD) The unit is sensitive to ESD. Before handling the unit read the safety information in section The unit is sensitive to ESD on page 44 .	
2	Disconnect the FlexPendant from the controller.	
3	Remove the attachment screws for the power cable cover.	 <p>xx1800001189</p>

Continues on next page

5 Repair

5.4.1 Replacing the power cable and power cable cover

Continued

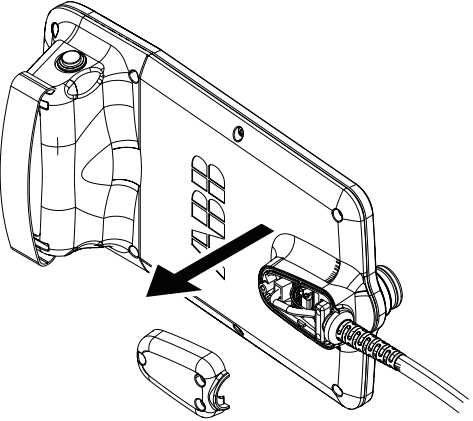
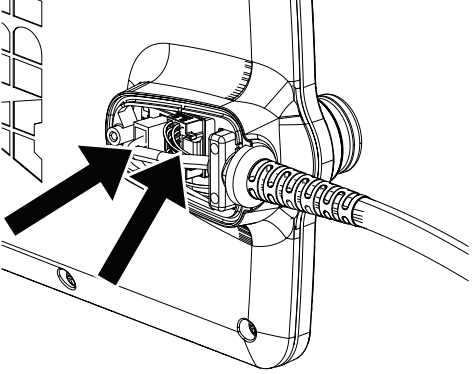
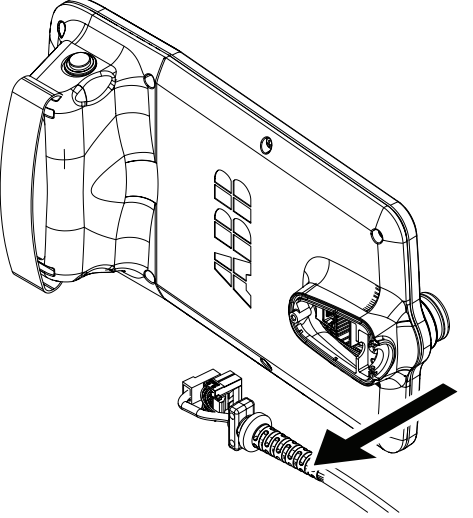
	Action	Note/Illustration
4	Remove the power cable cover.	 <p>xx1800001190</p>
5	Disconnect two connectors to the FlexPendant.	 <p>xx1800001748</p>
6	Remove the power cable.	 <p>xx1800001192</p>

Continues on next page

Refitting the power cable and power cable cover

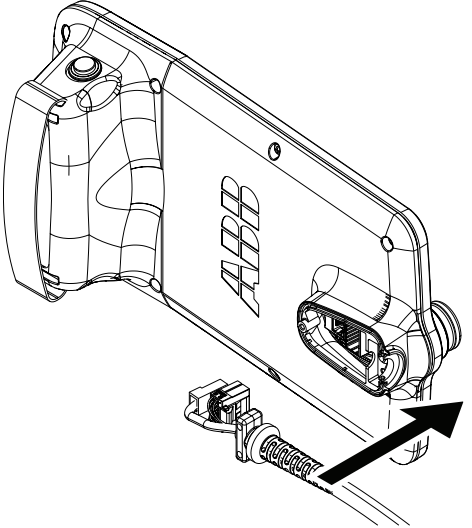
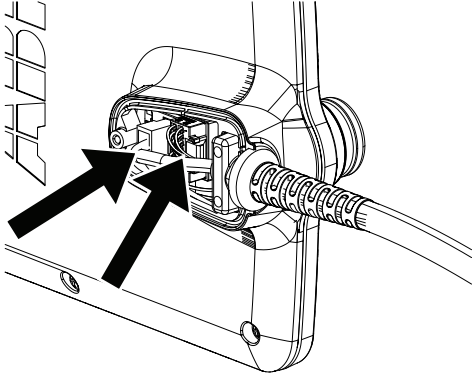
	Action	Note/Illustration
1	 <p>ELECTROSTATIC DISCHARGE (ESD)</p> <p>The unit is sensitive to ESD. Before handling the unit read the safety information in section <i>The unit is sensitive to ESD on page 44</i>.</p>	
2	Refit the power cable.	 <p>xx1800001193</p>
3	Reconnect the power cable to the Flex-Pendant.	 <p>xx1800001748</p>

Continues on next page

5 Repair

5.4.1 Replacing the power cable and power cable cover

Continued

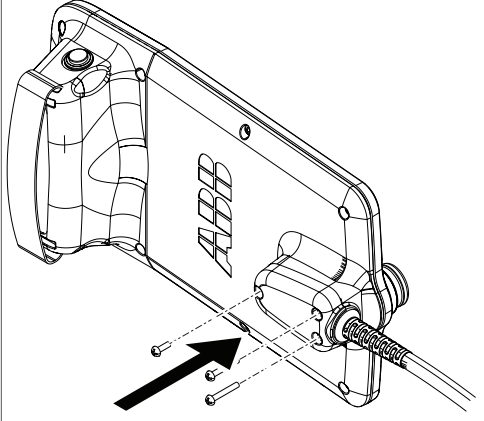
	Action	Note/Illustration
4	Refit the power cable cover and tighten the screws.	<p data-bbox="920 315 1406 344">Screws: Torx pan head screw M4x8 (3 pcs)</p>  <p data-bbox="920 763 1034 792">xx1800001196</p>
5	Perform the function tests to verify that the safety features work properly, see Function tests on page 178 .	

5.4.2 Replacing the joystick protection

Location

The illustration shows the location of the joystick protection on the FlexPendant.

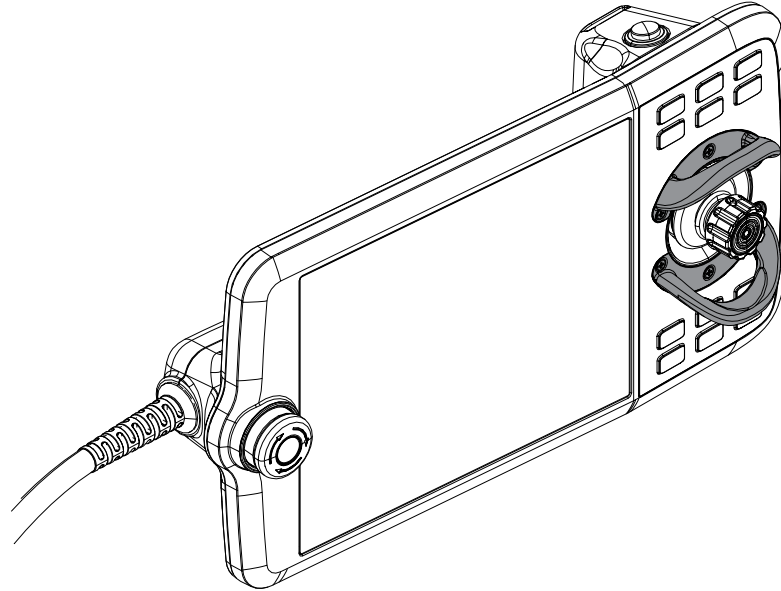

xx1800001197

Required spare parts



Note

The spare part numbers that are listed in the table can be out of date. See the latest spare parts of the OmniCore C90XT via myABB Business Portal, www.abb.com/myABB.

Spare part	Article number	Note
Joystick guard	3HAC065408-001	

Required tools and equipment

Equipment	Article number	Note
Standard toolkit	-	Content is defined in section Standard toolkit for controller on page 448 .

Required documents

Document	Article number	Note
<i>Circuit diagram - OmniCore C90XT</i>	3HAC065464-009	

Continues on next page

5 Repair

5.4.2 Replacing the joystick protection

Continued

Removing the joystick protection

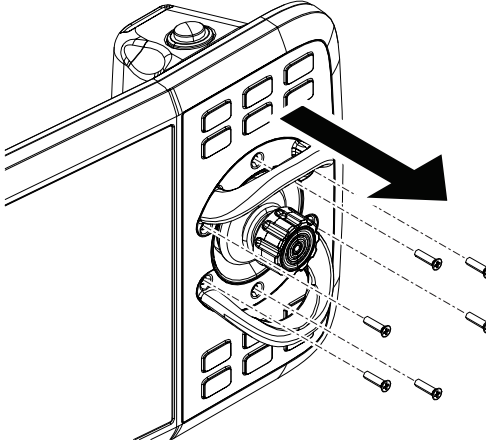
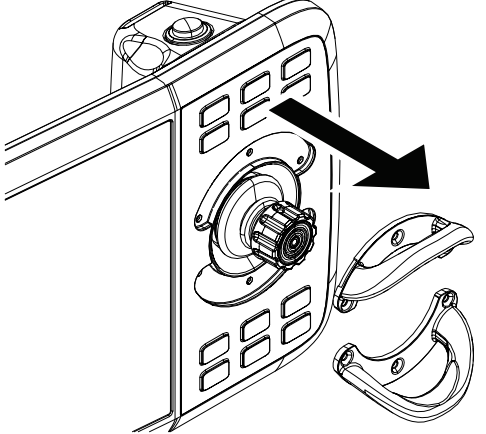
	Action	Note/Illustration
1	 ELECTROSTATIC DISCHARGE (ESD) The unit is sensitive to ESD. Before handling the unit read the safety information in section <i>The unit is sensitive to ESD on page 44</i> .	
2	Disconnect the FlexPendant from the controller.	
3	Remove the attachment screws.	 xx1800001198
4	Remove the joystick protection.	 xx1800001199

Refitting the joystick protection

	Action	Note/Illustration
1	 ELECTROSTATIC DISCHARGE (ESD) The unit is sensitive to ESD. Before handling the unit read the safety information in section <i>The unit is sensitive to ESD on page 44</i> .	

Continues on next page

5.4.2 Replacing the joystick protection
Continued

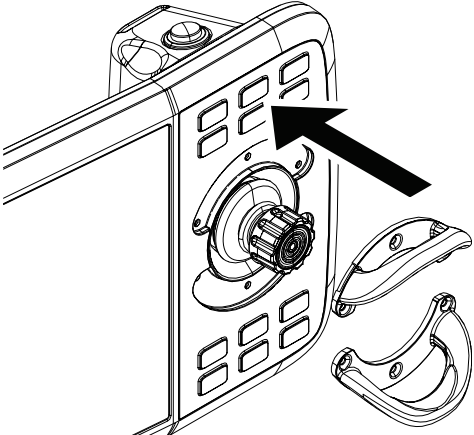
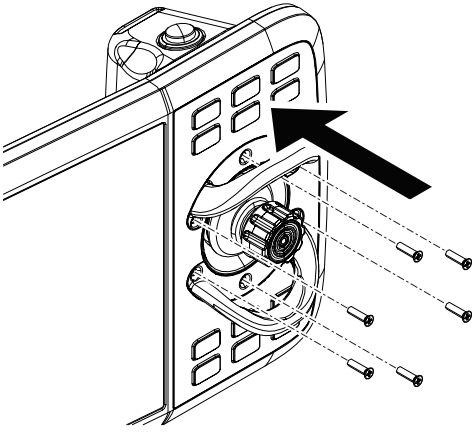
	Action	Note/Illustration
2	Refit the joystick protection.	 <p>xx1800001200</p>
3	Secure the screws.	 <p>xx1800001206</p> <p>Countersunk head screw: ST2.9 X 10 (6 pcs)</p>

5 Repair

5.4.3 Replacing the fasten strip

5.4.3 Replacing the fasten strip

Location

The illustration shows the location of the fasten strip on the FlexPendant.

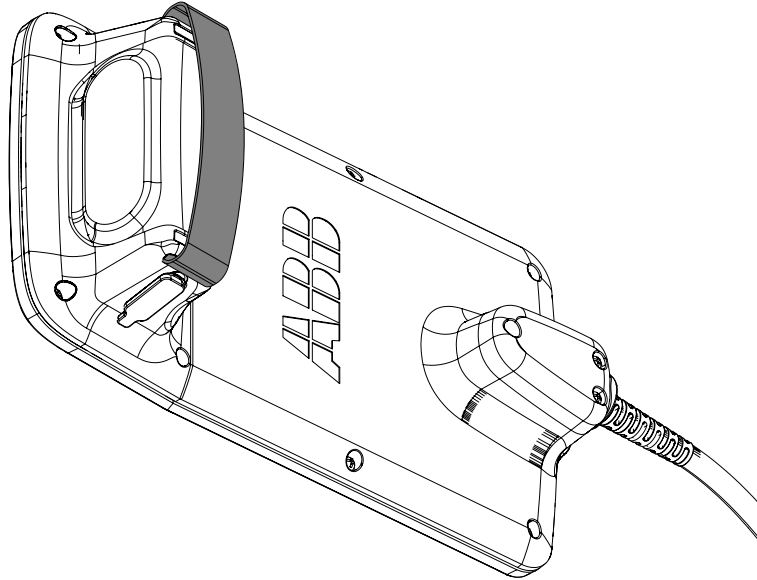

xx1900000771

Required spare parts



Note

The spare part numbers that are listed in the table can be out of date. See the latest spare parts of the OmniCore C90XT via myABB Business Portal, www.abb.com/myABB.

Spare part	Article number	Note
Fasten strip	3HAC065419-001	

Replacing the fasten strip

	Action	Note/Illustration
1	Open the velcro on the fasten strip.	
2	Take the fasten strip out from the holes.	
3	Insert the new fasten strip into the holes one by one.	
4	Secure the velcro in a suitable length.	

6 Decommissioning

6.1 Introduction to decommissioning

Introduction

This section contains information to consider when taking a product, robot or controller, out of operation.

It deals with how to handle potentially dangerous components and potentially hazardous materials.



Note

The decommissioning process shall be preceded by a risk assessment.

Disposal of materials used in the robot

All used grease/oils and dead batteries **must** be disposed of in accordance with the current legislation of the country in which the robot and the control unit are installed.

If the robot or the control unit is partially or completely disposed of, the various parts **must** be grouped together according to their nature (which is all iron together and all plastic together), and disposed of accordingly. These parts **must** also be disposed of in accordance with the current legislation of the country in which the robot and control unit are installed.

See also [Environmental information on page 380](#).

Disposal of storage media

Before disposal of any storage equipment (anything from an SD card to a complete controller), make sure that all sensitive information has been deleted.



Tip

To remove all data from the OmniCore controller, use the **Delete user data** function (part of **Delete RobotWare system** function) in RobotWare. See *Operating manual - Integrator's guide OmniCore*.

Transportation

Prepare the robot or parts before transport, this to avoid hazards.

6 Decommissioning

6.2 Environmental information

6.2 Environmental information

Introduction

ABB robots contain components in different materials. During decommissioning, all materials should be dismantled, recycled, or reused responsibly, according to the relevant laws and industrial standards. Robots or parts that can be reused or upcycled helps to reduce the usage of natural resources.

Symbol

The following symbol indicates that the product must not be disposed of as common garbage. Handle each product according to local regulations for the respective content (see table below).

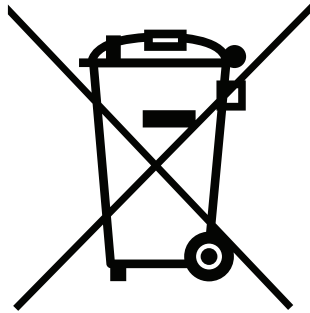

xx1800000058

Materials used in the product

The table specifies some of the materials in the product and their respective use throughout the product.

Dispose components properly according to local regulations to prevent health or environmental hazards.

Material	Example application
Aluminium	Heat sinks on power supplies and drive units
Batteries, Lithium	Main computer
Brominated flame retardants	Electronics
Copper	Cables
Lead	Electronics
Plastic/rubber	Cables, connectors, etc.
Silicone	Power supply ⁱ
Steel	Cabinet structure, plates, screws, etc.

ⁱ The product does not contain silicone by design but there might be a minimal risk of contamination during production.

Continues on next page

China RoHS symbol

The following symbol shows the information to hazardous substances and the environmental protection use period of OmniCore C90XT according to "Management Methods for the Restriction of the Use of Hazardous Substances in Electrical and Electronic Products (SJ/T 11364-2014)".



xx190000804

Orange symbol with a number in it: The product contains certain hazardous substances and can be used safely during its environmental protection use period (as indicated by the number in the center) which should enter into the recycling system after its environmental protection use period.



Note

This form and environmental protection use period label are based on the regulation in China. These are not necessary to be concerned in other countries.

This page is intentionally left blank

7 Troubleshooting

7.1 Introduction to troubleshooting

Introduction

The product manual and the circuit diagram contains information that can be good when troubleshooting.

For OmniCore, all event logs from the software can be seen on the FlexPendant, or in *Technical reference manual - Event logs for RobotWare 7*.

Make sure to read through the section [Safety on page 15](#) before starting.

Troubleshooting strategies

- 1 Isolate the fault to pinpoint the cause of the problem from consequential problems.
- 2 Divide the fault chain in two.
- 3 Check communication parameters and cables.
- 4 Check that the software version is compatible with the hardware.

Work systematically

- 1 Take a look around to make sure that all screws, connectors, and cables are secured, and that the robot and other parts are clean, not damaged, and correctly fitted.
- 2 Replace one thing at a time.
- 3 Do not replace units randomly.
- 4 Make sure that there are no loose screws, turnings, or other unexpected parts remaining after work has been performed.
- 5 When the work is completed, verify that the safety functions are working as intended.

Keep a track of history

- Make a historical fault log to keep track of problems over time.
- Consult those working with the robot when the problem occurred.

Basic scenarios

What to look for during troubleshooting depends on when the fault occurred. Was the robot recently installed or was it recently repaired? The following table gives hints on what to look for in specific situations.

The robot has recently been installed	Check: <ul style="list-style-type: none"> • the configuration files • connectors • options and their configuration • changes in the robot working space/movements.
---------------------------------------	--

Continues on next page

7 Troubleshooting

7.1 Introduction to troubleshooting

Continued

The robot has recently been repaired	Check: <ul style="list-style-type: none">• all connections to the replaced part• power supplies• that the correct part has been fitted• the last repair documents.
The robot recently had a software upgrade	Check: <ul style="list-style-type: none">• software versions• compatibilities between hardware and software• options and their configuration
The robot has recently been moved from one site to another (an already working robot)	Check: <ul style="list-style-type: none">• connections• software versions

7.2 Troubleshooting fault symptoms

Fault symptoms described in this manual

This manual describes how to troubleshoot the following fault symptoms:

- *No LEDs are lit on the controller on page 386*
- *Start-up failure on page 389*
- *Problem releasing the robot brakes on page 393*
- *Problem starting or connecting the FlexPendant on page 397*
- *Problem using the joystick on page 401*
- *Controller fails to start on page 402*
- *Reflashing firmware failure on page 403*
- *Inconsistent path accuracy on page 404*
- *Controller is overheated on page 406*

Continues on next page

7 Troubleshooting

7.2.1 No LEDs are lit on the controller

7.2.1 No LEDs are lit on the controller

Description

No LEDs at all are lit in the controller.

Required test equipment

Equipment needed for troubleshooting:

Equipment	Note
Multimeter	
Insulating gloves	

Preparations

	Action
1	Make sure that the controller is switched on. Wait 30 s - 1 min to enable start-up sequence.
2	Check the FlexPendant for errors and warnings.
	 DANGER Troubleshooting on the controller while powered on must be performed by personnel trained by ABB or by ABB field engineers.

Recommended working procedure

If no LEDs are lit on the controller during start-up, use this procedure to troubleshoot what might cause the problem.

Look at the following block diagram to understand how power is connected from incoming and forward.

Block diagram

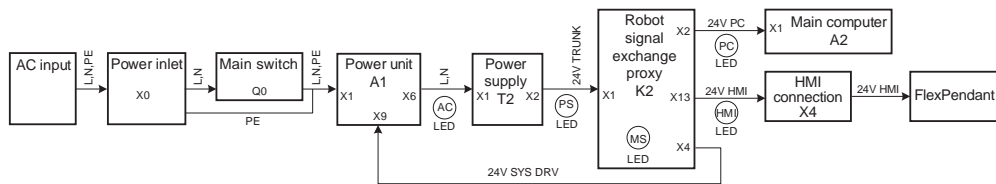

xx200000443

Continues on next page

Troubleshooting flowchart

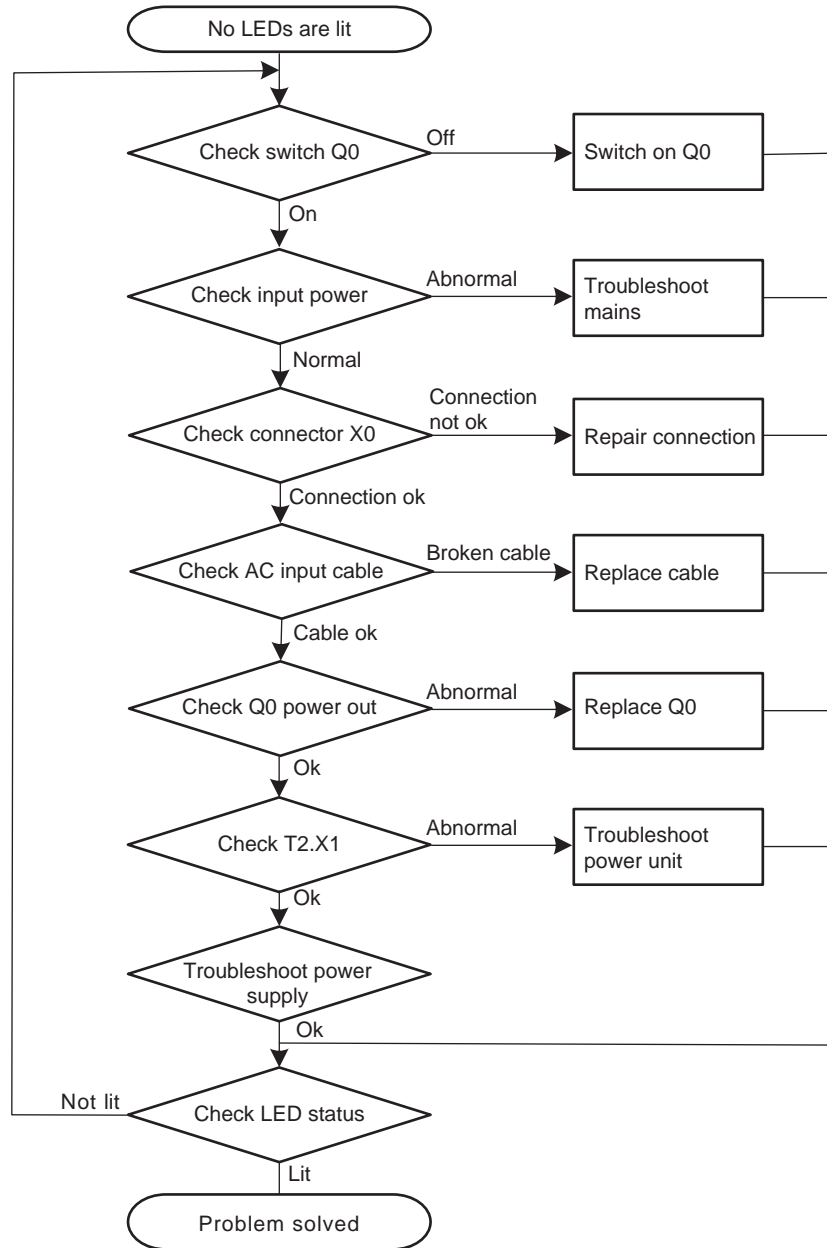



xx200000444

7 Troubleshooting

7.2.1 No LEDs are lit on the controller

Continued

Detailed working procedure

	Action	Note
1	Make sure that the power inlet switch (Q0) has been switched on.	 <p>xx2000000445</p>
2	Make sure that the system is supplied with power. <ul style="list-style-type: none"> • Make sure that the RCD and circuit breaker/fuse (if used) are closed. • Measure incoming mains voltage and make sure the voltage is within the normal range. 	Use a multimeter and insulating gloves. If incoming mains is not ok, the problem is not in the robot controller. Troubleshoot incoming mains.
3	Check that the mains connection (X0) is properly connected.  Tip For more details, see <i>Circuit diagram - OmniCore C90XT</i> .	
4	Check that the AC input cable is properly connected.	
5	Check the output voltage of (Q0). <ul style="list-style-type: none"> • Make sure that (Q0) is closed. 	Use a multimeter and insulating gloves. Replace if damaged, see Replacing the incoming mains connector on page 330 .
6	Confirm that the controller is for CRB 15000 or not.	<ul style="list-style-type: none"> • If the controller is for CRB 15000, troubleshoot the power unit. See Troubleshooting the power unit on page 411. • If the controller is not for CRB 15000, proceed with next step.
7	Check connector T2.X1.	<ul style="list-style-type: none"> • If abnormal, troubleshoot the power unit. See Troubleshooting the power unit on page 411. • If normal, troubleshoot the power supply unit. See Troubleshooting the power supply on page 430.

7.2.2 Start-up failure

Description

The following are possible symptoms of a start-up failure:

- 1 The LEDs are not lit on some units.
- 2 Unable to load the system software.

Required test equipment

Equipment needed for troubleshooting:

Equipment	Note
Multimeter	
Insulating gloves	
Circuit diagram - OmniCore C90XT	3HAC065464-009

Preparations

Action	
1	Make sure that the controller is switched on. Wait 30 s - 1 min to enable start-up sequence.
2	Check the FlexPendant for errors and warnings.
	 DANGER Troubleshooting on the controller while powered on must be performed by personnel trained by ABB or by ABB field engineers.

Recommended working procedure

If there seems to be a power failure during start-up, use this procedure to troubleshoot what might cause the problem.

Block diagram

Look at the following block diagram to understand how power is connected from incoming and forward.

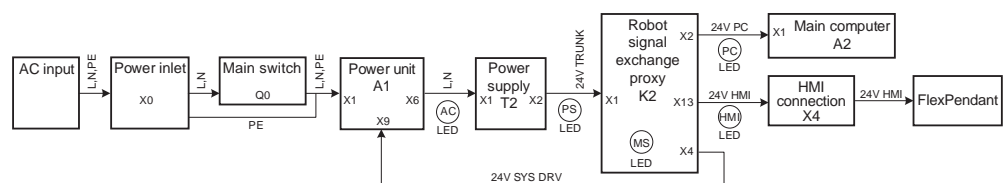

xx2000000443

Continues on next page

7 Troubleshooting

7.2.2 Start-up failure

Continued

Troubleshooting flowchart

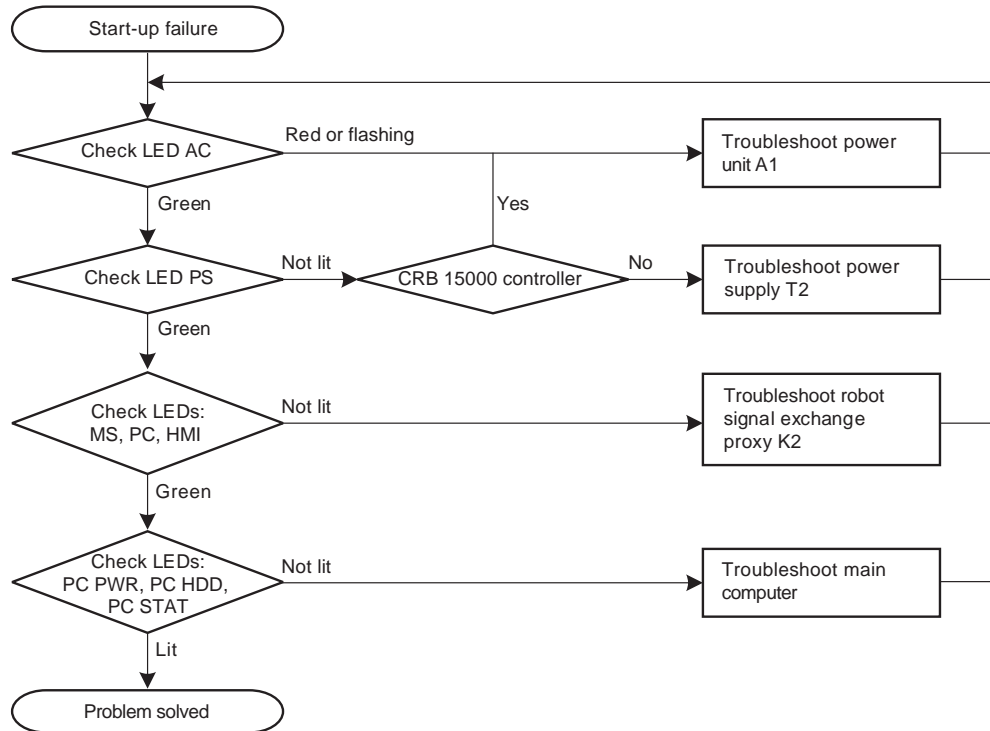

xx1800001829

Location of LEDs

LEDs on the robot signal exchange proxy:

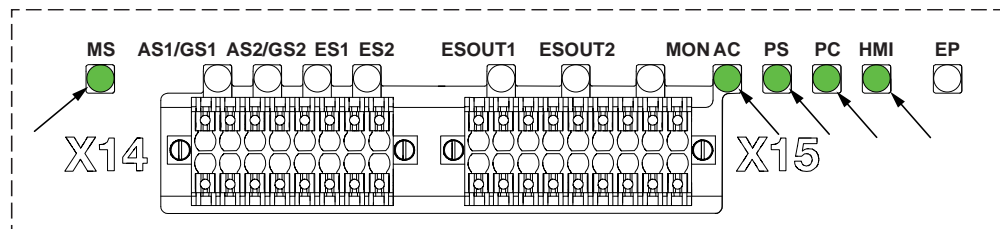

xx2100001067

LEDs on the main computer:

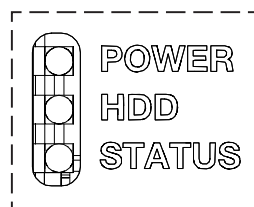

xx2100001068

Continues on next page

Detailed working procedure

	Action	Note
1	Look at the LED AC.	LED AC should be green. <ul style="list-style-type: none"> If not, see Troubleshooting the power unit on page 411. If the power unit is ok, check that incoming mains is well connected and that the incoming mains switch is turned on.
2	Look at the LED PS.	LED PS should be green. <ul style="list-style-type: none"> If not, see Troubleshooting the power supply on page 430. If the power supply is ok, see Troubleshooting the power unit on page 411. If the power unit is ok, check that the power inlet is properly connected and the power inlet switch is turned on. <p>For more details about the LEDs, see Troubleshooting the robot signal exchange proxy on page 438.</p>
3	Look at the LED MS.	LED MS should be green. <ul style="list-style-type: none"> If not, see Troubleshooting the robot signal exchange proxy on page 438.
4	Look at the LEDs PC and HMI.	LED PC and LED HMI should be green. <ul style="list-style-type: none"> If not, see Troubleshooting the robot signal exchange proxy on page 438
5	Look at the LEDs PC PWR, PC HDD, and PC STAT.	For more details about the LEDs, see Troubleshooting the main computer on page 427 .
6	If the problem remains, contact ABB.	

**Tip**

For more details, see *Circuit diagram - OmniCore C90XT*.

7 Troubleshooting

7.2.3 System update failure

7.2.3 System update failure

Description

In certain scenarios, such as removing or adding certain optional features or major upgrades of installed software products versions, the previous backup may be incompatible with the newly re-configured system. Automatically reloading backup can therefore fail, resulting in system failure state after the update.

For more information about system update, see *Operating manual - Integrator's guide OmniCore*.

Recommended working procedure

To remove system failure resulting from system updates, there are two main strategies:

- A Go forward with the new system configuration and correct the errors, see [New system configuration on page 392](#).
- B Rollback all changes in the system and bring the system to the same state as it was before the update, see [Rollback all changes in the system on page 392](#).

New system configuration

- 1 Reset the RobotWare system.
The RAPID program and system parameters will be removed, and the system will be set to default state, but without system failure.
- 2 Re-implement your programs or configuration changes, or
- 3 Selectively load contents from the previous system backup and correct possible errors when loading.

Rollback all changes in the system

The previous system state can be restored through the RobotWare Installation Utilities in one of the following ways:

- 1 Restore all installed software, user and system internal data with a selected snapshot (backup copy) of the previous system state. This is the simplest way.
- 2 Perform a complete re-installation of the RobotWare system using RobotWare Installation Utilities, start the RobotWare system and then reload the previous backup.

7.2.4 Problem releasing the robot brakes

Description

When starting robot operation or jogging the robot, the internal robot brakes must release in order to allow movement.

Required test equipment

Equipment needed for troubleshooting:

Equipment	Note
Multimeter	
Insulating gloves	
Circuit diagram - OmniCore C90XT	3HAC065464-009

Preparations

	Action
1	Make sure that the controller is switched on. Wait 30 s - 1 min to enable start-up sequence.
2	Check the FlexPendant for errors and warnings.
	 DANGER Troubleshooting on the controller while powered on must be performed by personnel trained by ABB or by ABB field engineers.

Recommended working procedure

If the brakes do not release, no robot movement is possible and a number of error log messages can occur. Use this procedure to troubleshoot what might cause the problem.

Look at the following block diagram to understand how power is connected from incoming and forward.

Block diagram

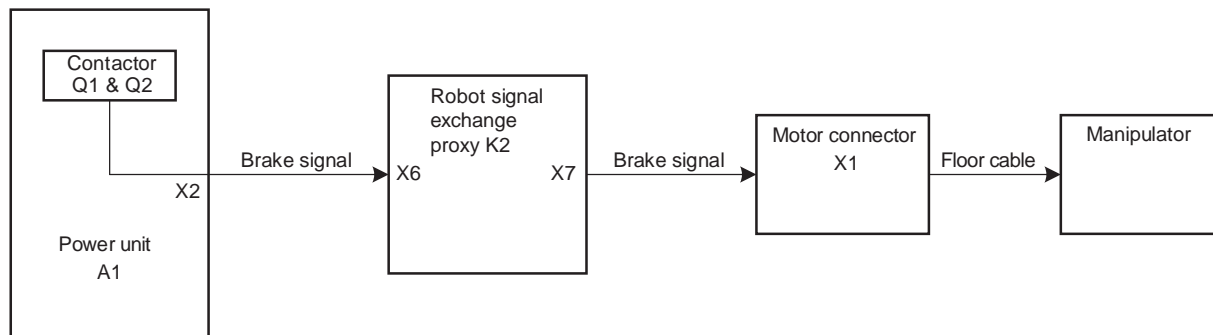

xx1800001835

Continues on next page

7 Troubleshooting

7.2.4 Problem releasing the robot brakes

Continued

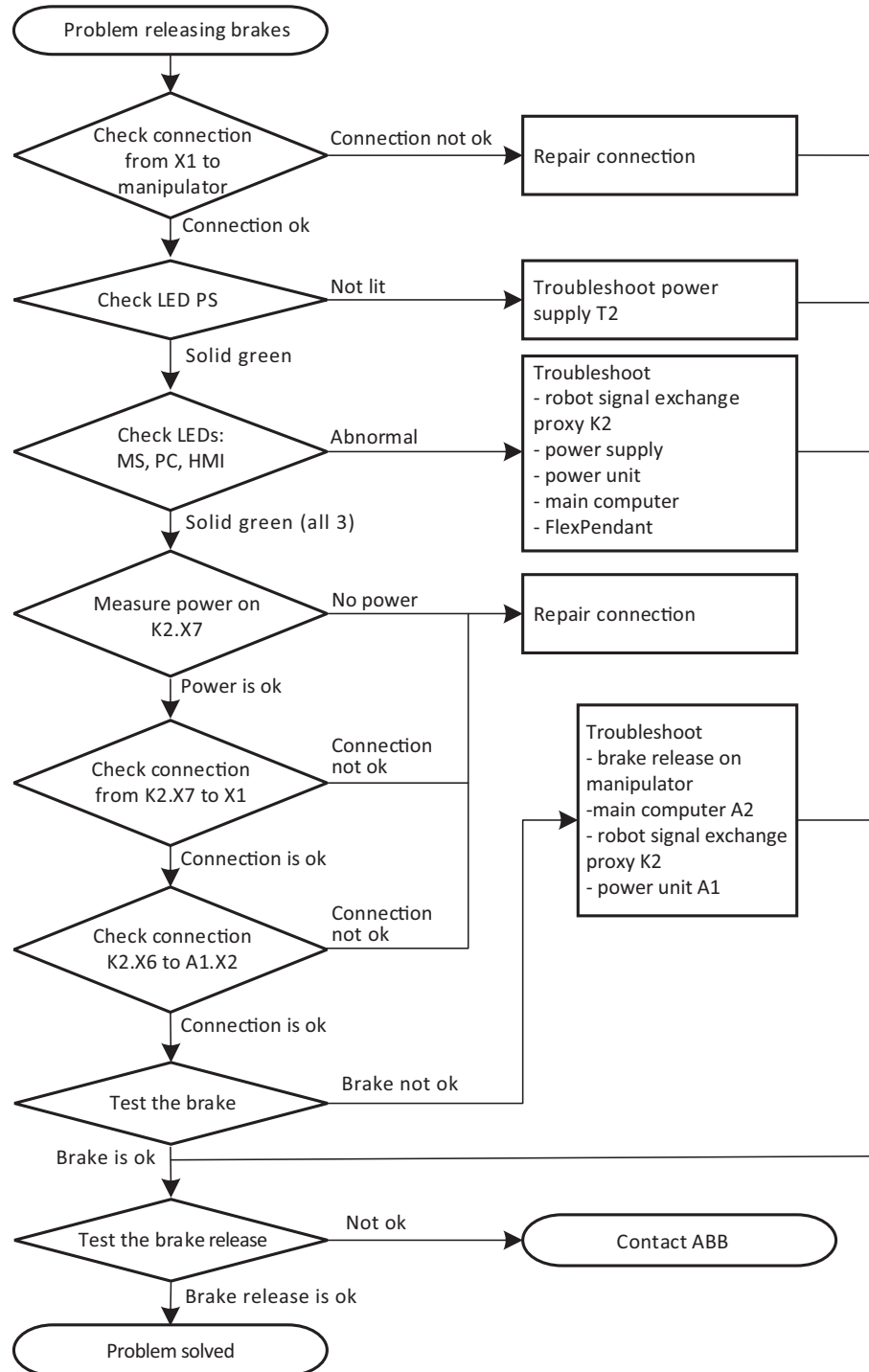

Troubleshooting flowchart



xx1800001836

Continues on next page

Detailed working procedure

	Action	Note
1	<p>Check that the floor cable is connected from the manipulator to the motor connector X1.</p> <p>Visually inspect the cable for damage or extensive bending marks.</p> <p> Tip</p> <p>For more details, see <i>Circuit diagram - OmniCore C90XT</i>.</p>	<ul style="list-style-type: none"> • If the cable is damaged, replace to a new cable and go to step 8. • If the cable is not connected, repair the connection and go to step 8. • If the cable is ok, go to the next step.
2	<p>Look at the LED PS on the front of the robot signal exchange proxy. LED PS should be solid green.</p>	<p>For more details about the LEDs, see Troubleshooting the robot signal exchange proxy on page 438.</p> <ul style="list-style-type: none"> • If it is not green, see Troubleshooting the power supply on page 430.
3	<p>Look at the LED MS, LED PC and LED HMI. All LEDs should be solid green.</p>	<ul style="list-style-type: none"> • If LED MS is not green, see Troubleshooting the robot signal exchange proxy on page 438. • If LED PC or LED HMI are not green, see Troubleshooting the power supply on page 430. • If the power supply is ok, see Troubleshooting the power unit on page 411. • If the power unit is ok, check that incoming mains is connected and that the incoming mains switch is turned on. • If the LED PC is green, but LED PC_PWR on the main computer is not green, see Troubleshooting the main computer on page 427. • If the LED HMI is green, but the FlexPendant is not starting, see Troubleshooting the FlexPendant on page 408.
4	<p>Measure the power on K2.X7.</p> <p> Tip</p> <p>For more details, see <i>Circuit diagram - OmniCore C90XT</i>.</p>	<p>Use a multimeter and insulating gloves.</p> <ul style="list-style-type: none"> • If there is no power, repair the connection and go to step 8. • If it is ok, go to the next step.
5	<p>Check that the connection from the robot signal exchange proxy to the motor connector is ok:</p> <ul style="list-style-type: none"> • K2.X7 - X1. 	<ul style="list-style-type: none"> • If it is not, repair the connection and go to step 8. • If it is ok, go to the next step.

Continues on next page

7 Troubleshooting

7.2.4 Problem releasing the robot brakes

Continued

	Action	Note
6	Check that the connection from main computer to the robot signal exchange proxy is ok: <ul style="list-style-type: none">• K2.X6 - A1.X2	<ul style="list-style-type: none">• If it is not, repair the connection and go to step 8.• If it is ok, go to the next step.
7	Try jogging the robot.	<ul style="list-style-type: none">• If it is not working properly, the brake release board on the manipulator might be broken. Contact your local ABB for more information.• If the brakes work normally, troubleshoot the main computer, the robot signal exchange proxy, and the power unit, one by one. If needed, replace faulty units. Go to step 8.
8	Check that the brake release function is ok.	For more details on how to release the brakes, see the robot's product manual. <ul style="list-style-type: none">• If it is not ok, contact your local ABB.

7.2.5 Problem starting or connecting the FlexPendant

Description

The FlexPendant is not responding, either completely or intermittently. No entries are possible, and no functions are available.



Note

If protective gloves are used, these must be compatible with touchscreens when using the FlexPendant.

The FlexPendant starts but does not display the main interface.

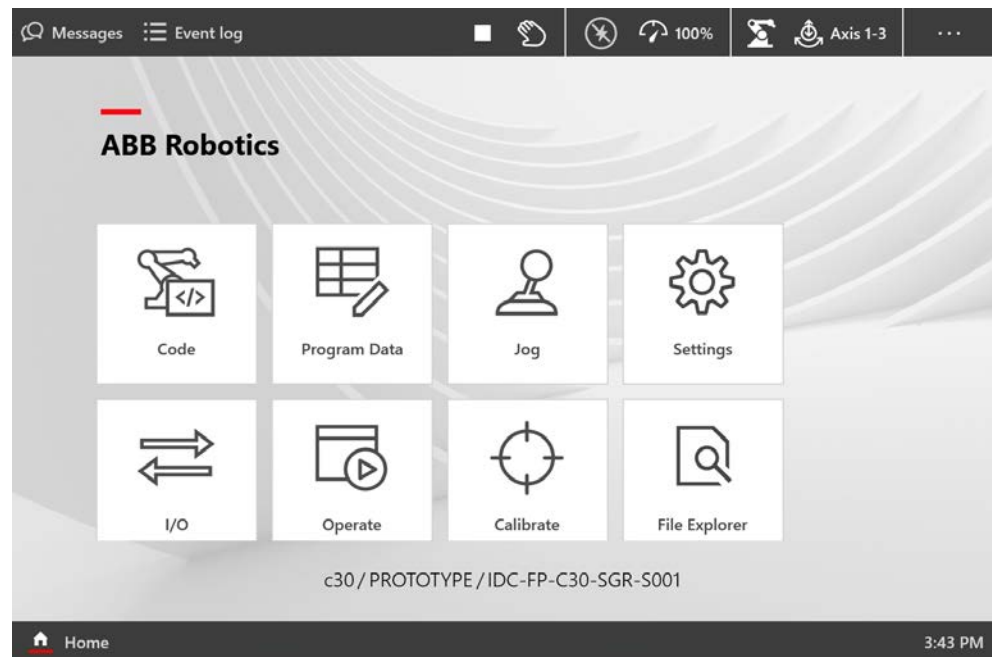

xx1900000917

Required test equipment

Equipment needed for troubleshooting:

Equipment	Note
Multimeter	
Insulating gloves	
Circuit diagram - OmniCore C90XT	3HAC065464-009

Preparations

	Action
1	Make sure that the controller is switched on. Wait 30 s - 1 min to enable start-up sequence.
2	Check the FlexPendant for errors and warnings.

Continues on next page

7 Troubleshooting

7.2.5 Problem starting or connecting the FlexPendant

Continued

Action	
	<p>DANGER</p> <p>Troubleshooting on the controller while powered on must be performed by personnel trained by ABB or by ABB field engineers.</p>

Recommended working procedure

If the FlexPendant starts but does not display the main interface during the start-up, use this procedure to troubleshoot what might cause the problem.

Look at the following block diagram to understand how power is connected from incoming and forward.

Block diagram

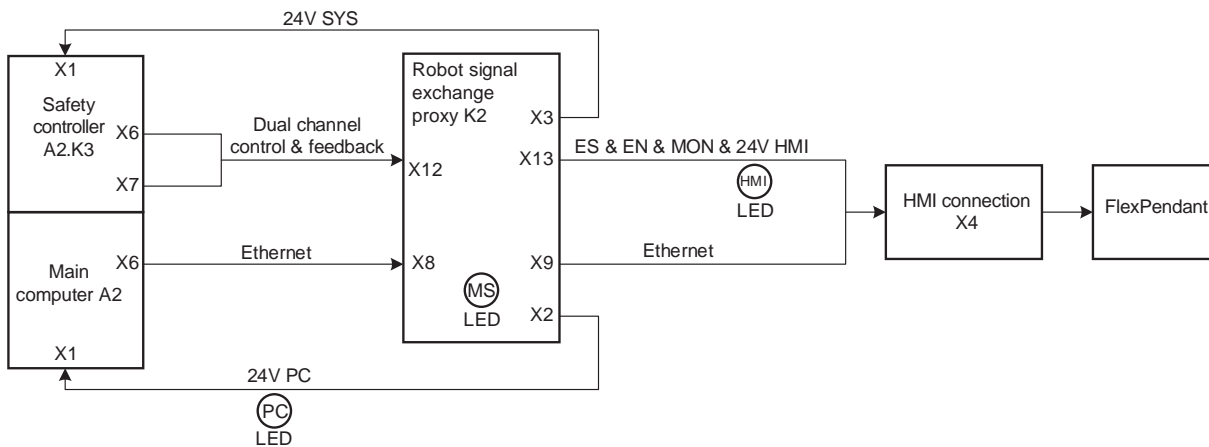

xx1800001830

Continues on next page

Troubleshooting flowchart

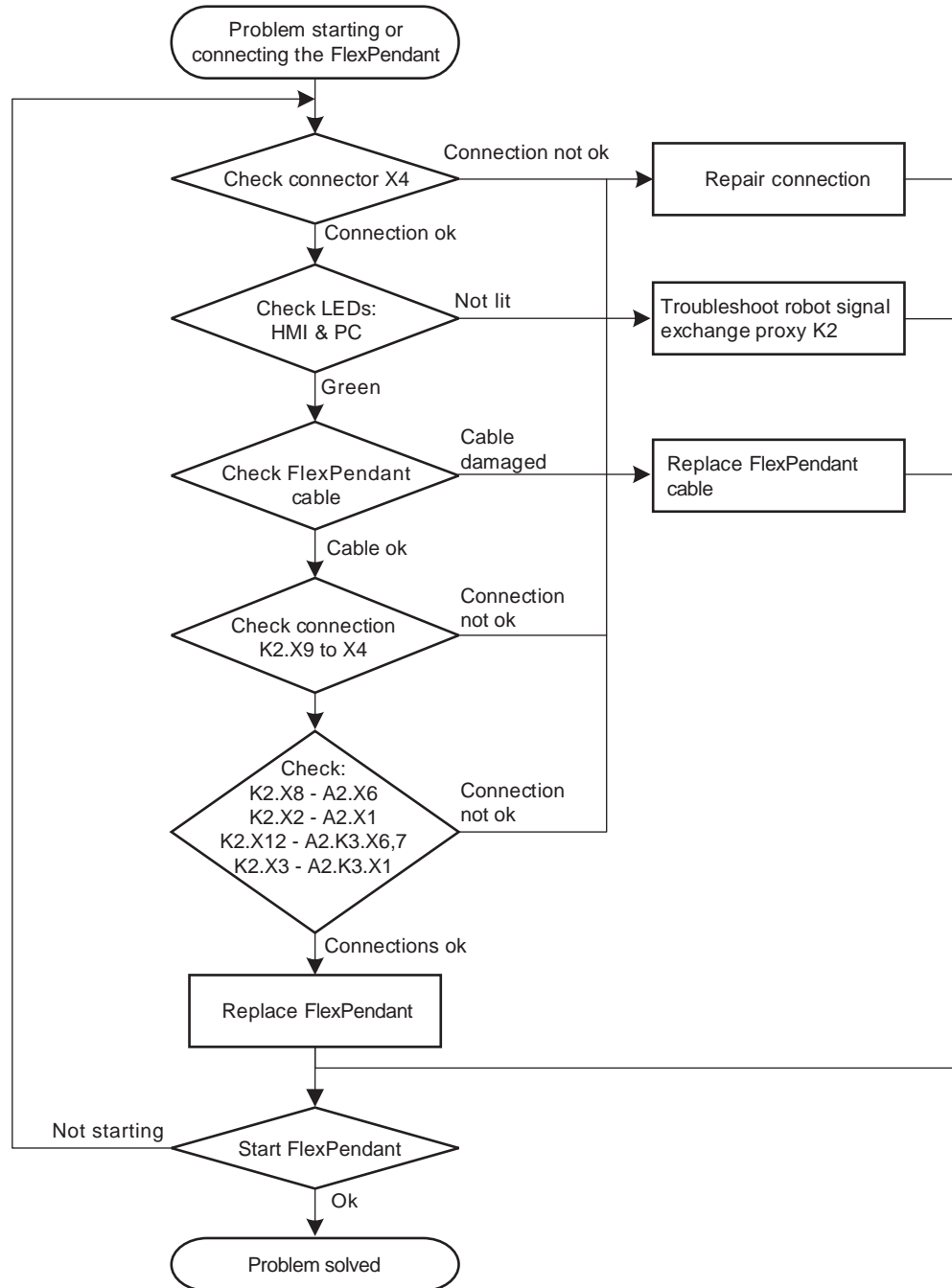

xx1800001831

Detailed working procedure

	Action	Note
1	Try resetting the FlexPendant using the reset button located next to the USB port.	See <i>Operating manual - OmniCore</i> .

Continues on next page

7 Troubleshooting

7.2.5 Problem starting or connecting the FlexPendant

Continued

	Action	Note
2	Check that the FlexPendant cable is correctly connected to the controller through the HMI signal connector, X4.	If it is not connected, repair the connection and go to step six. Check the pins in the connector. If it is ok, go to the next step.
3	Check the LED PC and LED HMI, they should be green.	For more details about the LEDs, see Troubleshooting the robot signal exchange proxy on page 438 . <ul style="list-style-type: none"> If the LEDs are not green, see Troubleshooting the robot signal exchange proxy on page 438. If they are ok, go to the next step.
4	Check the FlexPendant cable for any damage.	<ul style="list-style-type: none"> If damage is found, replace the FlexPendant cable and go to step six. If it is ok, go to the next step.
5	Check that the connection from the robot signal exchange proxy to the HMI signal connector is ok, K2.X9, 13 - X4.	<ul style="list-style-type: none"> If it is not ok, repair the connection and go to step six. If it is ok, go to the next step.
6	Check that the connection from the robot signal exchange proxy to the main computer is ok: <ul style="list-style-type: none"> K2.X8 - A2.X6 K2.X2 - A2.X1 K2.X12 - A2.K3.X6,7 K2.X3 - A2.K3.X1 	<ul style="list-style-type: none"> If any connection fails, repair the connection and go to step six. If the connections are ok, go to the next step.
7	If possible, test by connecting another FlexPendant. This is to eliminate the FlexPendant and cable as error sources; Test the FlexPendant with a different controller to eliminate the controller as error source.	
8	Check that the FlexPendant works normally.  Tip This is detailed in section Troubleshooting the FlexPendant on page 408 .	If it is not ok, contact your local ABB.

7.2.6 Problem using the joystick

Description

The FlexPendant is started and responds when you push the buttons or tap on the touchscreen. However, the joystick does not work and no warnings or messages show up. It is therefore not possible to jog the robot.

Recommended working procedure

	Action	Information
1	Make sure that the joystick lock is not activated.	See <i>Operating manual - OmniCore</i> .
2	Make sure the controller is in manual mode.	
3	Make sure the FlexPendant is connected correctly to the controller.	
4	Press the reset button located next to the USB port on the back of the FlexPendant.  Note The reset button only resets the FlexPendant, not the system on the controller.	If the joystick is still not working, then replace the FlexPendant.

7 Troubleshooting

7.2.7 Controller fails to start

7.2.7 Controller fails to start

Description

If the controller fails to start, the FlexPendant is not operational.

Function description

The robot controller always runs in one of the following two modes:

- Normal operation mode (a user-created system is selected to run)
- RobotWare Installation Utilities mode (advanced maintenance mode)

In rare occasions, a serious error (in the software or the configuration of the installed system), may prevent the controller from starting properly in the normal operation mode. A typical case is when a controller is restarted after a network configuration change, causing the controller to be non-responsive from FlexPendant, RobotStudio, or FTP. To restore the robot controller from this situation, the controller can be forced to start in RobotWare Installation Utilities mode.

Forcing startup of the RobotWare Installation Utilities mode

Repeat the following action two times in a row:

- 1 Turn on the main power switch.
- 2 Wait for approximately 15 seconds.



Note

The PC STAT LED should be in flashing red state.

- 3 Turn off the main power switch.

In the next startup (third time), the installed system is de-selected and the RobotWare Installation Utilities mode is started.

This has no effect if the controller is already in RobotWare Installation Utilities mode.



Note

Force starting the RobotWare Installation Utilities mode will not affect the files in the directories belonging to the installed system.

See also [Troubleshooting the main computer on page 427](#).

How to install systems is described in *Operating manual - Integrator's guide OmniCore*.

7.2.8 Reflashing firmware failure

Description

When reflashing firmware, the automatic process can fail which will stop the system. A message is generated in the event log.

This fault usually occurs due to a lack of compatibility between hardware and software.

Recommended working procedure

If the controller stops with a message about firmware failure, use this procedure to troubleshoot what might cause the problem.

	Action	Note
1	Read the message to see which unit has failed.	
2	If the relevant unit has been replaced recently, make sure that the versions of the old and the new unit are identical.	
3	Check the software versions.	
4	If RobotWare has been updated recently, make sure that the versions of the old and the new unit are identical.	
5	If the problem remains, contact your local ABB for information about which firmware version is compatible with your hardware.	

7 Troubleshooting

7.2.9 Inconsistent path accuracy

7.2.9 Inconsistent path accuracy

Description

The path of the robot TCP is not consistent. It varies from time to time, and is sometimes accompanied by noise emerging from bearings, gearboxes, or other locations.

Possible causes

The symptom can be caused by (the causes are listed in order of probability):

- Robot not calibrated correctly.
- Robot TCP not correctly defined.
- Parallel bar damaged (applies to robots fitted with parallel bars only).
- Mechanical joint between motor and gearbox damaged. This often causes noise to be emitted from the faulty motor.
- Bearings damaged or worn (especially if the path inconsistency is coupled with clicking or grinding noises from one or more bearings).
- The wrong robot type may be connected to the controller.
- The brakes may not be releasing correctly.

Recommended working procedure

The path accuracy depends on many factors. The following table describes the most common causes of problems with the path accuracy. Depending on your installation, the recommended working procedure is to work step by step, starting with the step that seems most plausible given your circumstances.

	Action	Note
1	Study the path of the robot in motion, to find if an external force, for example, an external cable package, is colliding with or restricting the movement of the robot.	Remove the obstacles.
2	In high temperature environments, the material in the robot can expand, thereby causing inconsistent path accuracy.	Improve the ventilation around the robot.
3	Make sure the robot tool and work object are correctly defined.	How to define these are described in <i>Operating manual - OmniCore</i> .
4	Check the positions of the revolution counters.	Update if required.
5	If required, re-calibrate the robot axes.	How to calibrate the robot is described in the product manual for the robot.
6	If you hear noise that has not been there before, locate the source to define if a motor or bearing is faulty. Study the path of the robot TCP to establish which axis, and thus which motor, may be faulty.	Replace the faulty motor, gearbox, or bearing as specified in the product manual for the robot.
7	Check the trueness of the parallel bar (applies to robots fitted with parallel bars only).	Replace the faulty parallel bar as specified in the product manual for the robot.

Continues on next page

	Action	Note
8	Make sure the correct robot type is connected as specified in the system.	Update the system with the correct robot type, see <i>Operating manual - Integrator's guide OmniCore</i> .
9	Make sure the robot brakes work properly.	Proceed as detailed in section Problem releasing the robot brakes on page 393 .
10	If applicable: Check the setting for the swivel.	The swivel has an in-built resistance that needs to be set in the system parameters.

7 Troubleshooting

7.2.10 Controller is overheated

7.2.10 Controller is overheated

Required test equipment

Equipment needed for troubleshooting:

Equipment	Note
Multimeter	
Insulating gloves	
Circuit diagram - OmniCore C90XT	3HAC065464-009

Preparations

	Action
1	Make sure that the controller is switched on. Wait 30 s - 1 min to enable start-up sequence.
2	Check the FlexPendant for errors and warnings.
	 DANGER Troubleshooting on the controller while powered on must be performed by personnel trained by ABB or by ABB field engineers.

Recommended working procedure

If the controller seems to be overheated, use this procedure to troubleshoot what might cause the problem.

Detailed working procedure

	Action	Note
1	Check that the standard fans are working.	Replace malfunctioning fans, see Replacing the standard fan on page 197
2	Inspect the air filters to make sure they are clean.	If air filters are not clean, see Cleaning air filter on page 170 If air filters need to be replaced, see Replacing the air filter on page 311 .
3	If the problem remains, troubleshoot the power unit and/or the drive unit.	See Troubleshooting the power unit on page 411 and Troubleshooting the drive unit on page 409 .

7.3 Troubleshooting units

7.3.1 Troubleshooting LEDs in the controller

Description

The controller features a number of indication LEDs, which provide important information for troubleshooting purposes. If no LEDs light up at all when switching the system on, troubleshoot as detailed in this section.

All LEDs on the respective units, and their significance, are described in the following sections.

Units with LEDs in the controller

Drive unit	Troubleshooting the drive unit on page 409
Power unit	Troubleshooting the power unit on page 411
Scalable I/O	Troubleshooting fieldbuses and I/O on page 416
3G Connected Services gateway	Troubleshooting the 3G Connected Services gateway on page 417
Ethernet switch	Troubleshooting the Ethernet switch (DSQC1035) on page 423
Axis computer	Troubleshooting the axis computer on page 425
Main computer	Troubleshooting the main computer on page 427
Power supply	Troubleshooting the power supply on page 430
Fieldbus adapter slave	Troubleshooting the fieldbus adapter slave on page 436
Robot signal exchange proxy	Troubleshooting the robot signal exchange proxy on page 438

7 Troubleshooting

7.3.2 Troubleshooting the FlexPendant

7.3.2 Troubleshooting the FlexPendant

Description

The FlexPendant communicates with the main computer. The FlexPendant is physically connected to the panel board. The cable contains the +24 V supply, two enabling device chains and emergency stop.

Procedure

The procedure below describes what to do if the FlexPendant does not work correctly.

	Action	Note
1	Try resetting the FlexPendant using the reset button located next to the USB port.	See <i>Operating manual - OmniCore</i> .
2	If the FlexPendant is not responding or does not operate correctly, see Problem starting or connecting the FlexPendant on page 397 .	 Note If protective gloves are used, these must be compatible with touchscreens when using the FlexPendant.
3	Check the cable for connections and integrity.	
4	Check the 24 V power supply.	
5	Read the error event log message and follow any instructions of references.	

For more information on the FlexPendant, see *Operating manual - OmniCore*.

7.3.3 Troubleshooting the drive unit

Location

The illustration shows the location of the drive unit in the controller.

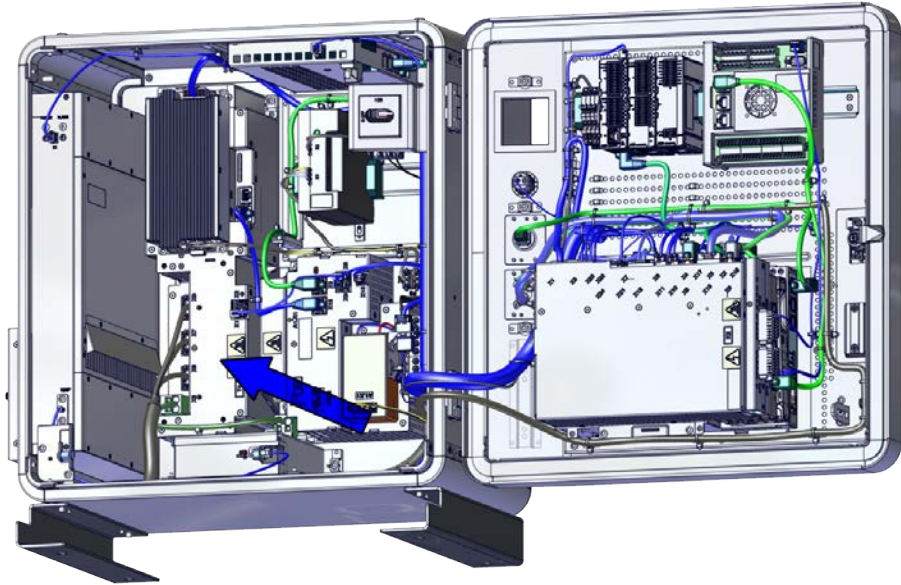

xx1900001471

LEDs

The illustration below shows the indication LEDs on the drive unit.

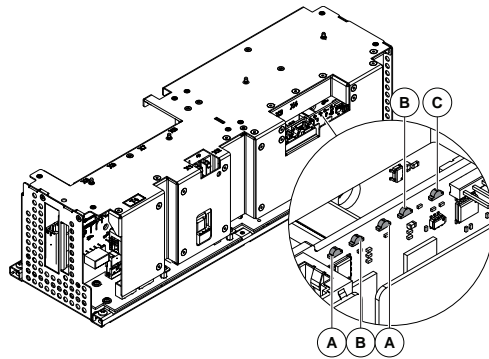

xx1800000575

A	Ethernet LEDs (yellow)
B	Ethernet LEDs (green)
C	Status LED

Continues on next page

7 Troubleshooting

7.3.3 Troubleshooting the drive unit

Continued

Description	Significance
Ethernet LEDs	<p>Shows the status of Ethernet communication between the drive unit and the power unit.</p> <p>Green:</p> <ul style="list-style-type: none">• Off: 10 Mbps data rate is selected.• On: 100 Mbps data rate is selected. <p>Yellow:</p> <ul style="list-style-type: none">• Flashing: The two units are communicating on the Ethernet channel.• Steady: A LAN link is established.• Off: A LAN link is <i>not</i> established.
Drive unit status LED	<p>The status indicator LED can be used to identify the following status during startup/power on:</p> <ol style="list-style-type: none">1 Red, steady: Default when power is available.2 Red, flashing: Power is on, self-test is ongoing, operating system is loading.3 Green, flashing: Application is loaded and waiting for communication.4 Green, steady: Drive unit is operational. <p>If the LED does not turn steady green after 30-60 sec, the status indicator LED can be used to identify the following issues:</p> <ul style="list-style-type: none">• No color: Power to the drive unit is missing.• Red, steady: Internal error.• Red, flashing: Firmware error or self-test failure.• Green, flashing: Communication error to another module.

7.3.4 Troubleshooting the power unit

Location

The illustration below shows the location of the power unit in the controller.

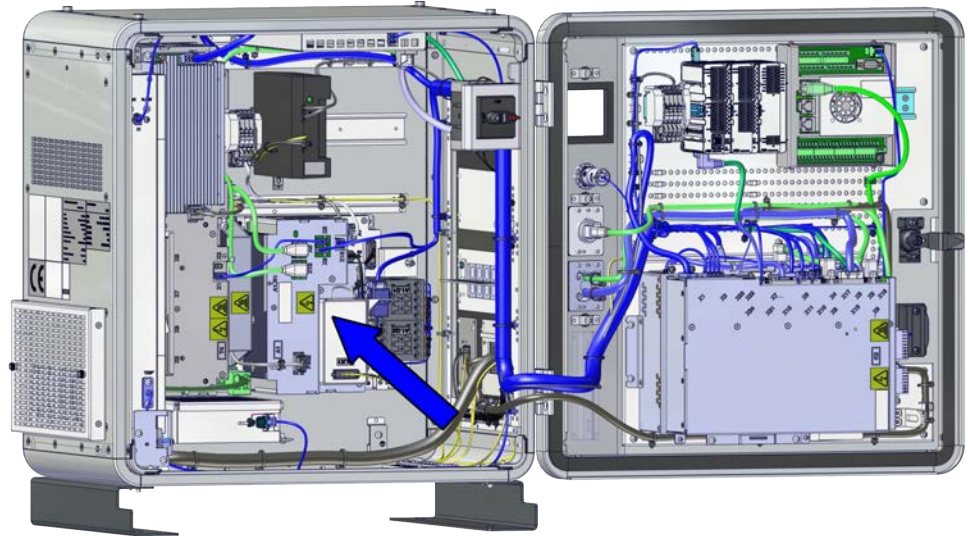

xx1900001469

LEDs

The illustration below shows the LEDs on the power unit.

OmniCore C90XT

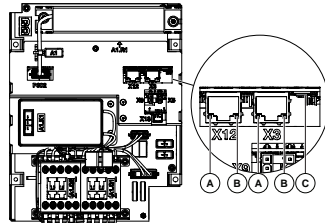

xx1800000576

A	Ethernet LEDs (yellow)
B	Ethernet LEDs (green)
C	Status LED

Continues on next page

7 Troubleshooting

7.3.4 Troubleshooting the power unit

Continued

Description	
Power unit status LED	<p>The status indicator LED can be used to identify the following status during startup/power on:</p> <ol style="list-style-type: none">1 Red, steady: Default when power is available.2 Red, flashing: Power is on, self-test is ongoing, operating system is loading.3 Green, flashing: Application is loaded and waiting for communication.4 Green, steady: Power unit is operational. <p>If the LED does not turn steady green after 30-60sec, then the status indicator LED can be used to identify the following issues:</p> <ul style="list-style-type: none">• No color: Power to the power unit is missing.• Red, steady: Internal error.• Red, flashing: Firmware error or self-test failure.• Green, flashing: Communication error to another module.



Note

When troubleshooting the power unit for an CRB 15000 controller, there is only two status:

- Red, the power unit is broken. Replace it.
- Green, the power unit is ok.

Required test equipment

Equipment needed for troubleshooting:

Equipment	Note
Multimeter	
Insulating gloves	
<i>Circuit diagram - OmniCore C90XT</i>	<i>3HAC065464-009</i>

Preparations

	Action
1	Check the FlexPendant for errors and warnings.
2	Power the controller off. Wait one minute, power the controller on.
3	Wait 30-60 seconds after power-on. Make sure that the control system power is in run-time mode.

Continues on next page

Troubleshooting flowchart

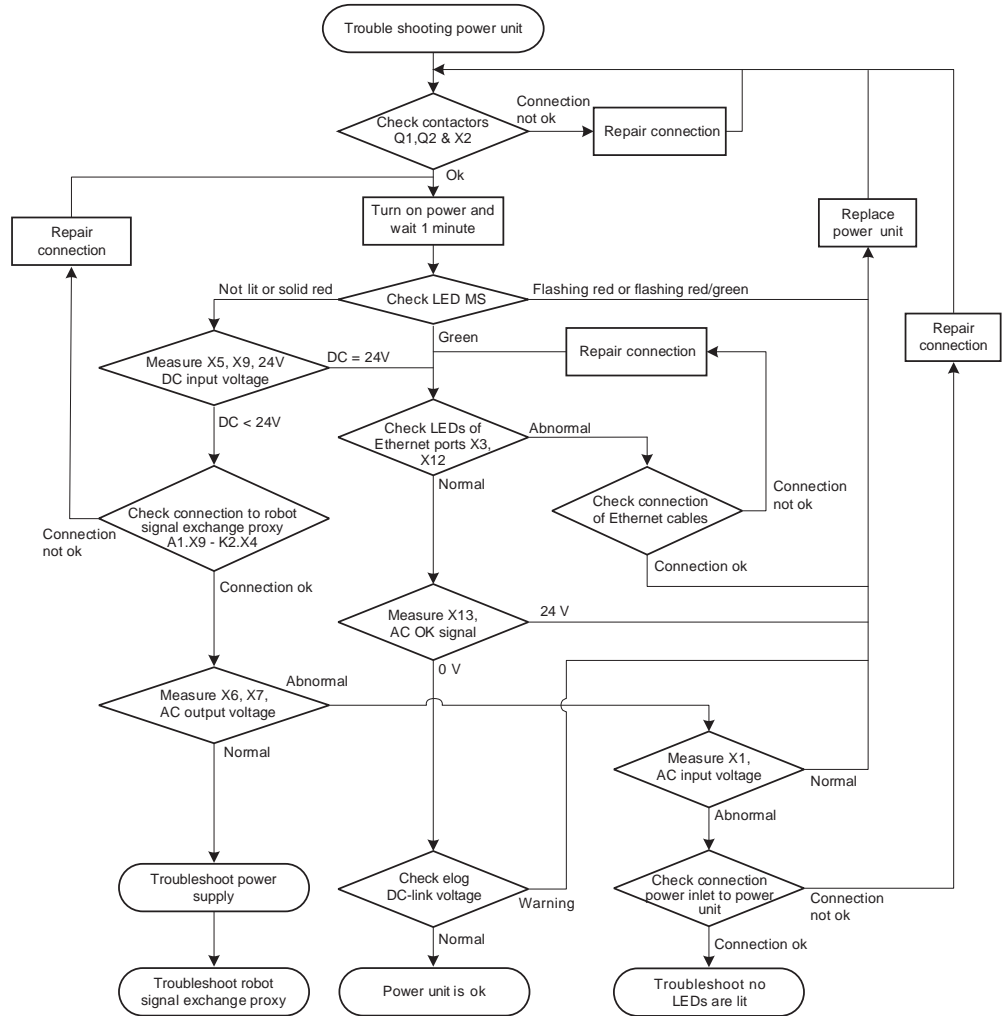

xx1800002357

Troubleshooting procedure

The troubleshooting table is supposed to be used as a detailed instruction together with the troubleshooting flowchart.

	Action	Note
1	<p>Check the connections between connectors Q1, Q2 & X2.</p> <p> Tip</p> <p>For more details, see <i>Circuit diagram - OmniCore C90XT</i>.</p>	<p>Open the door of the controller and check the connections between connectors Q1, Q2 & adapter X2.</p> <p>How to open the controller is described in Opening the robot controller on page 188.</p> <ul style="list-style-type: none"> If the connection is OK, proceed with step 2. If there is a problem with the connection, repair the connection and start over.

Continues on next page

7 Troubleshooting

7.3.4 Troubleshooting the power unit

Continued

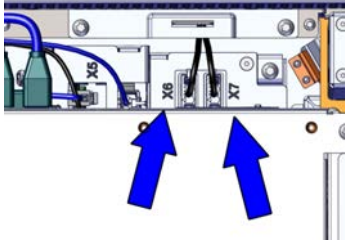
	Action	Note
2	Power on the controller. Check the indicator LED MS on the power unit.	<p>Make sure that the controller power supply is in run-time mode.</p> <p>Wait at least 1 min after power-on.</p> <p>If the LED MS is:</p> <ul style="list-style-type: none"> • Green, proceed with step 8. • Flashing red/green: a firmware upgrade error has occurred. This is not supposed to happen during runtime mode, proceed with step 12. • Pulsing red: replace the power unit, step 12. • Not lit or red: The controller does not have sufficient DC input voltage. Proceed with step 3.
3	Measure the 24 V DC input voltage to the power unit. <ul style="list-style-type: none"> • X5 • X9 	<p>Use a multimeter and insulating gloves.</p> <p>The input voltage should be 24 V.</p> <p>Make sure that connectors X5, X9 are connected properly on both ends.</p> <ul style="list-style-type: none"> • If the 24 V DC input voltage is normal, proceed with step 8. • If the 24 V DC input voltage is abnormal, proceed with the next step.
4	Check connection to the robot signal exchange proxy. <ul style="list-style-type: none"> • A1.X9 (Power unit) - K2.X4 	<p>If the connection is OK, proceed with the next step.</p> <p>If there is a problem with the connection, repair the connection and go to step 2.</p>
5	Measure the AC output voltage.  <p>xx1900000043</p>	<p>Use a multimeter and insulating gloves.</p> <p>The output voltage should be 230 V.</p> <p>Make sure that connectors X6, X7 are connected properly on both ends.</p> <ul style="list-style-type: none"> • If the output voltage is normal, Troubleshooting the power supply on page 430, and then Troubleshooting the robot signal exchange proxy on page 438. • If the output voltage is abnormal, proceed with step 6.
6	Measure the AC input voltage. <ul style="list-style-type: none"> • A1.X1 - A1.K1 	<p>Use a multimeter and insulating gloves.</p> <p>The AC input voltage should be 230 V.</p> <p>Make sure that connector X1 is connected properly on both ends.</p> <ul style="list-style-type: none"> • If the input voltage is normal, proceed with step 12. • If the input voltage is abnormal, proceed with the next step.
7	Check the connection from the power inlet to the power unit.	<ul style="list-style-type: none"> • If the connection is OK, troubleshoot No LEDs are lit on the controller on page 386. • If there is a problem with the connection, repair the connection and start over.
8	Check the LEDs of the Ethernet ports X3, X12 on the power unit.	<ul style="list-style-type: none"> • If the LEDs are normal, proceed with step 10. • If the LEDs are abnormal, proceed with the next step.

Continues on next page

	Action	Note
9	Check the connection of the Ethernet cables.	<ul style="list-style-type: none"> If the connection is OK, proceed with step 12. If there is a problem with the connection, repair the connection and go to step 8.
10	Measure the AC OK signal.	<p>Use a multimeter and insulating gloves. The AC OK should be 0 V.</p> <p>Make sure that connector X13 is connected properly on both ends.</p> <ul style="list-style-type: none"> If the AC OK signal is 24 V, proceed with step 12. If the AC OK signal is 0 V, proceed with the next step.
11	Check event log if there is a message about DC-link voltage.	<p>If message numbers 34401/34402, proceed with step 12.</p> <p>If not, power unit is ok.</p>
12	The power unit may be faulty, replace it and verify that the fault has been fixed.	How to replace the unit is detailed in Replacing the power unit on page 272 .

7 Troubleshooting

7.3.5 Troubleshooting fieldbuses and I/O

7.3.5 Troubleshooting fieldbuses and I/O

Further information

Information about how to troubleshoot the fieldbuses and I/O units can be found in the manual for the respective fieldbus or I/O unit. See [References on page 9](#).

7.3.6 Troubleshooting the 3G Connected Services gateway

Location

The illustration shows the location of the Connected Services gateway in the controller.

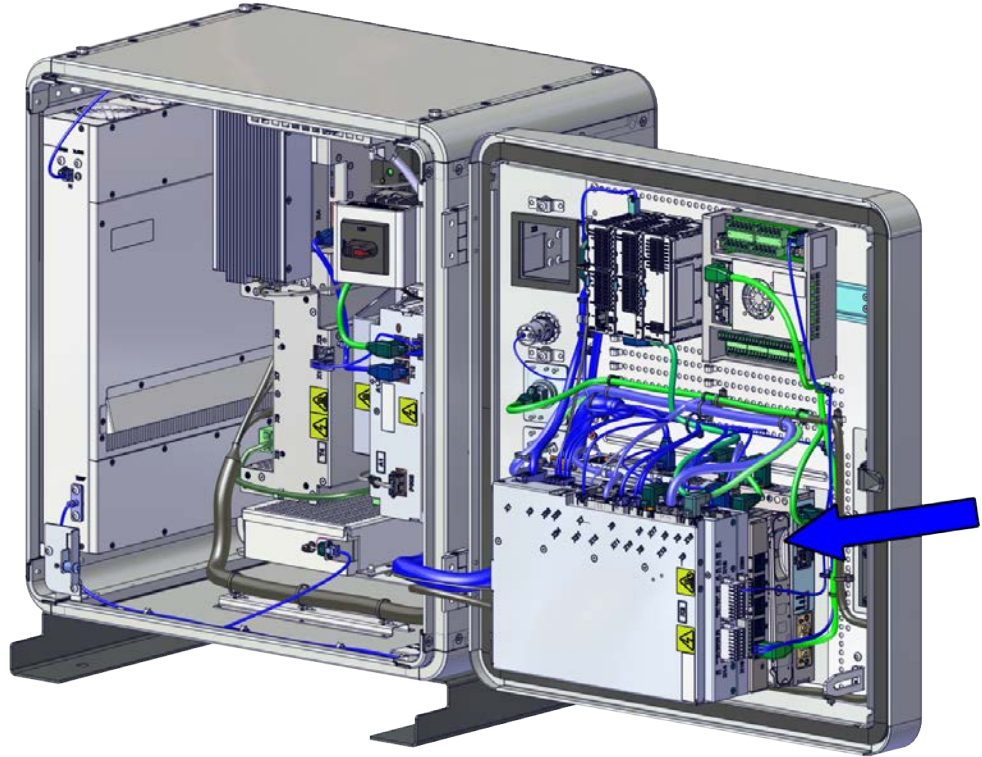

xx1900001466

Continues on next page

7 Troubleshooting

7.3.6 Troubleshooting the 3G Connected Services gateway

Continued

LEDs for options 3G or WiFi

The illustration below shows the LEDs on the Connected Services gateway (3G or WiFi).

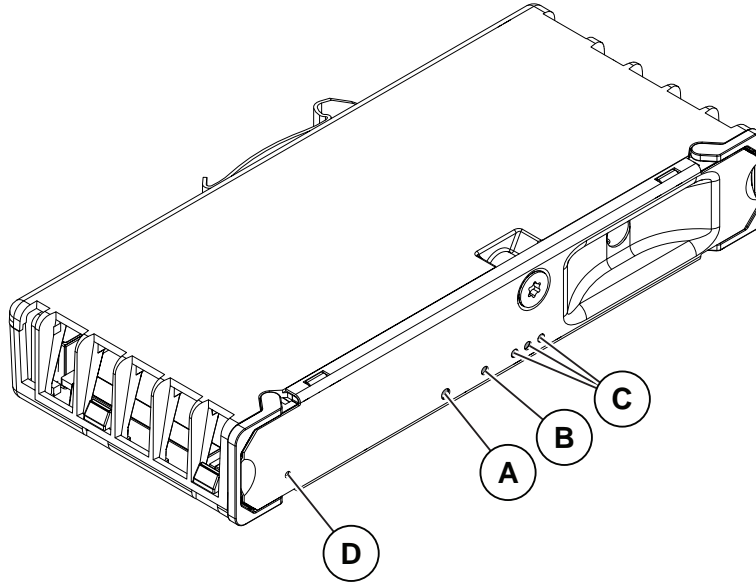

xx180000634

A	STATUS LED
B	LINK, 3G status or WiFi status LED
C	RF, signal strength status LEDs
D	Factory reset pin hole

Description	Significance
STATUS LED (red/green)	<p>Startup sequence:</p> <ol style="list-style-type: none"> 1 Red continuously: Default at power up. 2 Red, flashing: Power on self-test ongoing, operating system is loading. 3 Green flashing: Loading application. 4 Green solid: Startup completed OK. <p>If the LED does not turn steady green after 30-60sec, it can be used to identify the following issues:</p> <p>Fault indication:</p> <ul style="list-style-type: none"> • No color: Power to the unit is missing. • Red, solid or flashing for more than 120s: Internal error. Try a pin reset, if problem persists replace the unit. • Green, flashing continuously: Communication error to another module, view error messages.
LINK	<p>For the Connected Services 3G, an orange LED indicator, externally visible on the front, indicates the status of the 3G connection.</p> <p>Orange:</p> <ul style="list-style-type: none"> • ON, flashing: 3G modem on, searching network. • ON, solid: 3G modem on and connected to network.

Continues on next page

Description	Significance
LINK	For the connected services Wi-Fi, an orange LED indicator, externally visible on the front, indicates the status of the Wi-Fi connection. Orange: <ul style="list-style-type: none"> • ON, flashing: Wi-Fi transceiver on, searching network. • ON, solid: Wi-Fi transceiver on and connected to network.
RF, signal strength status LEDs	Three (3) LEDs indicating the Wi-Fi or 3G signal level. <ul style="list-style-type: none"> • ON: The unit is connected to the network and working ok. • OFF: Problem with connector, antenna, or sim card.
Reset pin hole	The reset pin hole can be used as follows: <ul style="list-style-type: none"> • Short press (less than 5s): The module will reboot to reinitiate communication. • Long press (more than 5s): The module will be reset to factory status before restarting.

Required test equipment

Equipment needed for troubleshooting:

Equipment	Note
Multimeter	
Insulating gloves	

Preparations

	Action
1	Check the FlexPendant for errors and warnings.
2	Power the controller off. Wait one minute, power the controller on.
3	Wait 30-60 seconds after power-on. Make sure that the control system power is in run-time mode.

Continues on next page

7 Troubleshooting

7.3.6 Troubleshooting the 3G Connected Services gateway

Continued

Troubleshooting flowchart for options 3G or WiFi

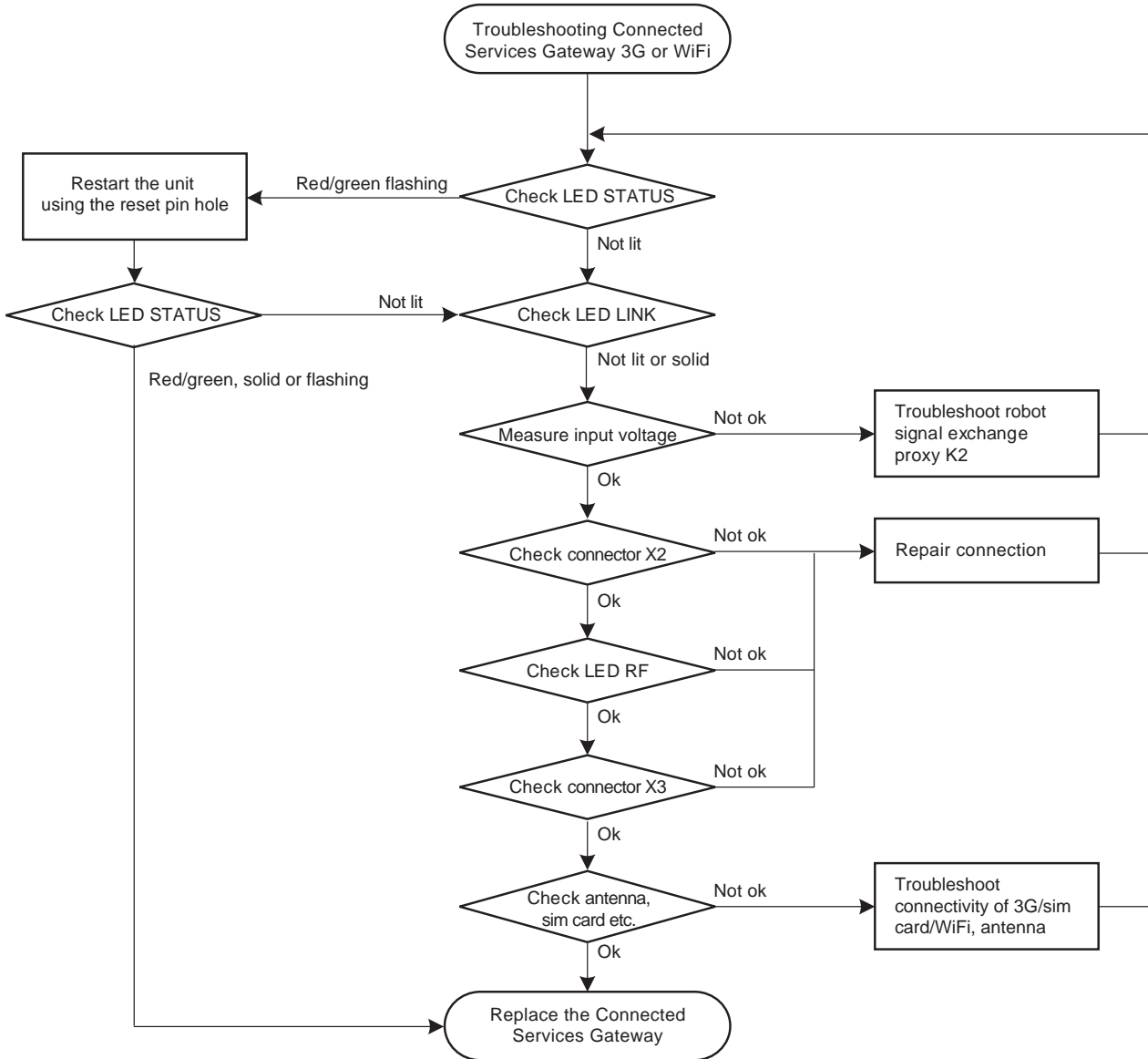

xx1900000139

Troubleshooting procedure for options 3G or WiFi

The troubleshooting table is supposed to be used as a detailed instruction together with the troubleshooting flowchart.

	Action	Note
1	Check the STATUS LED on the Connected Services Gateway.	If the LED is: <ul style="list-style-type: none"> Red/green, flashing: proceed with step 2. OFF, the unit is faulty, or it does not have sufficient input voltage, or the connection of the connector X2 is not ok. Proceed with step 5.
2	Reset the module to factory using the reset pin hole for more than 5s, and restart the controller.	Proceed with step 3.

Continues on next page



	Action	Note
3	Check the STATUS LED on the Connected Services Gateway.	<p>If the LED is:</p> <ul style="list-style-type: none"> • Red/green, flashing: An internal error has occurred, proceed with step 13. • OFF, the unit is faulty, or it does not have sufficient input voltage, or the connection of the connector X2 is not ok. Proceed with step 5.
4	Check the LINK LED on the Connected Services Gateway.	<p>If the LED is:</p> <ul style="list-style-type: none"> • OFF, the unit is faulty, or it does not have sufficient input voltage, or the connection of the connector X2 is not ok. Proceed with step 5. • Flashing: An internal error has occurred, proceed with step 13.
5	Measure the input voltage to the Connected Services Gateway.	<p>Use a multimeter and insulating gloves. The input voltage should be 24 V. Make sure that connector X1 is connected properly on both ends.</p> <ul style="list-style-type: none"> • If the input voltage is normal, proceed with step 6. • If the input voltage is abnormal, Troubleshooting the robot signal exchange proxy on page 438. <p> Tip</p> <p>For more details, see <i>Circuit diagram - OmniCore C90XT</i>.</p>
6	Check that the connector X2 is well connected and the network connection properties are available.	<p>Make sure that connector X2 is connected properly on both ends.</p> <ul style="list-style-type: none"> • If the connection is OK, proceed with step 7. • If there is a problem with the connection, repair the connection and go back to step 3.
7	Check the indicator RF LEDs on the Connected Services Gateway.	<p>If the RF LEDs are:</p> <ul style="list-style-type: none"> • ON, the Connected Services Gateway is connected to network and works well. • OFF, the Connected Services Gateway is faulty or the connection of the connector X3 is not ok. Proceed with step 8.
8	Check that the connector X3 is well connected.	<p>Make sure that connector X3 is connected properly on both ends.</p> <ul style="list-style-type: none"> • If the connection is OK, proceed with step 9. • If there is a problem with the connection, repair the connection and go back to step 7.

Continues on next page

7 Troubleshooting

7.3.6 Troubleshooting the 3G Connected Services gateway

Continued

	Action	Note
9	<p>Check that the right type of the antenna is connected properly.</p> <p> Tip</p> <p>Try moving the antenna to different locations if the RF signal level is low.</p>	<ul style="list-style-type: none">• If the antenna is not working, repair the connection or move the antenna to a location with better RF signal.• If the antenna is ok, proceed with step 13.
10	<p>On the FlexPendant, check the connection log in Backup and Restore.</p>	<p>Verify that the configuration is done correctly.</p> <p>Verify that the mobile operator is detected (for 3G).</p>
11	<p>For 3G, use a cell phone to test that the sim card is working.</p> <p>For WiFi, use a cell phone to verify the WiFi access.</p> <p> Note</p> <p>When testing with a cell phone, use the same configuration on the cell phone.</p>	<p>See the Connected Services Gateway configuration in <i>Operating manual - Integrator's guide OmniCore</i>.</p>
12	<p>For 3G and WiFi, check the antenna connectivity.</p>	
13	<p>The Connected Services Gateway may be faulty, replace it and verify that the problem is resolved.</p>	<p>How to replace the unit is described in Replacing the 3G Connected Services gateway on page 226.</p>

Related information

All documents can be found via myABB Business Portal, www.abb.com/myABB.

The approval code CMIIT ID is displayed on the nameplate of the product.

7.3.7 Troubleshooting the Ethernet switch (DSQC1035)

Location

The illustration shows the location of the Ethernet switch in the controller.

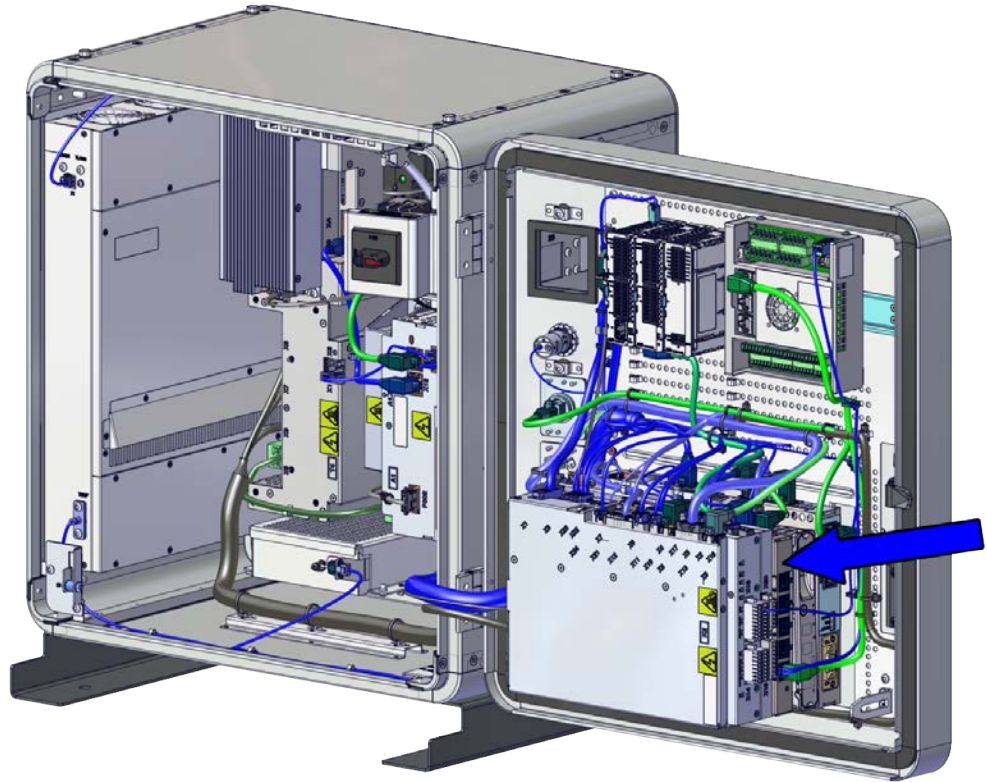

xx1900001465

Continues on next page

7 Troubleshooting

7.3.7 Troubleshooting the Ethernet switch (DSQC1035)

Continued

LEDs

The illustration below shows the indication LEDs on the Ethernet switch.

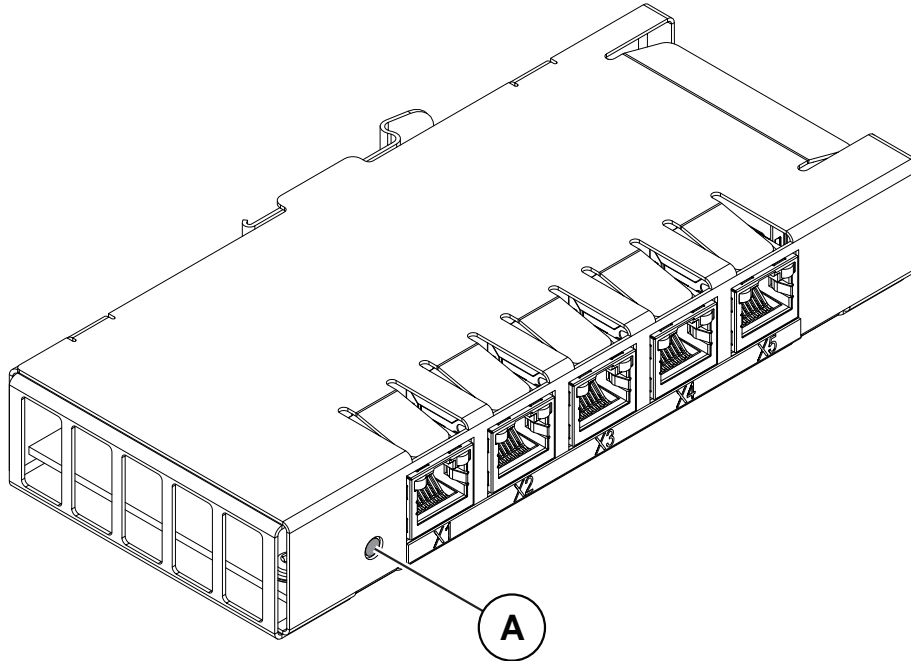

xx180000584

Description	Significance
A	Status LED
Status LED	<p>Startup sequence:</p> <ol style="list-style-type: none">1 No color: Input voltage is outside specified voltage or internal fault in the switch.2 Green, solid: The switch is operational. <p>If the LED does not turn steady green, the status indicator LED can be used to identify the following issues:</p> <p>Fault indication:</p> <ul style="list-style-type: none">• No color: If input voltage is within specified voltage limits and the LED is not lit then replace the switch.
Ethernet LEDs	<p>Shows the status of Ethernet links.</p> <p>Green:</p> <ul style="list-style-type: none">• Off: 10 Mbps data rate is selected.• On: 100/1000 Mbps data rate is selected. <p>Yellow:</p> <ul style="list-style-type: none">• Flashing: The Ethernet is active on link.• Solid: A LAN link is established.• Off: A LAN link is <i>not</i> established.

7.3.8 Troubleshooting the axis computer

Location

The illustration shows the location of the axis computer in the controller.

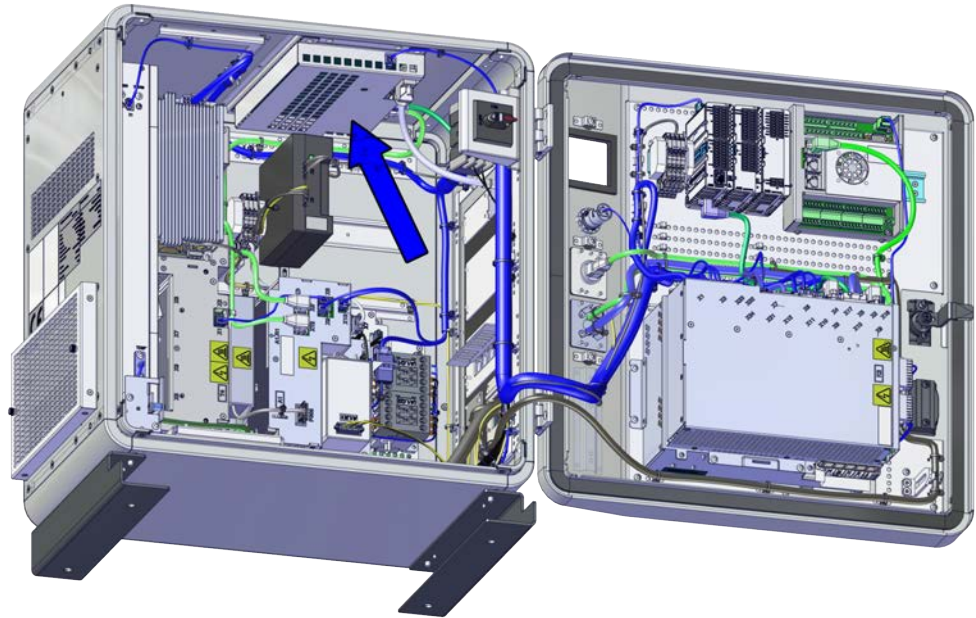

xx1900001462

LEDs

The illustration below shows the LEDs on the axis computer.

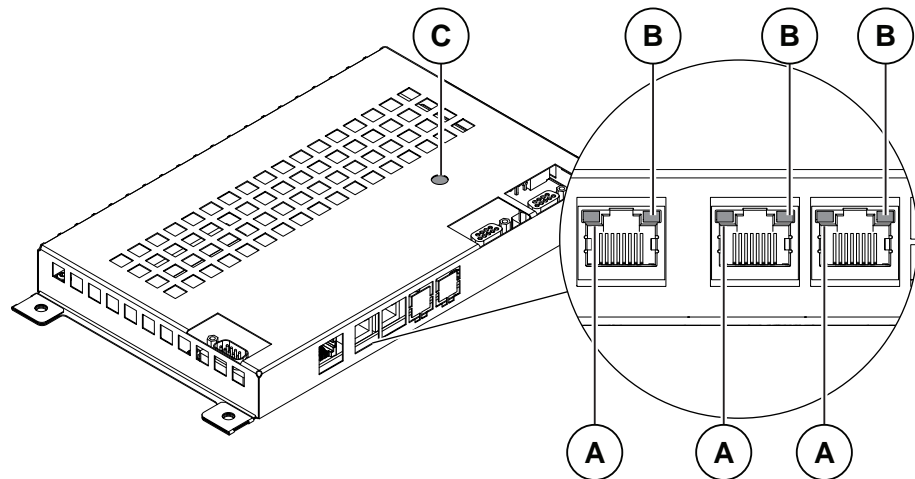

xx1800000581

A	Ethernet LED (yellow)
B	Ethernet LED (green)
C	Status LED

Continues on next page

7 Troubleshooting

7.3.8 Troubleshooting the axis computer

Continued

Description	Significance
Axis computer status LED	<p>Normal sequence during startup:</p> <ol style="list-style-type: none">1 Red, solid: Default at power-up.2 Red, flashing: Establish connection to main computer and load program to axis computer.3 Green, flashing: Start-up of axis computer program and connect peripheral units.4 Green, solid: Start-up sequence ready. Application is running. <p>The following indicates errors:</p> <ul style="list-style-type: none">• No color: No power to axis computer or internal error (hardware/firmware).• Red, solid: The axis computer has failed to initialize basic hardware.• Red, flashing continuously: Missing connection to main computer, main computer start-up problem or RobotWare installation problem.• Green, flashing continuously: Missing connections to peripheral units or RobotWare start-up problem.
Ethernet LED	<p>Shows the status of Ethernet communication.</p> <p>Green:</p> <ul style="list-style-type: none">• Off: 10 Mbps data rate is selected.• On: 100 Mbps data rate is selected. <p>Yellow:</p> <ul style="list-style-type: none">• Flashing: The two units are communicating on the Ethernet channel.• Solid: A LAN link is established.• Off: A LAN link is <i>not</i> established.

7.3.9 Troubleshooting the main computer

Location

The illustration shows the location of the main computer in the controller.

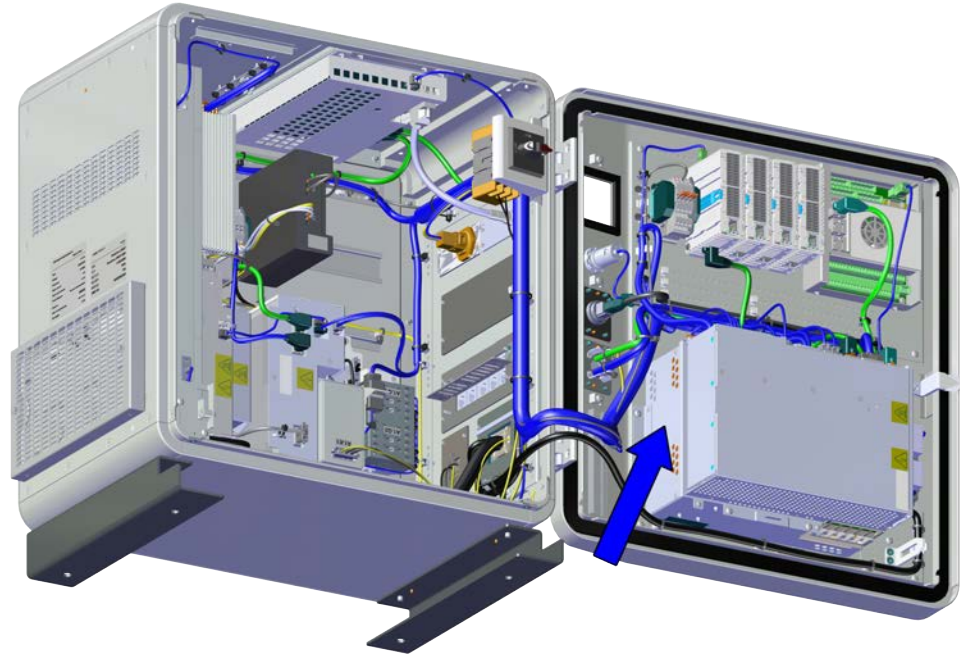

xx1900001468

LEDs

The illustration below shows the LEDs on the main computer:

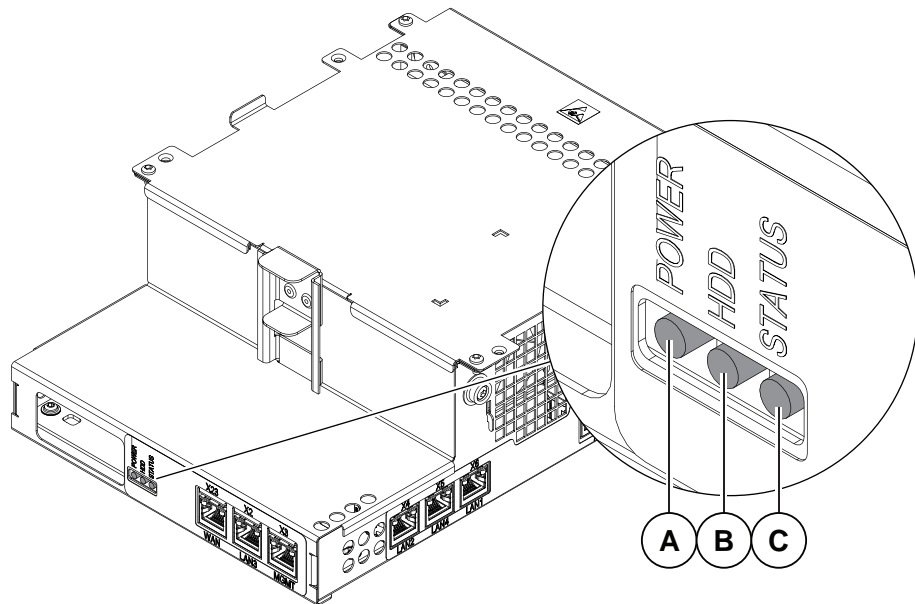

xx1800000585

A	Power status LED
---	------------------

Continues on next page

7 Troubleshooting

7.3.9 Troubleshooting the main computer

Continued

B	HDD status LED
C	Status LED
Description	Significance
Power status, PC PWR (green)	<p>The power status LED indicates the status of the power supply and the main computer hardware and firmware.</p> <p>Normal behavior:</p> <ul style="list-style-type: none"> Off: During a normal startup the LED is off, until the COM Express module inside the computer unit is started. On solid: After completion of startup the LED is steady on. <p>After start-up phase (30-60 seconds):</p> <ul style="list-style-type: none"> Off: Power input voltage is not in normal range. <p>Failure during startup (off between blinks). One to four short blinks, one second off. This is repeated until power off.</p> <ul style="list-style-type: none"> Internal fail of power, FPGA, and/or the COM Express module. Replace the computer unit. <p>Power failure during runtime (fast flashing between blinks). One to five blinks, 20 fast flashing blinks. This is repeated until power off.</p> <ul style="list-style-type: none"> Temporary voltage drop, cycle the power to the controller. Check the power supply voltage to the computer unit. Replace the computer unit.
Disk status, PC HDD	<p>The disk status LED indicates access to the main computer persistent memory.</p> <p>Normal behavior:</p> <ul style="list-style-type: none"> No color at power on: R34 FPGA is loaded on the main board. Yellow: Access (read/write) to internal mass memory.
Computer status, PC STAT (red/green)	<p>The computer status LED indicates the startup progress of RobotWare on the main computer.</p> <p>Normal behavior:</p> <ol style="list-style-type: none"> Red, solid: Default when turning on the power. Red, flashing: Initial self-test is ongoing and the operating system is loading. Green, even flashing (~1Hz): The operating system is loaded and RobotWare is initializing. Green, uneven flashing: The RobotWare system failed to load or is not installed. Green, solid: The computer is operational and the RobotWare system is fully loaded. <p>If the LED does not turn steady green after approximately 5 minutes then the LED can be used to identify the following issues:</p> <ul style="list-style-type: none"> No color: The internal power initialization failed. Restart the controller. Replace the main computer if the problem remains. Red, solid: Internal error. Restart the controller. Replace the main computer if the problem remains. Red, flashing continuously: Failed to load the operating system. Restart the controller. See Controller fails to start on page 402. Replace the main computer if the problem remains. Green, even flashing continuously (~1Hz): Failure during start up. Check error messages on FlexPendant. See Controller fails to start on page 402. Green, uneven flashing: RobotWare Installation Utilities mode.

For information about the LEDs on the AnybusCC slave fieldbus adapter and the PCIExpress master/slave fieldbus board, see the corresponding fieldbus manual.

Continues on next page

Troubleshooting procedure

	Action	Note
1	If the LEDs do not turn steady after approximately 5 minutes then re-start the controller and check the LEDs again.	See LEDs on page 427 .
2	Force start the RobotWare Installation Utilities mode, see Controller fails to start on page 402 .	
3	Re-install RobotWare, if possible.	
4	The main computer may be faulty, replace it and verify that the fault has been fixed.	See Replacing the main computer on page 243 .

7 Troubleshooting

7.3.10 Troubleshooting the power supply

7.3.10 Troubleshooting the power supply

Location

The illustration below shows the location of the system power supply in the controller.

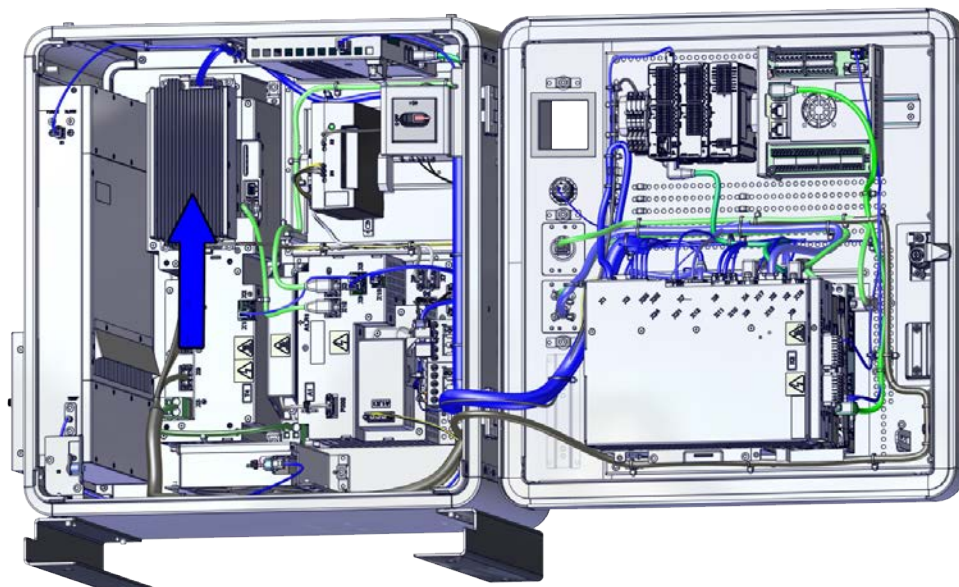

xx200000431

LEDs

The illustration below shows the LEDs on the power supply.

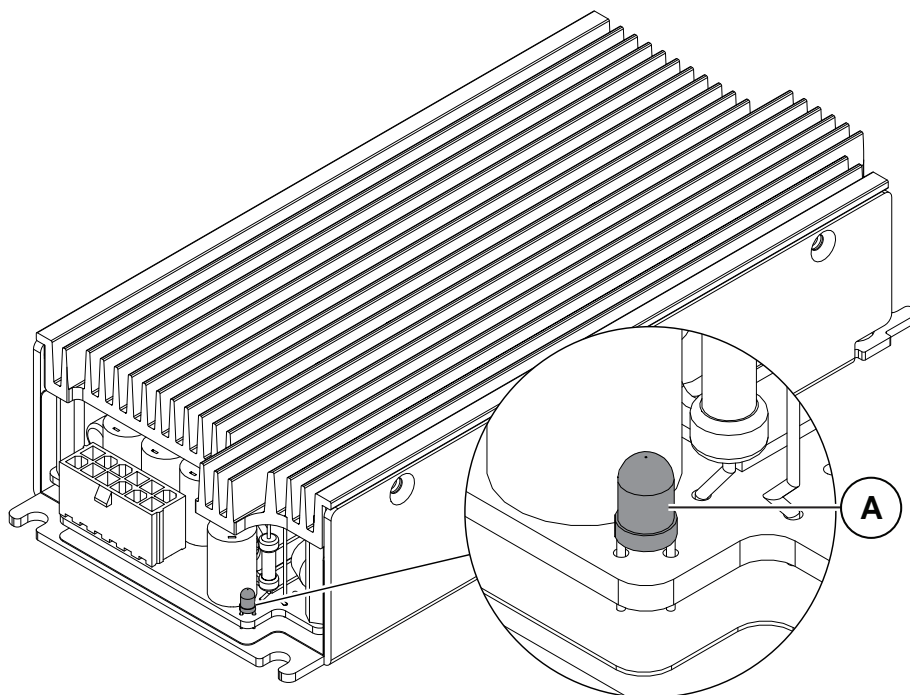

xx180000582

Continues on next page

A	DC OK LED
Description	Significance
DC OK LED	Green: All DC outputs are above the specified minimum levels. Off: One or more DC outputs are below the specified minimum level.

Required test equipment

Equipment needed for troubleshooting.

Equipment	Note
Multimeter	
Insulating gloves	
<i>Circuit diagram - OmniCore C90XT</i>	<i>3HAC065464-009</i>

Preparations

	Action
1	Check the FlexPendant for errors and warnings.
2	Power the controller off. Wait one minute, power the controller on.
3	Wait 30-60 seconds after power-on. Make sure that the control system power is in run-time mode.

Continues on next page

7 Troubleshooting

7.3.10 Troubleshooting the power supply

Continued

Troubleshooting flowchart

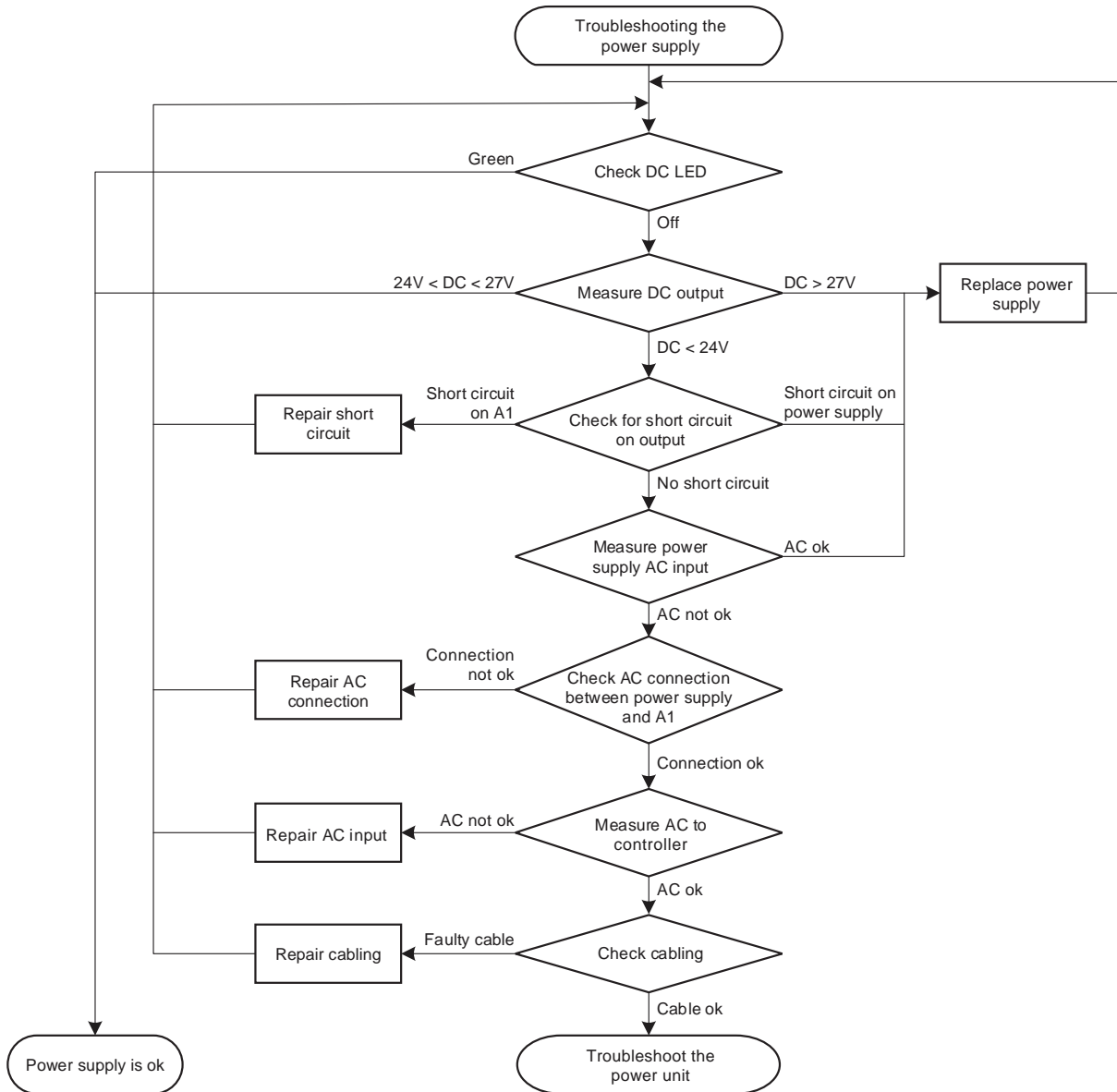

xx1800001823

Troubleshooting procedure

The troubleshooting table is supposed to be used as a detailed instruction together with the troubleshooting flowchart.

	Test	Note
1	Check the LED (labelled DC OK) on the power supply.	If the LED is: <ul style="list-style-type: none"> Green: the power supply should be working properly. Off: either the power supply is faulty or it does not have sufficient input voltage. Proceed with step 2.

Continues on next page

	Test	Note
2	Measure the DC voltage while the output is connected to the robot signal exchange proxy or some other load.	Use a multimeter and insulating gloves. Measure at the DC output connector X2. The voltage should be: $+24\text{ V} < U < +27\text{ V}$. <ul style="list-style-type: none"> If the voltage measured at the load falls below $+24\text{ V}$, voltage drops in the cables and connectors. If the correct voltage is detected and the DC OK LED is green, the power supply is working properly. If the correct voltage is detected and the DC OK LED is off, the power supply is regarded as faulty but does not have to be replaced instantly. If the DC OK voltage is higher than 27 V, proceed with step 10. If the DC OK voltage is below 24 V, proceed with step 3.
3	Power the controller OFF and measure the resistance.	Use a multimeter and insulating gloves.
4	Check for short circuit on DC output. Check both the DC output connector X2 on the power supply and the input connector X1 on the robot signal exchange proxy.	Measure the resistance between voltage pins and ground. The resistance should not be less than 10 ohm .  Note Do not measure the resistance between pins. Dual pins are used for both power supply and ground. <ul style="list-style-type: none"> If no short circuit is found, proceed with step 6. If a short circuit is found on the power supply, proceed with step 10. If a short circuit is found on the robot signal exchange proxy, get that unit working. Verify that the fault has been fixed and restart this guide if necessary.
5	Switch on power to the controller.	
6	Measure the input voltage on the power supply.	Use a multimeter and insulating gloves. Voltage should be: $172\text{ V} < U < 276\text{ V}$ for a 230 V system. <ul style="list-style-type: none"> If the input voltage is correct, proceed with step 10. If no or the wrong input voltage is detected, proceed with step 7.
7	Make sure that the connection between the power supply and the power unit is ok.	<ul style="list-style-type: none"> If the connection is OK, proceed with step 8. If the connection is faulty, repair the connection. Verify that the fault has been fixed and restart this guide if necessary.
8	Make sure that the supplied input voltage to the controller is correct.	<ul style="list-style-type: none"> If the input voltage is correct, proceed with step 9. If the input voltage is faulty, correct it. Verify that the fault has been fixed and restart this guide if necessary.

Continues on next page

7 Troubleshooting

7.3.10 Troubleshooting the power supply

Continued

	Test	Note
9	Check the cabling.	Make sure that the cabling is correctly connected and not faulty. <ul style="list-style-type: none">• If the cabling is OK, see Troubleshooting the power unit on page 411. Verify that the fault has been fixed and restart this guide if necessary.• If the cabling is found unconnected or faulty, connect/replace it. Verify that the fault has been fixed and restart this guide if necessary.
10	The power supply may be faulty, replace it and verify that the fault has been fixed.	See Replacing the power supply on page 277 .

7.3.11 Troubleshooting the process power supply

Location

The process power supply, DSQC 609, is located as shown in the figure below.



CAUTION

If there are two or more power supply units mounted in a row and too close to each other, there will be a heating problem and the units can be damaged.

To avoid damaging the power supply units, the units must be separated with 3 pcs of exterior support.

LEDs

The illustration below shows the LEDs on the process power supply module:

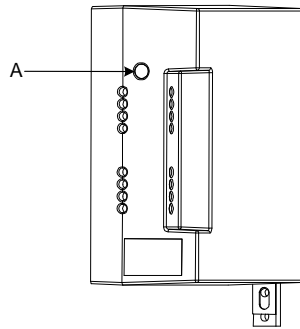

en100000037

A	DC OK
Description	Significance
DC OK	<p>GREEN: When all DC outputs are within the specified output voltage levels.</p> <p>OFF: When DC output voltage is outside the specified voltage levels or turned off due to short circuit or overload.</p>

7 Troubleshooting

7.3.12 Troubleshooting the fieldbus adapter slave

7.3.12 Troubleshooting the fieldbus adapter slave

Location

The illustration shows the location of the fieldbus adapter slave in the controller.

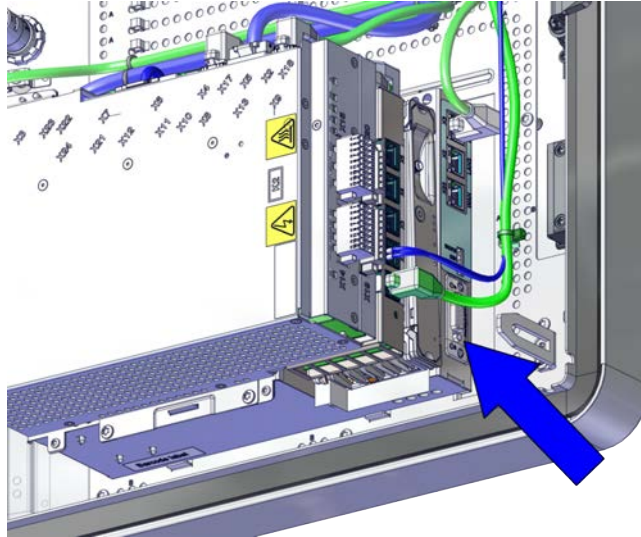

xx1900001474

LEDs

The illustration below shows the indication LEDs on the fieldbus adapter slave.

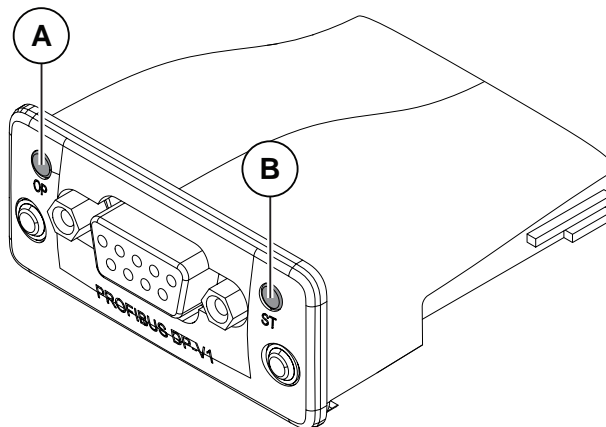

xx1800000586

A	Power LED
B	Status LED

Description	Significance
Power LED	Fault indication: <ul style="list-style-type: none">No color: Input voltage is outside of the specified voltage limits.Green, solid: Input voltage is within the specified limit.

Continues on next page

Description	Significance
Fieldbus adapter slave status LED (red/green)	<p>Startup sequence:</p> <p>Red:</p> <ol style="list-style-type: none"> 1 Red, solid: Loading bootloader. 2 Red, flashing: Power on self-test is ongoing, loading operating system. 3 Green, flashing: Loading RobotWare and waiting for communication. 4 Green, solid: System ready. <p>If the LED does not turn steady green after 30-60 sec, the status indicator LED can be used to identify the following issues:</p> <p>Fault indication:</p> <ul style="list-style-type: none"> • No color: Power to the fieldbus adapter slave is missing. • Red, solid: Internal error. • Red, flashing continuously: Firmware error or self-test failure. • Green, flashing continuously: Communication error to another module. Check the messages on the FlexPendant.

7 Troubleshooting

7.3.13 Troubleshooting the robot signal exchange proxy

7.3.13 Troubleshooting the robot signal exchange proxy

Location

The illustration below shows the location of the robot signal exchange proxy in the controller.

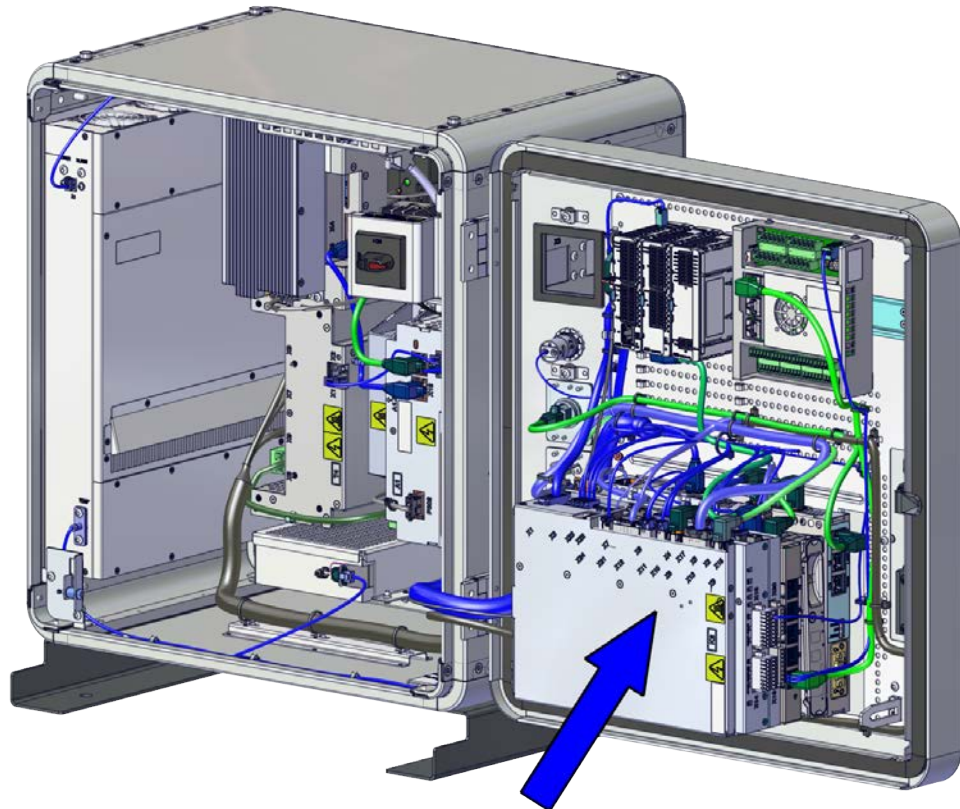

xx1900001464

Continues on next page

LEDs

The illustration below shows the LEDs on the robot signal exchange proxy:

	Description	Significance
MS	<p>Status LED (bi-colored green/red) for the robot signal exchange proxy.</p>  Note The status LED light stays on for a long time after power to the controller is gone. This is due to the capacitors in the robot signal exchange proxy.	<p>The status indicator LED can be used to identify the following status during start-up/power on:</p> <ul style="list-style-type: none"> Red, solid: Default when power is available. Red, flashing: Power on self-test ongoing, operating system is loading. Green, flashing: Application is loaded and waiting for communication. Green, solid: Module is operational. <p>If the LED does not turn steady green after 30-60 sec, the status LED can be used to identify the following issues:</p> <ul style="list-style-type: none"> No color: Power to the robot signal exchange proxy is missing. Red, solid: Internal error. Red, flashing: Firmware error or self-test failure. Green, flashing: Communication error to another module.
AS1/GS1 & AS2/GS2	<p>Automatic Stop/General Stop LEDs (green)</p> <p>AS1/GS1 : Automatic Stop/General Stop LED channel 1</p> <p>AS2/GS2 : Automatic Stop/General Stop LED channel 2</p>	<p>Automatic Stop/General Stop LED can be used to identify the following status:</p> <ul style="list-style-type: none"> No color (not lit): Automatic Stop/General Stop input loop is open. Green, solid: Automatic Stop/General Stop input loop is closed.
ES1 & ES2	<p>External emergency stop LEDs (green)</p> <p>ES1 : External emergency stop LED channel 1</p> <p>ES2 : External emergency stop LED channel 2</p>	<p>External emergency stop LED can be used to identify the following status:</p> <ul style="list-style-type: none"> No color (not lit): External emergency stop input loop is open. Green, solid: External emergency stop input loop is closed.
ES-OUT1 & ES-OUT2	<p>Emergency stop output LEDs (green)</p> <p>ES1 : Emergency stop output LED channel 1</p> <p>ES2 : Emergency stop output LED channel 2</p>	<p>Emergency stop output LED can be used to identify the following status:</p> <ul style="list-style-type: none"> No color (not lit): Emergency stop output is in State 0 (0V) status. Green, solid: Emergency stop output is in State 1 (24V) status.
MON	<p>Motors_ON LED (white)</p>	<p>Motors_ON LED can be used to identify the following status:</p> <ul style="list-style-type: none"> No color: Motors_ON function is off. White, solid: Motors_ON function is on. White, flashing: safety loop is open, for example after an emergency stop.

Continues on next page

7 Troubleshooting

7.3.13 Troubleshooting the robot signal exchange proxy

Continued

	Description	Significance
AC	ACOK LED (green)	ACOK LED can be used to identify the following status: <ul style="list-style-type: none"> No color: AC OK signal is de-active or logic power failure. Green, solid: AC OK signal is active and logic power available.
PS	Internal power (24 V power supply) input LED (green)	Internal power input LED can be used to identify the following status: <ul style="list-style-type: none"> No color: Internal power input voltage is not in normal range. Green, solid: Internal power input voltage is in normal range.
PC	Main computer power output LED (green)	Main computer power output LED can be used to identify the following status: <ul style="list-style-type: none"> No color: Main computer power output voltage is not in normal range. Green, solid: Main computer power output voltage is in normal range.
HMI	FlexPendant power output LED (green)	FlexPendant power output LED can be used to identify the following status: <ul style="list-style-type: none"> No color: FlexPendant power output voltage is not in normal range. Green, solid: FlexPendant power output voltage is in normal range.
EP	External power input LED (green)	External power input LED can be used to identify the following status: <ul style="list-style-type: none"> No color: External power input voltage is not in normal range. Green, solid: External power input voltage is in normal range.

Required test equipment

Equipment needed for troubleshooting.

Equipment	Note
Multimeter	
Insulating gloves	
Circuit diagram - OmniCore C90XT	3HAC065464-009

Preparations

	Action
1	Check the FlexPendant for errors and warnings.
2	Power the controller off. Wait one minute, power the controller on.
3	Wait 30-60 seconds after power-on. Make sure that the control system power is in run-time mode.

Continues on next page

Troubleshooting flowchart

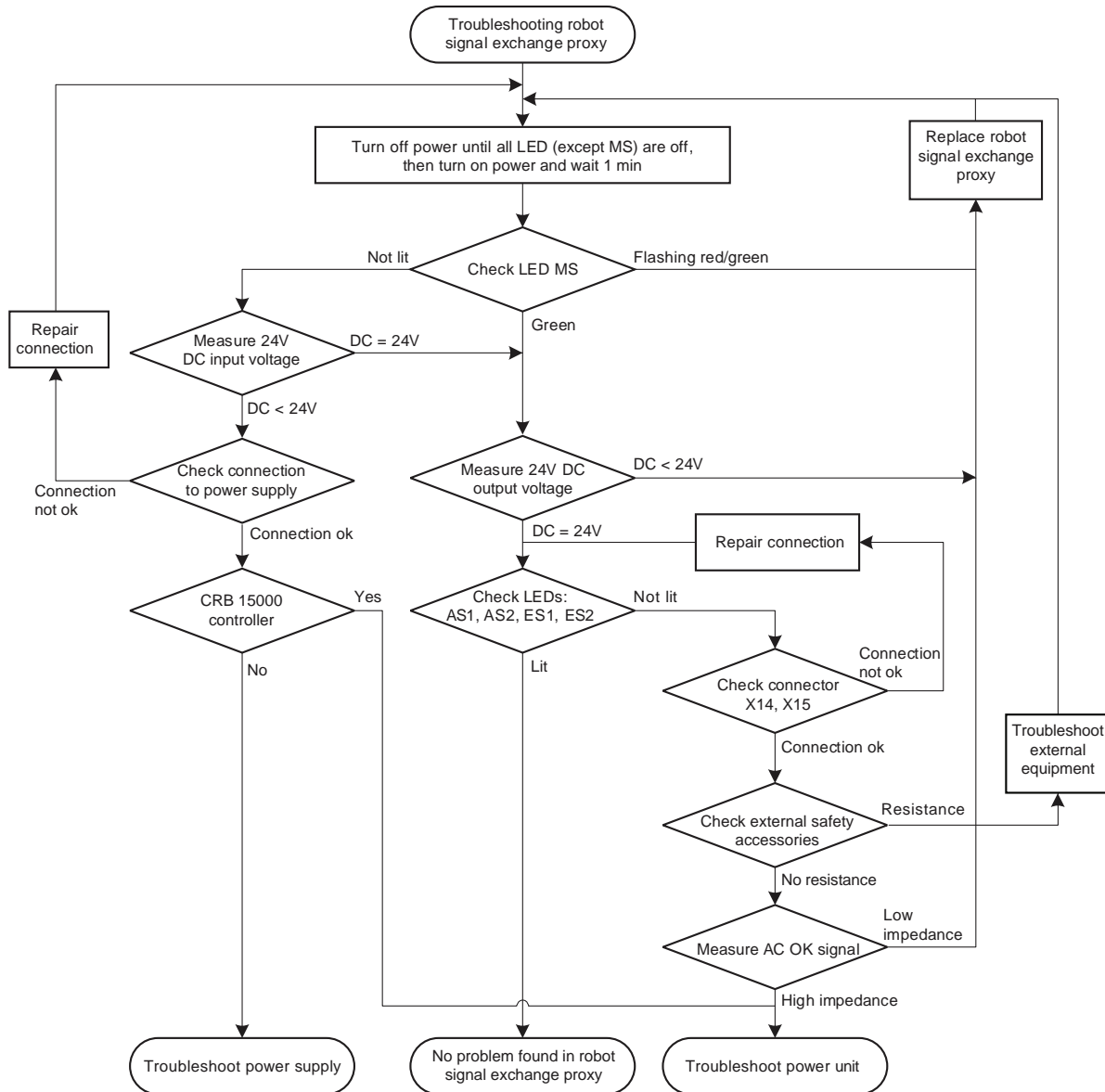

xx1800002356

Troubleshooting procedure

The troubleshooting table is supposed to be used as a detailed instruction together with the troubleshooting flowchart.



	Test	Action
1	Turn off power until all LEDs (except MS, which is solid red) are off. Then turn on power and wait 1 minute.	

Continues on next page

7 Troubleshooting

7.3.13 Troubleshooting the robot signal exchange proxy

Continued

	Test	Action
2	Check the indicator LED MS.	If the LED_MS is: <ul style="list-style-type: none"> • Green, proceed with step 6. • Flashing red/green, a firmware upgrade error has occurred. This is not supposed to happen during runtime mode, proceed with step 11. • OFF, either the robot signal exchange proxy is faulty or it does not have sufficient input voltage. Proceed with step 3.
3	Measure the input voltage to the robot signal exchange proxy.  Tip For more details, see <i>Circuit diagram - OmniCore C90XT</i> .	Use a multimeter and insulating gloves. The input voltage should be 24 V. Make sure that connector X1 is connected properly on both ends. <ul style="list-style-type: none"> • If the input voltage is normal, proceed with step 6. • If the input voltage is abnormal, proceed with step 4.
4	Confirm that the controller is for CRB 15000 or not.	<ul style="list-style-type: none"> • If the controller is for CRB 15000, see Troubleshooting the power unit on page 411. • If the controller is not for CRB 15000, proceed with step 5.
5	Check connection to the power supply unit.	<ul style="list-style-type: none"> • If the connection is OK, Troubleshooting the power supply on page 430. • If there is a problem with the connection, repair the connection and start over.
6	Measure the 24 V DC outputs voltage.	Use a multimeter and insulating gloves. The output voltage should be 24 V. Make sure that connectors X2, X3, X4, X5, X17 and X19 are connected properly on both ends. <ul style="list-style-type: none"> • If the output voltage is normal, proceed with step 7. • If the output voltage is abnormal, proceed with step 11.
7	Check the indicator LEDs AS1, AS2, ES1, ES2.	The indicator LEDs are labelled AS1, AS2, ES1, ES2. If the LEDs LED_AS1, AS2, ES1, ES2 are: <ul style="list-style-type: none"> • On (solid green), the robot signal exchange proxy works well. • Off, either the robot signal exchange proxy is faulty or it does not have sufficient input voltage. Proceed with step 8.
8	Check that the customer interface connectors are connected to X14 and X15.  Tip For more details, see <i>Circuit diagram - OmniCore C90XT</i> .	If the customer interface connectors are not properly connected to X14 and X15, the signals to and from the robot signal exchange proxy will be interpreted incorrectly. <ul style="list-style-type: none"> • If the connection is OK, proceed with step 9. • If there is a problem with the connection, repair the connection and go to step 7.
9	Check external safety accessories.	Use a multimeter and insulating gloves. Measure the continuity in the connector. If there is resistance, troubleshoot the external equipment.

Continues on next page

	Test	Action
10	Measure the AC OK signal.	<p>Use a multimeter and insulating gloves. The AC OK should be 0 V.</p> <p>Make sure that connector X10 is connected properly on both ends.</p> <ul style="list-style-type: none"> • If the AC OK signal is 16 V, see Troubleshooting the power unit on page 411. • If the AC OK signal is 0 V, proceed with step 11.
11	The robot signal exchange proxy may be faulty, replace it and verify that the fault has been fixed.	How to replace the unit is detailed in Replacing the robot signal exchange proxy on page 216 .

This page is intentionally left blank

8 Reference information

8.1 Introduction

General

This chapter includes general information, complementing the more specific information in the different procedures in the manual.

8 Reference information

8.2 Applicable standards

8.2 Applicable standards

General

The product is compliant with ISO 10218-1:2011, *Robots for industrial environments - Safety requirements - Part 1 Robots*, and applicable parts in the normative references, as referred to from ISO 10218-1:2011. In case of deviation from ISO 10218-1:2011, these are listed in the declaration of incorporation. The declaration of incorporation is part of the delivery.

Robot standards

Standard	Description
ISO 9283	Manipulating industrial robots – Performance criteria and related test methods
ISO 9787	Robots and robotic devices – Coordinate systems and motion nomenclatures
ISO 9946	Manipulating industrial robots – Presentation of characteristics

Other standards used in design

Standard	Description
IEC 60204-1	Safety of machinery - Electrical equipment of machines - Part 1: General requirements, normative reference from ISO 10218-1
IEC 61000-6-2	Electromagnetic compatibility (EMC) – Part 6-2: Generic standards – Immunity standard for industrial environments
IEC 61000-6-4	Electromagnetic compatibility (EMC) – Part 6-4: Generic standards – Emission standard for industrial environments
ISO 13849-1:2006	Safety of machinery - Safety related parts of control systems - Part 1: General principles for design, normative reference from ISO 10218-1

Region specific standards and regulations

Standard	Description
ANSI/UL 1740	Safety standard for robots and robotic equipment
CAN/CSA Z 434-03	Industrial robots and robot Systems - General safety requirements
EN ISO 10218-1	Robots and robotic devices — Safety requirements for industrial robots — Part 1: Robots

8.3 Unit conversion

Converter table

Use the following table to convert units used in this manual.

Quantity	Units		
Length	1 m	3.28 ft.	39.37 in
Weight	1 kg	2.21 lb.	
Weight	1 g	0.035 ounces	
Pressure	1 bar	100 kPa	14.5 psi
Force	1 N	0.225 lbf	
Moment	1 Nm	0.738 lbf-ft	
Volume	1 L	0.264 US gal	

8 Reference information

8.4 Standard toolkit for controller

8.4 Standard toolkit for controller

General

All service (repair, maintenance and installation) instructions contain lists of tools required to perform the specified activity. All special tools, that is, all tools that are not considered as standard tools as defined below, are listed in their instructions respectively.

This way, the tools required are the sum of the standard toolkit and any tools listed in the instructions.

Standard toolkit for controller

Tool	Description
Screw driver, Torx	Tx10
Screw driver, Torx	Tx20
Screw driver, Torx	Tx25
Ball tipped screw driver, Torx	Tx25
Screw driver, flat blade	4 mm
Screw driver, flat blade	8 mm
Screw driver, flat blade	12 mm
Screw driver	Phillips-1
Box spanner	8 mm

Toolkit recommended for troubleshooting

Tool	Note
Normal shop tools	Contents as specified above.
Multimeter	-
Camera	To document problems or procedures

8.5 Screw joints

General

This section details how to tighten the various types of screw joints on the controller. The instructions and torque values are valid for screw joints comprised of metallic materials and do *not* apply to soft or brittle materials.

Tightening torque

Before tightening any screw, note the following:

- Determine whether a standard tightening torque or special torque is to be applied. The standard torques are specified in the tables below. Any special torques are specified in the Repair, Maintenance or Installation procedure description. Any special torque specified overrides the standard value.
- Use the *correct tightening torque* for each type of screw joint.
- Only use *correctly calibrated* torque keys.
- Always *tighten the joint by hand*, and never use pneumatical tools.
- Use the *correct tightening technique*, i.e. *do not* jerk. Tighten the screw in a slow, flowing motion.
- Maximum allowed total deviation from the specified value is **10%**!

The table below specifies the recommended standard tightening torque for *oil-lubricated screws with slotted or cross-recess heads*.

Dimension	Tightening torque (Nm) Class 4.8, oil-lubricated
M2.5	0.25
M3	0.5
M4	1.2
M5	2.5
M6	5.0

8 Reference information

8.6 Weight specifications

8.6 Weight specifications

Definition

In all repair and maintenance instructions, weights of the components handled are sometimes specified. All components exceeding 22 kg (50 lbs) are high-lighted in this way.

To avoid injury, ABB recommends the use of lifting equipment when handling components with a weight exceeding 22 kg.

Example

Below is an example of how a weight specification is presented:



CAUTION

The transformer weighs 55 kg! All lifting equipment used must be sized accordingly!

8.7 Lifting accessories and lifting instructions

General

Many repair and maintenance activities require different pieces of lifting accessories, which are specified in each procedure.

The use of each piece of lifting accessories is *not* detailed in the activity procedure, but in the instruction delivered with each piece of lifting accessories.

The instructions delivered with the lifting accessories should be stored for later reference.

This page is intentionally left blank

9 Spare parts

Spare part level

ABB spare parts are categorized into two levels, L1 and L2. Always check the part level before conducting a service work on a spare part.

- L1 spare parts

The L1 parts can be replaced in the field. The maintenance and replacement instructions given in the related product manuals must be strictly followed. If there are any problems, contact your local ABB for support.

- L2 spare parts

To replace the L2 parts require specialized training and might need special tools. Only ABB field service personnel or qualified personnel trained by ABB can replace L2 parts.

- L3 spare parts

L3 spare parts shall only be replaced or repaired by qualified ABB service technician with knowledge of the application due to risk of injury to equipment. Improper installation may void warranty.

Continues on next page

9 Spare parts

9.1 Controller parts

9.1 Controller parts



Note

Removed parts and spare parts must not be disassembled or opened.

Continues on next page

9.1.1 Controller system parts

Drive units

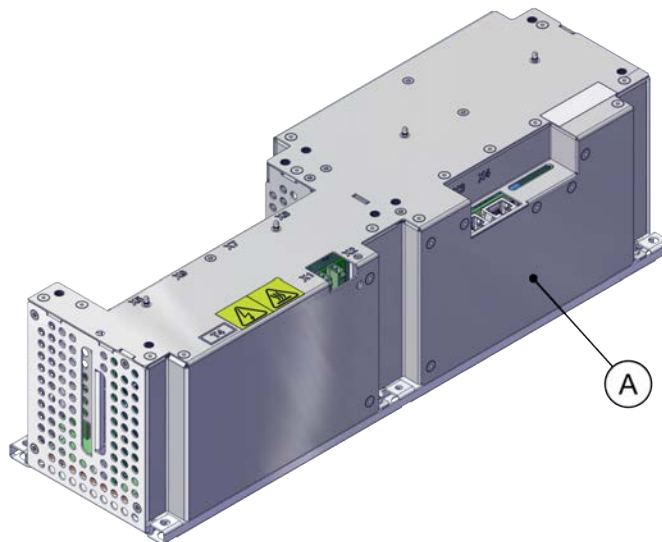

xx1900001930

	Spare part number	Description	Type	Spare part level
A	3HAC063913-001	Drive	DSQC3041	L1

Power units

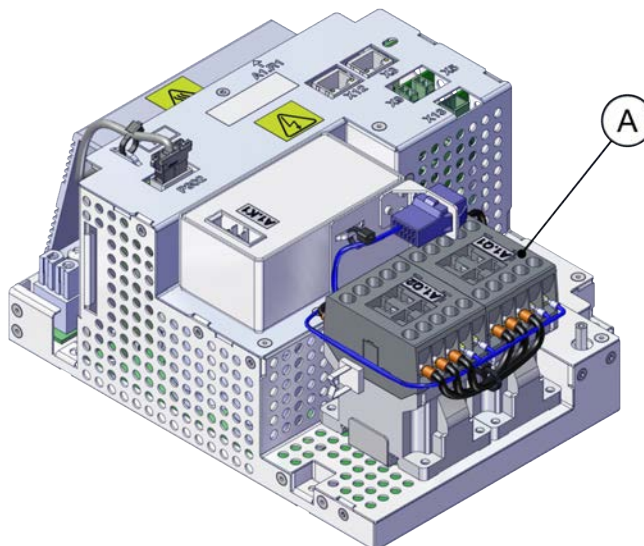

xx1900001931

	Spare part number	Description	Type	Spare part level
A	3HAC059152-001	Power unit	DSQC3044	L1

Continues on next page

9 Spare parts

9.1.1 Controller system parts

Continued

Harness ETH outlet connection

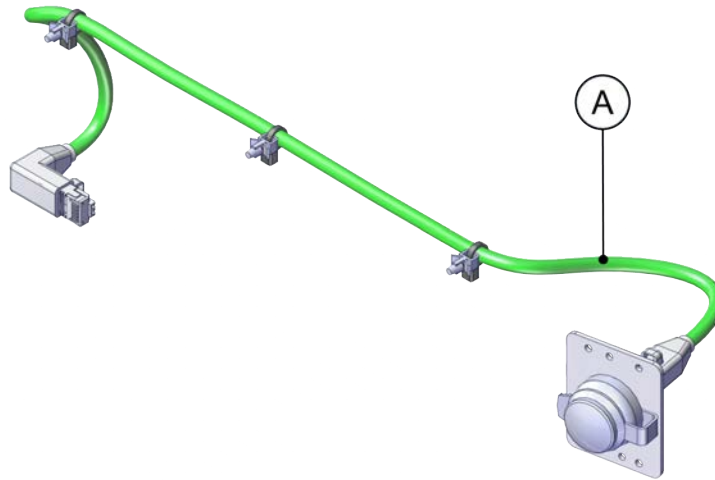

xx1900001941

	Spare part number	Description	Type	Spare part level
A	3HAC070053-001	Harness ETH outlet with cable		L1

Harness TPU connection

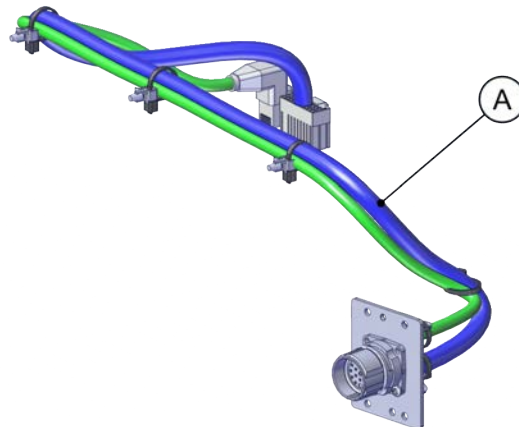

xx1900001943

	Spare part number	Description	Type	Spare part level
-	3HAC069673-001	Harness TPU connection		L1

Continues on next page

Harness motors power

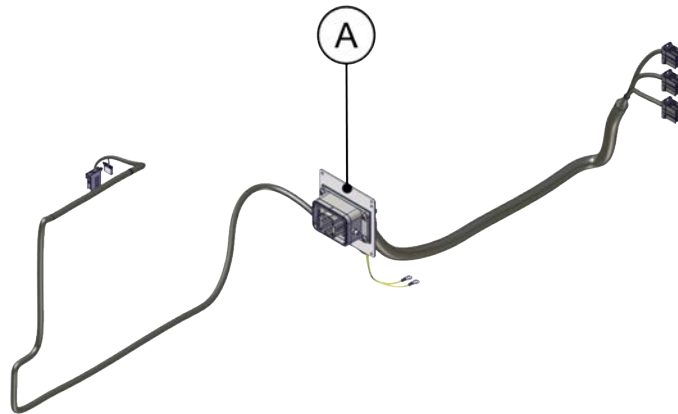

xx1900001944

	Spare part number	Description	Type	Spare part level
A	3HAC069672-001	Harness Motors power LV 6-axis		L1

Axis computer

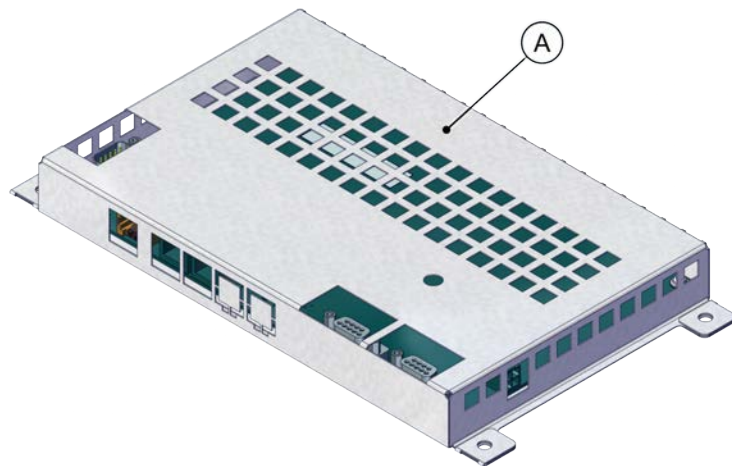

xx1900001927

	Spare part number	Description	Type	Spare part level
A	3HAC029157-001	Axis Computer	DSQC 668	L1

9 Spare parts

9.1.2 Mains connection parts

9.1.2 Mains connection parts

Mains power connection

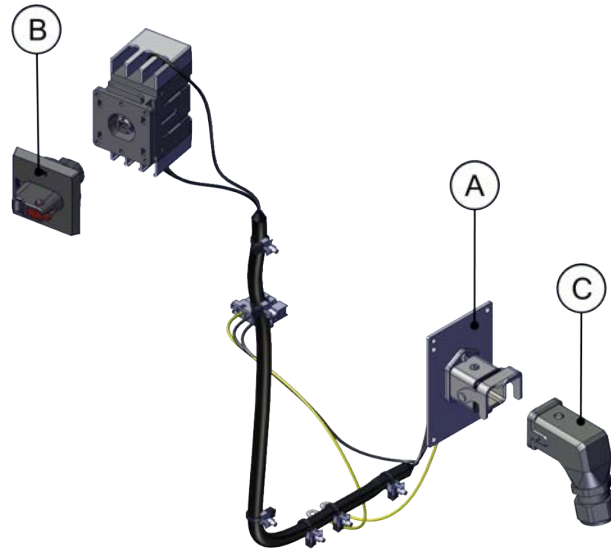

xx1900001946

	Spare part number	Description	Type	Spare part level
A	3HAC067661-001	Harness AC input with SW	Harness-Mains connection	L1
B	3HAC037699-001	Handle for 6 mm switch		L1
C	3HAC070308-001	Connector AC power inlet		L1

9.1.3 Logic parts

Robot signal exchange proxy

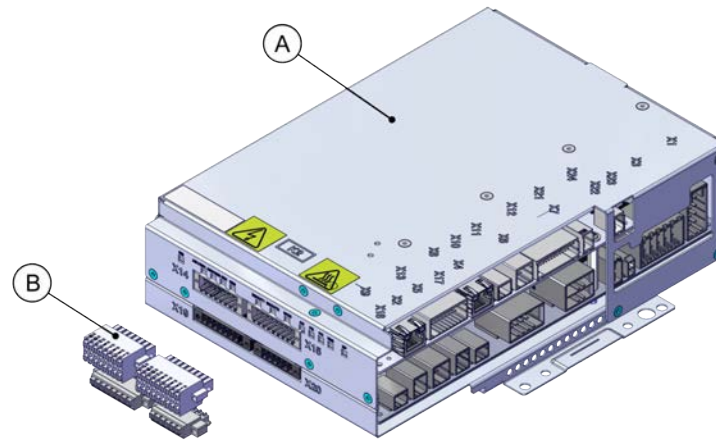

xx1900001936

	Spare part number	Description	Type	Spare part level
A	3HAC064662-001	Signal exchange	DSQC3037	L1
B	3HAC065107-001	Harness Short-circuit connector	Mating connector for robot signal exchange proxy.	L1

Main computer

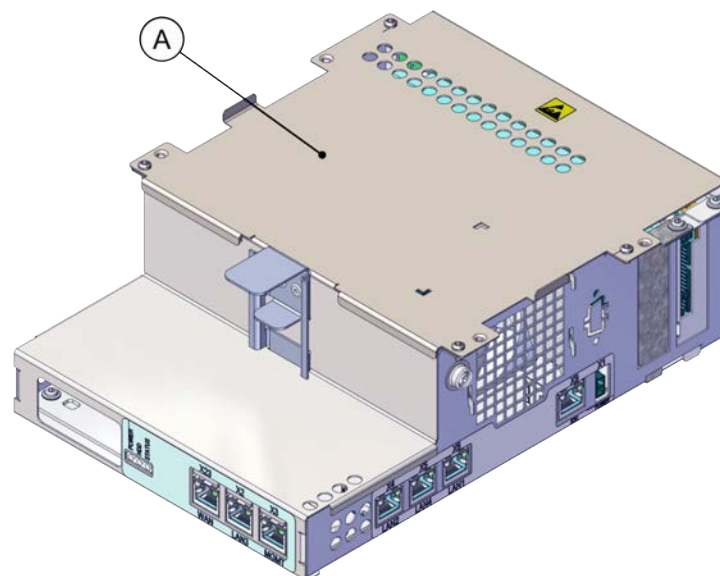

xx1900001933

Continues on next page

9 Spare parts

9.1.3 Logic parts

Continued

	Spare part number	Description	Type	Spare part level
A	3HAC063061-001	Main computer module assembly		L1

DeviceNet board

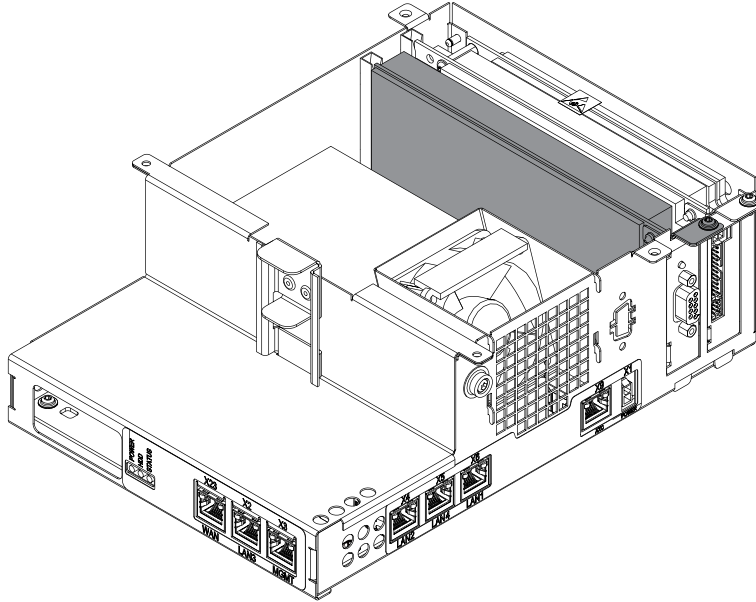

xx1800003420

	Spare part number	Description	Type	Spare part level
A	3HAC043383-001	DeviceNet Board (option)	DSQC1006	L1

Connected Services gateway

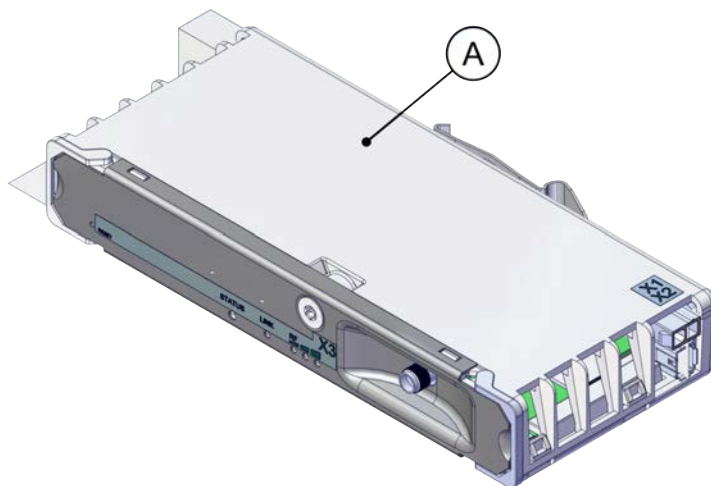

xx1900001934

Continues on next page

9 Spare parts

9.1.3 Logic parts *Continued*

	Spare part number	Description	Type	Spare part level
A	3HAC060960-001	Connected Services-3G [3013-3] (baseline)		L1
B	3HAC028459-001	Magnetic roof antenna, 3G (baseline)		L1
C	3HAC060962-001	Connected Services-WiFi [3013-2] (option)		L1
D	3HAC059424-001	Magnetic roof antenna, WiFi (option)		L1
E	3HAC061701-001	Connected Services-Wired [3013-1] (option)	DSQC1041	L1

9 Spare parts

9.1.4 Application parts

9.1.4 Application parts

CTM-01

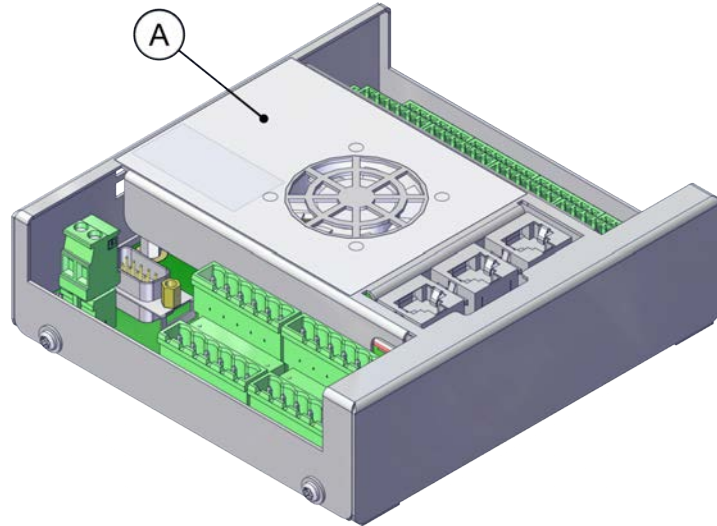

xx1900001938

	Spare part number	Description	Type	Spare part level
A	3HNA027579-001	Conveyor tracking module [3103-1]	DSQC2000	L1
-	3HNA029345-001	CONNECTOR KIT - DSQC2000		L1
-	3HAC069618-001	Harness 24V_CTM	Power cable of CTM	L1

Ethernet switches

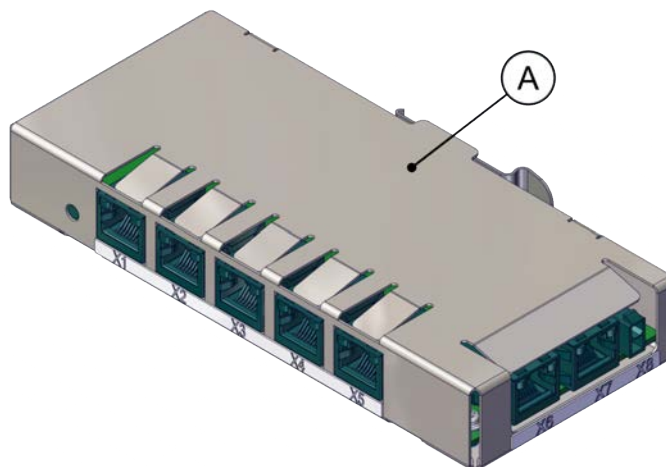

xx1900001935

Continues on next page

	Spare part number	Description	Type	Spare part level
A	3HAC059187-001	Ethernet Extension switch [3014-1] (option)	DSQC1035	L1

Power supply device

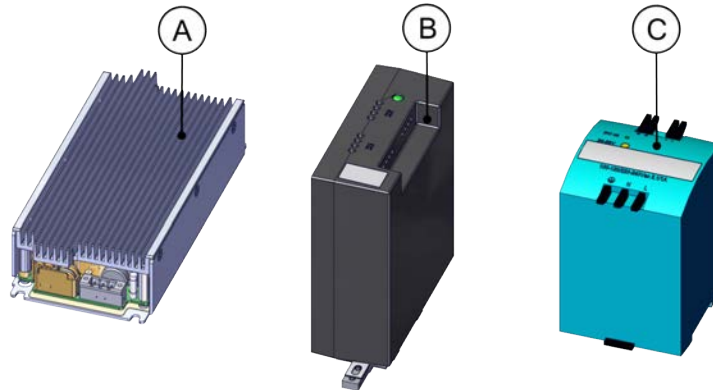

xx1900001932

	Spare part number	Description	Type	Spare part level
A	3HAC071301-001	Power supply	DSQC3035	L1
B	3HAC14178-1	DSQC 609 power supply	DSQC 609	L1

9 Spare parts

9.1.4 Application parts

Continued

Scalable I/O devices

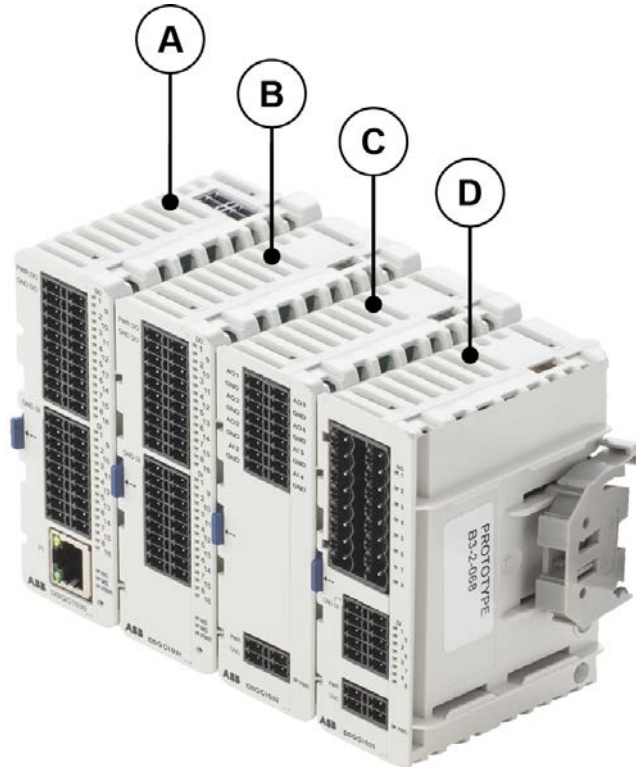

xx1900001939

	Spare part number	Description	Type	Spare part level
A	3HAC058663-001	Scalable I/O Digital base [3032-1] (option)	DSQC1030	L1
-	3HAC060919-001	Connectors digital base/add on		L1
B	3HAC058664-001	Digital add-on [3033-2] (Add-on)	DSQC1031	L1
C	3HAC058665-001	Analog add-on [3034-2] (Add-on)	DSQC1032	L1
-	3HAC060925-001	Connectors I/O Analog (Add-on)		L1
D	3HAC058666-001	Relay add-on [3035-2] (Add-on)	DSQC1033	L1
-	3HAC060926-001	Connectors I/O Relay (Add-on)		L1

Continues on next page

Safety digital base device

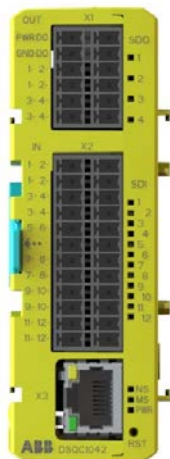

xx210000990

	Spare part number	Description	Type	Spare part level
-	3HAC062908-001	DSQC1042 Extended safety		L1
-	3HAC069538-001	Connectors Safety I/O		L1

9 Spare parts

9.1.5 Cabinet parts

9.1.5 Cabinet parts

Fans

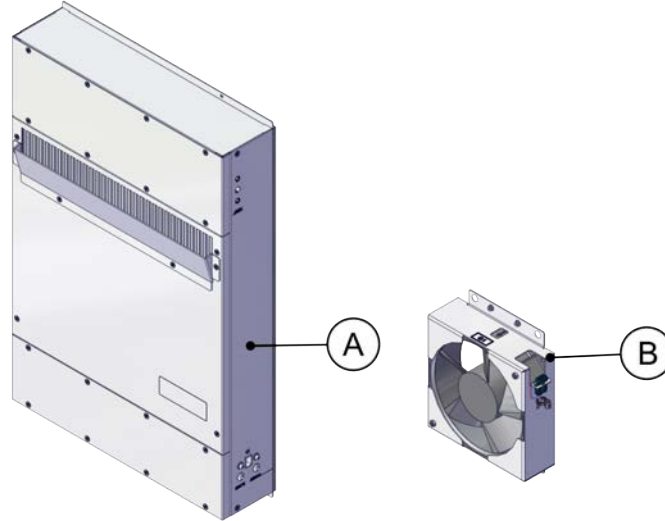

xx1900001929

	Spare part number	Description	Type	Spare part level
B	3HAC077005-001	Standard size silent fan		L1
A	3HAC065526-001	Heat exchanger		L1

Main computer fan

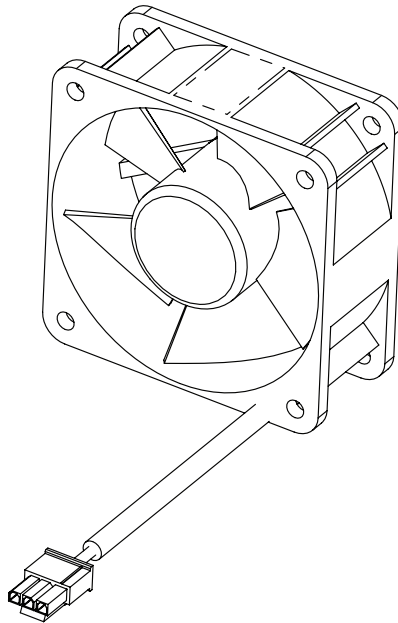

xx2100002181

Continues on next page

	Spare part number	Description	Type	Spare part level
-	3HAC060653-001	Fan with contact	Main computer fan	L1

Process, fieldbus and I/O connectors



xx1900001481

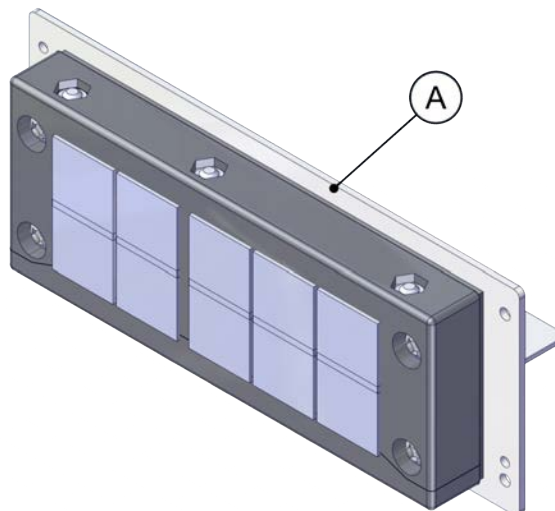

xx1900001928

Continues on next page

9 Spare parts

9.1.5 Cabinet parts

Continued

	Spare part number	Description	Type	Spare part level
A	3HAC066396-001	Cable grommet asm (option)		L1

LED indicator

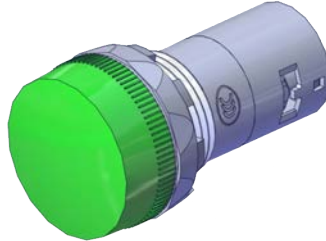

xx1900002451

	Spare part number	Description	Type	Spare part level
-	3HAC065549-001	LED indicator		L1

TPU cover



xx1900002452

	Spare part number	Description	Type	Spare part level
-	3HAC067213-001	TPU cover		L1

Continues on next page

Air filter

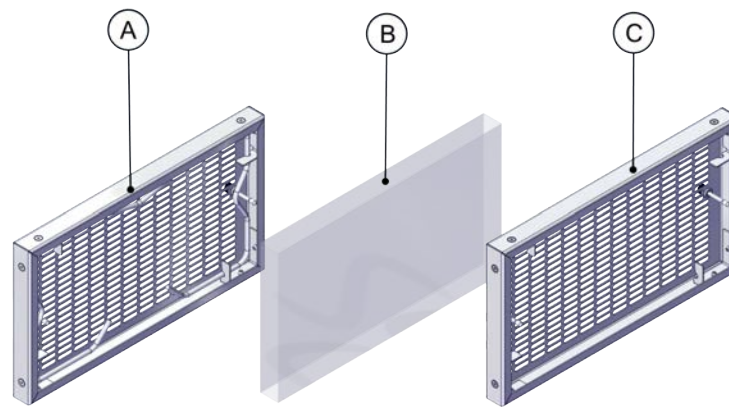

xx1900001945

	Spare part number	Description	Type	Spare part level
A	3HAC068416-001	Air filter-Fine filter		L1
B	3HAC068543-001	Air filter (Polymeric)		L1
C	3HAC068415-001	Air filter-coarse filter		L1

9 Spare parts

9.1.6 Miscellaneous parts

9.1.6 Miscellaneous parts

Manipulator signal connectors (SMB)

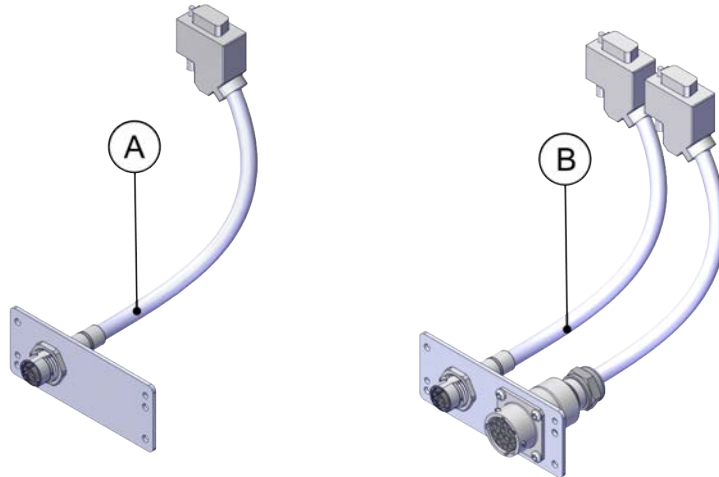

xx1900001942

	Spare part number	Description	Type	Spare part level
A	3HAC069674-001	Harness Single SMB connection		L1
B	3HAC069675-001	Harness Double SMB connection (option)		L1

Fieldbus adapter slaves

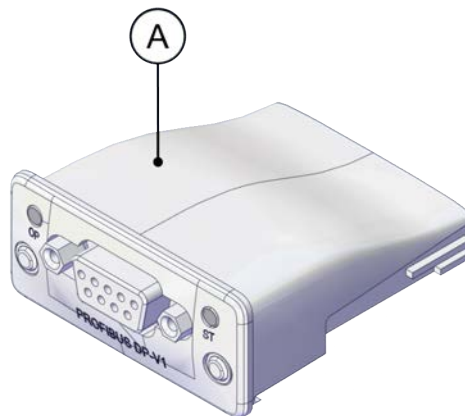

xx1900001937

	Spare part number	Description	Type	Spare part level
-	3HAC062390-001	Fieldbus slot cover (baseline)		L1

Continues on next page

	Spare part number	Description	Type	Spare part level
A	3HAC045973-001	DeviceNet Slave Fieldbus adaptor [3030-1] (option)	DSQC1004	L1

End clamp

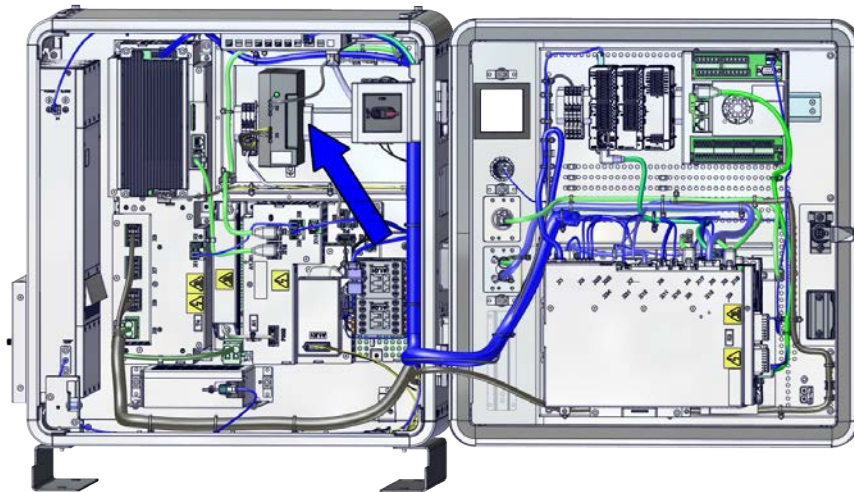

xx2000000529

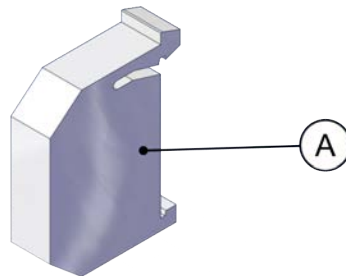

xx1900001940

	Spare part number	Description	Type	Spare part level
A	3HAB7983-1	End clamp		L1

Continues on next page

9 Spare parts

9.1.6 Miscellaneous parts

Continued

Cable grommet asm



xx1900001480

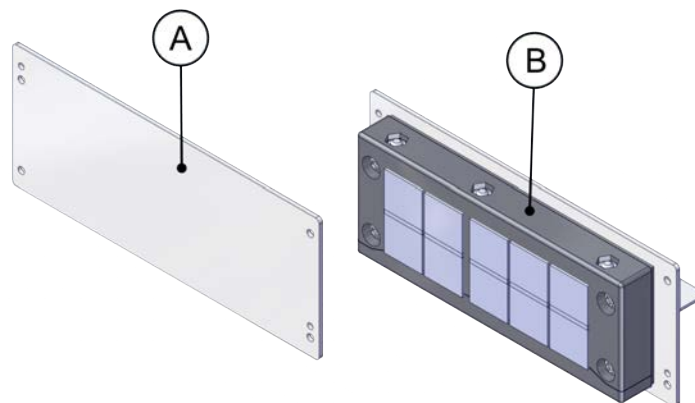

xx1900001947

	Spare part number	Description	Type	Spare part level
A	3HAC069954-001	Blind plate (baseline)		L1
B	3HAC066396-001	Cable grommet asm		L1

Continues on next page

Vision parts

Spare part number	Description	Type	Spare part level
3HAC053944-001	8 mm camera lens, LTC-08F		L1
3HAC053944-002	12.5 mm camera lens, LFC-12.5F		L1
3HAC053944-003	16 mm camera lens, LFC-16F1		L1
3HAC053944-004	25 mm camera lens, LFC-25F1		L1
3HAC087266-001	8 mm camera lens, LMC-ML-M0822UR		L1
3HAC087267-001	12.5 mm camera lens, LMC-ML-M1218UR		L1
3HAC087268-001	16 mm camera lens, LMC-ML-M1616UR		L1
3HAC087269-001	25 mm camera lens, LMC-ML-M2516UR		L1
3HAC053953-001	Integr Vision camera med. Res	DSQC1020	L1
3HAC053954-001	Integr Vision camera high res	DSQC1021	L1
3HAC087074-001	Integrated vision camera 2MPx	DSQC1098	L1
3HAC087075-001	Integrated vision camera 5MPx	DSQC1099	L1
3HAC051753-003	Integr Vision power cable 10 m		L1
3HAC075443-002	Integr Vision ethernet cable 10 m		L1
3HAC051753-004	Integr Vision power cable 15 m		L1
3HAC075443-003	Integr Vision ethernet cable 15 m		L1

Continues on next page

9 Spare parts

9.1.6 Miscellaneous parts

Continued

Blind plate



xx2000000453

	Spare part number	Description	Type	Spare part level
-	3HAC069953-001	Blind plate		L1

Service port connector

Spare part number	Description	Type	Spare part level
3HAC064848-001	Service port connector		L1

9.1.7 Cables

Cables

Cables on the frame

	Spare part number	Description	Type	Spare part level
-	3HAC071430-001	Harness AC input package	Harness A1.X6, A1.X7 - T2,T5	L1
-	3HAC066527-001	Harness contactors signals	Harness A1.X2 - K2.X6, K2.X11	L1
-	3HAC066520-001	Harness AC_OK signal	Harness A1.X13 - K2.X10	L1
-	3HAC066521-001	Harness Temp Sensor	Harness K2.X21 - TempSensor	L1
-	3HAC066522-001	Harness 24_SYS_DRV	Harness K2.X4 - A1.X9	L1
-	3HAC066523-001	Harness 24_SYS	Harness K2.X3 - K6.X1, K3.X1, K5.1.X4/ K3.1.X4, K7.X1	L1
-	3HAC066524-001	Harness 24_Trunk	Harness K2.X1 - T2.X2	L1
-	3HAC066526-001	Harness 24_Cooling	Harness K2.X17 - Cooling	L1

Cables on the drive unit

	Spare part number	Description	Type	Spare part level
-	3HAC063344-001	Harness DC-BUS	Harness A1.X4 - T4.X5	L1
-	3HAC064389-001	Harness 24_SYS_DRV	Harness A1.X5 - T4.X1	L1
-	3HAC059894-001	Harness EtherCAT	Harness T4.X3 - A1.X12	L1

Cables on the Connected Services unit

Cables on the power supply

	Spare part number	Description	Type	Spare part level
-	3HAC069617-001	Harness AC input of power supply		L1

Cables on the robot signal exchange proxy

	Spare part number	Description	Type	Spare part level
-	3HAC064091-001	Harness 24_PC	Harness K2.X2 - K4.X8, A2.X1	L1
-	3HAC059273-001	Harness dual channel safety	Harness K2.X12 - K3.X6, K3.X7	L1

9 Spare parts

9.2 FlexPendant parts

9.2 FlexPendant parts

FlexPendant parts

The illustration below shows the placement of the parts in the recommended spare part list.

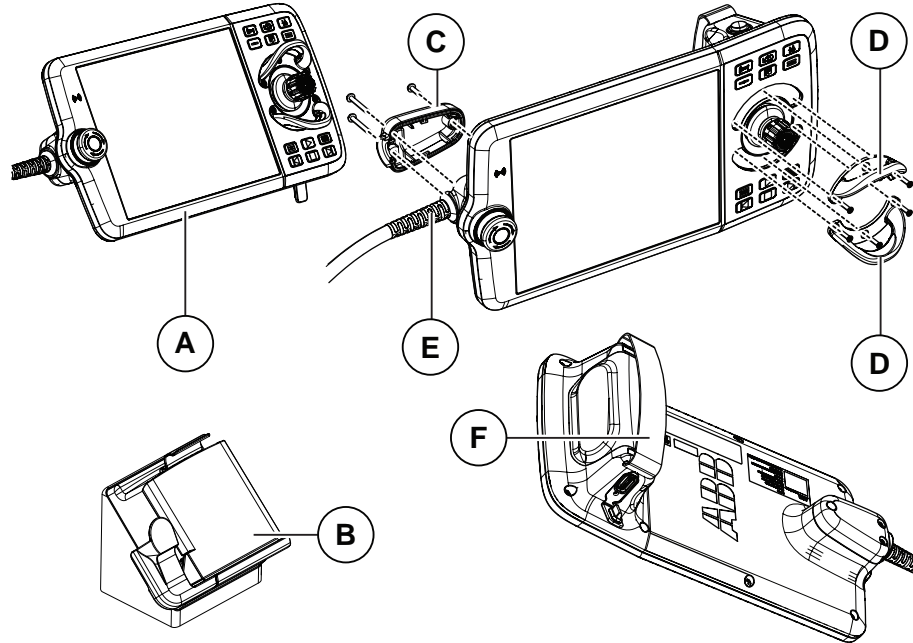

xx180000974

	Spare part number	Description	Type	Spare part level
A	3HAC086996-001	FlexPendant	DSQC3124	L1
B	3HAC064927-001	FlexPendant Holder w/t E-stop cover		L1
C	3HAC065401-001	Power cable cover		L1
D	3HAC065408-001	Joystick guard		L1
E	3HAC064448-002	FlexPendant power cable 3 m		L1
	3HAC064448-001	FlexPendant power cable 10 m		L1
	3HAC064448-003	FlexPendant power cable 30 m		L1
F	3HAC065419-001	Fasten strip		L1
-	3HAC068915-001	FlexPendant extension cable, 15 m		L1
-	3HAC068915-002	FlexPendant extension cable, 22 m		L1
-	3HAC068915-005	FlexPendant extension cable, 30 m		L1

9.3 Manipulator cables

9.3.1 Manipulator cables

Power cables, IRB 1100, 1300, 910INV, 920, 930, CRB 1300

Power cable length	Article number	Spare part level
Power cable, straight connector, 3 m	3HAC077245-001	L1
Power cable, straight connector, 7 m	3HAC077245-002	L1
Power cable, straight connector, 15 m	3HAC077245-003	L1
Power cable, angled connector, 3 m	3HAC077247-001	L1
Power cable, angled connector, 7 m	3HAC077247-002	L1
Power cable, angled connector, 15 m	3HAC077247-003	L1

Power cables, IRB 1200

Power cable length	Article number	Spare part level
Power cable 3 m	3HAC061139-001	L1
Power cable 7 m	3HAC061139-002	L1
Power cable 15 m	3HAC061139-003	L1

Signal cables, IRB 1100, 1300, 910INV, 920, 930, CRB 1300

Signal cable length	Article number	Spare part level
Signal cable, shielded: 3 m	3HAC084767-001	L1
Signal cable, shielded: 7 m	3HAC084767-002	L1
Signal cable, shielded: 15 m	3HAC084767-003	L1

Signal cables, IRB 1200

Signal cable length	Article number	Spare part level
3 m	3HAC080671-001	L1
7 m	3HAC080671-002	L1
15 m	3HAC080671-003	L1

9 Spare parts

9.3.2 Customer cables - CP/CS connectors (option)

9.3.2 Customer cables - CP/CS connectors (option)

CP/CS cables, IRB 1100, 1300, 910INV, 920, 930

CP/CS cable length	Article number	Spare part level
3 m	3HAC067449-001	L1
7 m	3HAC067449-002	L1
15 m	3HAC067449-003	L1

CP/CS cables, CRB 1300

CP/CS cable length	Article number	Spare part level
3 m, with lamp unit cabling	3HAC078069-001	L1
7 m, with lamp unit cabling	3HAC078069-002	L1
15 m, with lamp unit cabling	3HAC078069-003	L1

9.3.3 Customer cables - Ethernet floor cables

Ethernet floor cables, IRB 1100, 1300, 910INV, 920, 930 (option)

One end is RJ45, one end is X-code.

Ethernet floor cable length	Article number	Spare part level
Eth.RJ45_X floor cable, 7 m	3HAC067447-002	L1
Eth.RJ45_X floor cable, 15 m	3HAC067447-003	L1

Ethernet floor cables, CRB 1300 (option)

Ethernet floor cable length	Article number	Spare part level
7 m, with lead-through device cabling	3HAC077020-001	L1

This page is intentionally left blank

Index

3

3rd party software, 48

A

allergenic material, 30

aluminum

disposal, 380

ambient temperature

operation, 40

storage, 40

AS

configuring, 106

assembly instructions, 53

assessment of hazards and risks, 30

automatic mode, 29

automatic stop, 106

function test, 182

axis computer

LED, 425

replacing, 190

B

batteries

disposal, 380

bolt pattern, 60

brakes not releasing, 393

brominated flame retardants

disposal, 380

C

cabinet lock, 31

cables, 79

carbon dioxide extinguisher, 31

category 0 stop, 23

category 1 stop, 23

cleaning

FlexPendant, 46

cleaning of the controller, 172

cleaning the FlexPendant, 173

climbing on robot, 34

Connected Services gateway

replacing, 226

Connected Services Gateway

LED, 418

test equipment, 419

troubleshooting flowchart, 420

connection

manipulator cables, 79

controller

symbols, 20

controller fails to start, 402

controller mode, 402

cooling fan

replacing, 196

copper

disposal, 380

D

damaged bearings, 404

damaged parallel bar, 404

detaching FlexPendant, 87

DeviceNet

installing, 134

dimensions, 39

disconnecting FlexPendant, 87

disposal of storage media, 379

double SMB harness

installing, 116

drive unit

LED, 409

replacing, 284

E

earth fault protection, 83

emergency stop, 23

function test, 178

emergency stops, 25

enabling device, 26

function test, 180

EN ISO 13849-1, 16

environmental information, 380

ESD

damage elimination, 44

sensitive equipment, 44

esd elimination, 45

Ethernet

installing, 123

Ethernet extension switch

installing, 123

Ethernet switch

LED, 424

replacing, 222

external I/O

installing, 120

replacing, 234

F

fan

replacing, 196

faulty calibration, 404

faulty TCP definition, 404

fieldbus adapter

installing, 130

fieldbus adapter slave

LED, 436

fieldbus master

installing, 133

replacing, 292

fire extinguishing, 31

firmware, reflashing failure, 403

FlexPendant

blue screen, 397

cleaning, 46

connecting, disconnecting, 87

storage, 46

FlexPendant connector, 148, 154, 311, 334, 340, 349

FlexPendant holder, 63

FlexPendant joystick not working, 401

FlexPendant not responding, 397

FlexPendant not starting, 397

function tests, 178

G

general stop, 106, 183

GS

configuring, 106

H

hanging

installed hanging, 30

harness double SMB

- installing, 116
- hazard levels, 18
- hazardous material, 380
- height
 - installed at a height, 30
- hold-to-run, 26
- hot surfaces, 34
- HRA, 30

I

- I/O connectors, 101
- industrial network, 113
- installation activities, 54
- installation space, 58
- instructions for assembly, 53
- integrator responsibility, 30
- internal I/O
 - installing, 120
 - replacing, 234

J

- jogging not possible, 401
- joystick not working, 401

K

- key of the mode switch, 33

L

- labels
 - controller, 20
- lead
 - disposal, 380
- LED
 - axis computer, 425
 - Connected Services Gateway, 418
 - drive unit, 409
 - Ethernet switch, 424
 - fieldbus adapter slave, 436
 - main computer, 427
 - power supply, 430
 - power unit, 411
 - robot signal exchange proxy, 439
- LEDs , indication, 386
- LEDs not lit, 386
- licenses, 48
- lifting device, 55
- limitation of liability, 15
- Lithium
 - disposal, 380
- lock and tag, 31

M

- main computer
 - LED, 427
 - replacing, 243
- main power supply, 102, 104
- maintenance schedule, 167
- manipulator cables, 79
- manual full speed mode, 27
- manual high speed mode, 27
- manual mode, 27
- manual reduced speed, 27
- mode switch key, 33
- motor contactors
 - function test, 181
- MTTF_D, 16, 43

N

- national regulations, 30
- network security, 47
- noise, 404
- normal operation mode, 402

O

- open source software, OSS, 48
- operating conditions, 40
- operating mode
 - automatic mode, 29
 - function test, 179
 - manual full speed mode, 27
 - manual mode, 27
 - manual reduced speed, 27
- optional power supply
 - installing, 126
- original spare parts, 15

P

- path accuracy, 404
- pedestal
 - installed on pedestal, 30
- performance level, PL, 16
- personnel
 - requirements, 17
- PFH_D, 16, 43
- PL, performance level, 16
- plastic
 - disposal, 380
- power failure during start-up, 389
- power supply, 435
 - LED, 430
 - replacing, 277
 - test equipment, 431
 - troubleshooting flowchart, 432
- power supply optional
 - installing, 126
- power unit
 - LED, 411
 - replacing, 272
 - test equipment, 412
 - troubleshooting flowchart, 413
- PPE, 17
- problem releasing the robot brakes, 393
- process power supply, 435
 - DC OK, 435
 - LED, 435
- product standards, 446
- protection classes, 40
- protection type, 40
- protective earth, 84
- protective equipment, 17
- protective stop
 - definition, 23
- protective wear, 17

R

- RCD, 83
- recovering from emergency stops, 25
- recycling, 380
- reduced speed control
 - function test, 186
- reflashing firmware failure, 403
- regional regulations, 30
- remote I/O
 - installing, 120

- replacing, 234
- replacements, report, 187
- report replacements, 187
- required performance level, PLr, 16
- residual current device, 83
- responsibility and validity, 15
- risk of burns, 34
- robot
 - protection class, 40
 - protection types, 40
- robot signal exchange proxy
 - connectors, 92
 - LED, 439
 - replacing, 216
 - test equipment, 440
 - troubleshooting flowchart, 441
- RobotWare Installation Utilities mode, 402
- rubber
 - disposal, 380
- S**
- safeguarding, 23
- safeguard mechanisms
 - automatic mode, 29
 - manual mode, 27
- safety
 - ESD, 44
 - fire extinguishing, 31
 - signals, 18
 - signals in manual, 18
 - stop functions, 23
 - symbols, 18
 - symbols on controller, 20
- safety devices, 31
- safety digital base
 - replacing, 239
- safety signals
 - in manual, 18
- safety standards, 446
- scalable I/O, 115
 - connectors, 101
 - installing, 120
 - replacing, 234
- scalable I/O external, 115
- scalable I/O internal, 115
- shipping, 379
- signals
 - safety, 18
- sim card

- replacing, 226
- software licenses, 48
- standards, 446
 - ANSI, 446
 - CAN, 446
- steel
 - disposal, 380
- stop category 0, 23
- stop category 1, 23
- stops
 - overview, 23
- storage conditions, 40
- switch
 - Ethernet Extension, 123
- symbols
 - safety, 18
- system integrator requirements, 30
- system update failure, 392

T

- teach pendant
 - detach, attach, 87
- temperatures
 - operation, 40
 - storage, 40
- three-position enabling device, 26
 - function test, 180
- tightening torque, 449
- TPU
 - connecting, disconnecting, 87
- transportation, 379
- transportation conditions, 40
- troubleshooting
 - safety, 35

U

- upcycling, 380
- users
 - requirements, 17

V

- validity and responsibility, 15

W

- weight, 39
- wrist strap, 45

X

- X45 IP20, 102, 104



ABB AB

Robotics & Discrete Automation

S-721 68 VÄSTERÅS, Sweden

Telephone +46 10-732 50 00

ABB AS

Robotics & Discrete Automation

Nordlysvegen 7, N-4340 BRYNE, Norway

Box 265, N-4349 BRYNE, Norway

Telephone: +47 22 87 2000

ABB Engineering (Shanghai) Ltd.

Robotics & Discrete Automation

No. 4528 Kangxin Highway

PuDong New District

SHANGHAI 201319, China

Telephone: +86 21 6105 6666

ABB Inc.

Robotics & Discrete Automation

1250 Brown Road

Auburn Hills, MI 48326

USA

Telephone: +1 248 391 9000

abb.com/robotics